

ENVIRONMENTAL EXPRESS
oakton

Instruction Manual

pH/ORP METER

PH250

PH260

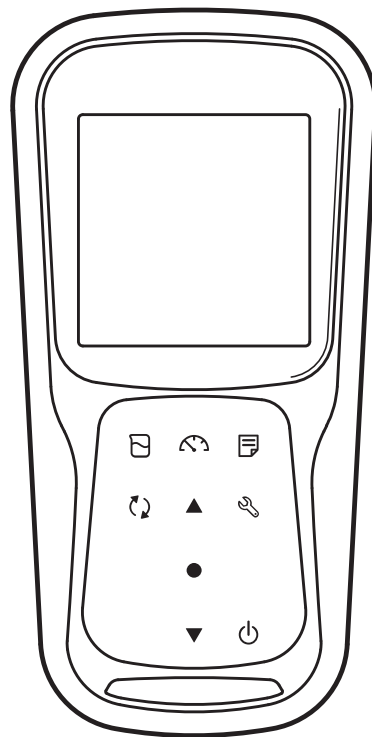

Preface

This manual describes the operation of the following instrument.

Brand: OAKTON
Series name: Water Quality Meter
Model: PH250, PH260
Model description: pH/ORP Meter

Be sure to read this manual before using the product to ensure proper and safe operation of the product. Also, safely store the manual so it is readily available whenever necessary. Product specifications and appearance, as well as the contents of this manual are subject to change without notice.

Warranty and responsibility

Oakton Instruments warrants that the product shall be free from defects in material and workmanship and agrees to repair or replace free of charge, at option of Oakton Instruments., any malfunctioned or damaged product attributable to responsibility of Oakton Instruments. for a period of Three (3) years from the delivery unless otherwise agreed in a written statement. In any one of the following cases, none of the warranties set forth herein shall be extended:

Any malfunction or damage attributable to improper operation

Any malfunction attributable to repair or modification by any person not authorized by Oakton Instruments.

Any malfunction or damage attributable to the use in an environment not specified in this manual

Any malfunction or damage attributable to violation of the instructions in this manual or operations in the manner not specified in this manual

Any malfunction or damage attributable to any cause or causes beyond the reasonable control of Oakton Instruments. such as natural disasters

Any deterioration in appearance attributable to corrosion, rust, and so on

Replacement of consumables

Oakton Instruments. SHALL NOT BE LIABLE FOR ANY DAMAGES RESULTING FROM ANY MALFUNCTIONS OF THE PRODUCT, ANY ERASURE OF DATA, OR ANY OTHER USES OF THE PRODUCT.

Trademarks

Microsoft, Windows, Windows Vista are registered trademarks or trademarks of Microsoft Corporation in the United States and other countries.

Other company names and brand names are either registered trademarks or trademarks of the respective companies. (R), (TM) symbols may be omitted in this manual.

CODE:M003808-3200828205-GZ0000581078
November,2019 © 2019 Oakton Instruments.

Regulations

Regulations

EU regulations

Conformable standards

This equipment conforms to the following standards:



EMC: EN61326-1
Class B, Basic electromagnetic environment
RoHS: EN50581
9. Monitoring and control instruments

Warning: This product is not intended for use in industrial environments. In an industrial environment, electromagnetic environmental effects may cause the incorrect performance of the product in which case the user may be required to take adequate measures.

Information on disposal of electrical and electronic equipment and disposal of batteries and accumulators

The crossed out wheeled bin symbol with underbar shown on the product or accompanying documents indicates the product requires appropriate treatment, collection and recycle for waste electrical and electronic equipment (WEEE) under the Directive 2012/19/EU, and/or waste batteries and accumulators under the Directive 2006/66/EC in the European Union. The symbol might be put with one of the chemical symbols below. In this case, it satisfies the requirements of the Directive 2006/66/EC for the object chemical. This product should not be disposed of unsorted household waste. Your correct disposal of WEEE, waste batteries and accumulators will contribute to reducing wasteful consumption of natural resources, and protecting human health and the environment from potential negative effects caused by hazardous substance in products.

Contact your supplier for information on applicable disposal methods.

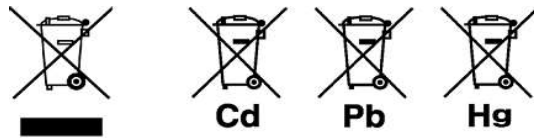

Regulations

Authorised representative in EU

FCC rules

FCC Compliance Statement

This device complies with part 15 of the FCC Rules. Operation is subject to the following two conditions: (1) This device may not cause harmful interference, and (2) this device must accept any interference received, including interference that may cause undesired operation.

Responsible Party for FCC matter

Note

This equipment has been tested and found to comply with the limits for a Class A digital device, pursuant to part 15 of the FCC Rules. These limits are designed to provide reasonable protection against harmful interference when the equipment is operated in a commercial environment. This equipment generates, uses, and can radiate radio frequency energy and, if not installed and used in accordance with the instruction manual, may cause harmful interference to radio communications. Operation of this equipment in a residential area is likely to cause harmful interference in which case the user will be required to correct the interference at his own expense.

Any changes or modifications not expressly approved by the party responsible for compliance could void the user's authority to operate the equipment.

For Your Safety

For Your Safety

Hazard classification and warning symbols

Warning messages are described in the following manner. Read the messages and follow the instructions carefully.

Hazard classification



This indicates an imminently hazardous situation which, if not avoided, will result in death or serious injury. This is to be limited to the most extreme situations.



This indicates a potentially hazardous situation which, if not avoided, could result in death or serious injury.



This indicates a potentially hazardous situation which, if not avoided, may result in minor or moderate injury. It may also be used to alert against unsafe practices.

Warning symbols



Description of what should be done, or what should be followed.



Description of what should never be done, or what is prohibited.

For Your Safety

Safety precautions

This section provides precautions for using the product safely and correctly and to prevent injury and damage. The terms of DANGER, WARNING, and CAUTION indicate the degree of immanency and hazardous situation. Read the precautions carefully as it contains important safety messages.

Instrument and electrode

WARNING



Do not disassemble or modify the instrument. Otherwise, it may heat up or be ignited resulting in a fire or an accident.

CAUTION



Harmful chemicals

Some electrodes are used with hazardous standard solutions. Handle them with care.

The internal solution of pH electrode is highly concentrated potassium chloride (3.33 mol/L KCl). If the internal solution comes in contact with the skin, wash it off immediately. If it gets into the eyes, flush with plenty of water and then consult a doctor.



Broken glass

Broken glass may cause injury. The outer tube and tip of an electrode are made of glass. Handle them with care.



Do not use the phono jack under wet or humid conditions. Otherwise, it may cause a fire, electric shock, or breakage.

For Your Safety

Battery

WARNING



Keep batteries out of reach of children. If someone accidentally swallows a battery, consult a doctor immediately.



If alkaline fluid from a battery gets into the eyes, do not rub the eyes, rinse with clean water immediately and then consult a doctor. Contact with alkaline fluid could cause blindness.



Do not put batteries in a fire, expose to heat, disassemble or remodel. Doing so can cause fluid leakage, overheating or explosion.

Product Handling Information

Product Handling Information

Operational precautions (instrument)

Only use the product including accessories for their intended purpose.

Do not drop or physically impact the instrument.

The instrument is made of solvent-resistant materials but that does not mean it is resistant to all chemicals. Do not expose the instrument in strong acid or alkali solution, or wipe with such solution.

If the instrument is dropped into water or gets wet, wipe it using soft cloth. Do not heat to dry it.

The instrument has a dust-proof and waterproof structure i.e., the instrument does not malfunction even when immersed in water of 1 m depth for 30 minutes. This does guarantee non-destructive, trouble-free, dust-proof, and waterproof performance in all situations.

When replacing the batteries or when a serial cable connected, the instrument does not have the dust-proof and waterproof performance. The dust-proof and waterproof performance is maintained only when the covers are attached correctly.

After replacing the batteries or removing the serial cable connected, make sure that the waterproof gasket attached to the cover is not deformed or discolored, or has foreign matter adhering to it. If the waterproof gasket is deformed, discolored or has foreign matter adhering to it, dust could get inside, water leaks could occur that could lead to instrument malfunction.

To disconnect an electrode or serial cable, hold the connector and pull it off. If you pull at the cable, it may cause breakage.

The phono jack communication between the instrument and a personal computer (referred to as PC in the rest of this document) may fail because of environmental conditions, such as electromagnetic noise.

Do not replace the batteries in a dusty place or with wet hands. Dust or moisture could get inside the instrument, possibly causing instrument malfunction.

Do not use an object with a sharp end to press the keys.

If the power supply is interrupted while measurement data is being saved in the instrument, the data could be corrupted.

A Ni-MH rechargeable battery can be used in this instrument.

Operational precautions (battery)

Do not short circuit a battery.

Position the + and – side of the battery correctly.

When the battery has depleted or the instrument will not be used for a long time, remove the batteries.

Of the specified battery types, make sure to use two batteries of the same type.

Do not use a new battery together with a used battery.

Do not use a fully charged nickel-metal hydride battery together with a partially charged battery.

Do not attempt to charge a non-rechargeable battery.

Product Handling Information

Environmental conditions for use and storage

Temperature: 0 °C to 45 °C

Humidity: under 80% relative humidity and free from condensation

Avoid the following conditions:

Strong vibration

Direct sunlight

Corrosive gas environment

Locations close to an air-conditioner

Direct wind

Transportation

When transporting the instrument, repackage it in the original package box. Otherwise, it may cause instrument damage.

Disposal

Standard solution used for the calibration must be under neutralized before the disposal.

When disposing of the product, follow the related laws and regulations of your country for disposal of the product.

X

Contents

■ Product Overview	1
● Package Content	1
● Key Features	2
● Product components	3
■ Basic operations	7
● Mode and measurement	9
■ Calibration	11
● pH Calibration	11
● ORP/mV Calibration	13
● Temperature Calibration	15
■ Data	17
● Data capture and storage	17
● Data transfer	18
■ Setup	19
● P1 pH setup	19
● P2 Data setup	23
● P3 General setup	27
● P4 CLK setup	32
■ Maintenance and storage	35
● Maintenance and storage of the instrument	35
● Maintenance and storage of pH and ORP electrodes	
36	
■ Error messages and trouble shooting	38
■ Appendix	42
● Appendix 1	42
● Appendix 2	44
● Appendix 3	47

■ Product Overview

This section describes the package content, key features and product components of OAKTON PH200 series Handheld meters.

● Package Content

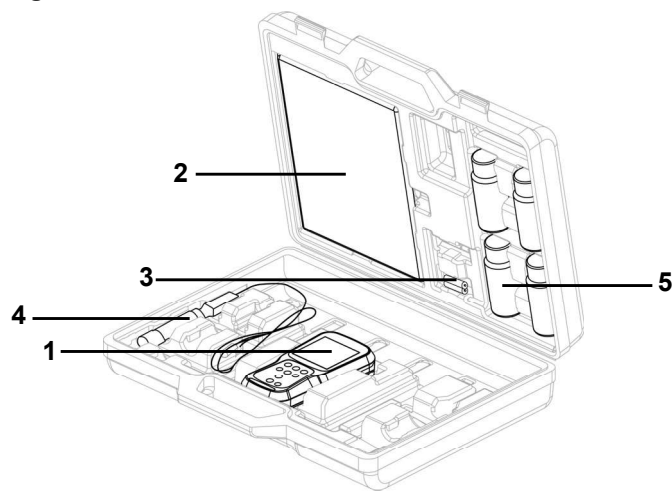

After opening the carry case, remove the meter and check for damage on the instrument and confirm that the standard accessories all exist. If damage or defects are found on the product, contact your dealer.

OAKTON PH200 series Handheld meters kit include the following items:

S.NO.	Name
1	Instrument
2	Instruction manual
3	2 AA batteries
4	Electrode (Electrode kit only)
5	Calibrating solutions

Product overview

• Key Features

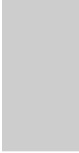
- 
- IP67 water ingress, dust-proof, shock-resistant, anti-slip meter housing.
 - Large monochrome LCD (50 x 50 mm) with white LED back lighting.
 - Built-in electrode holder (up to 2 electrodes).
 - Foldable meter stand.
 - Simple user interface and single parameter display.
 - 500 (for PH250) / 1000 (for PH260) data memory.
 - Automatic Temperature Compensation (ATC) with temperature calibration.
 - Adjustable auto shut-off time (1 to 30 minutes).
 - Auto-hold / Auto stable / Real-time measurement modes with stability indicators.
 - Powered by 2 x AA batteries.
 - Real-time clock (only for PH260).
 - PC (standard USB) / Printer (25 pin serial) connection via 2.5 mm diameter phono jack.

• Product components

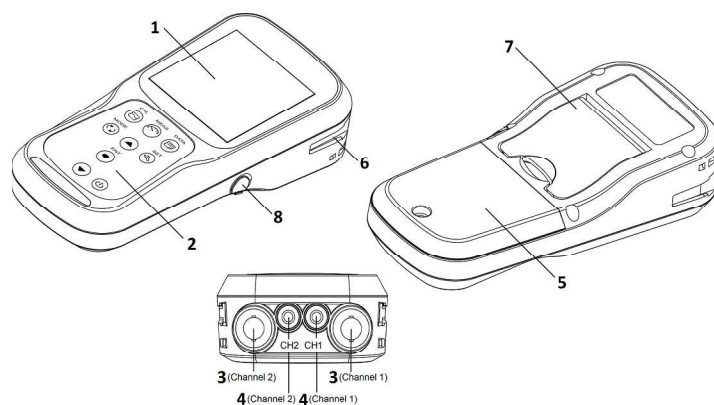





No	Name	Function
1	Monochrome LCD	Displays the measured value
2	Operation keys	Used for instrument operation
3	Electrode connector	Connect to the BNC connector of the electrode
4	Temperature connector (T)	Connect to the temperature sensor of the electrode
5	Battery cover	Open/close to insert/remove batteries
6	Electrode holder	Hold the electrode to carry with the instrument
7	Meter stand	Open stand to place the meter at an inclined position on a flat surface
8	Serial connector	Connects the serial cable and printer cable

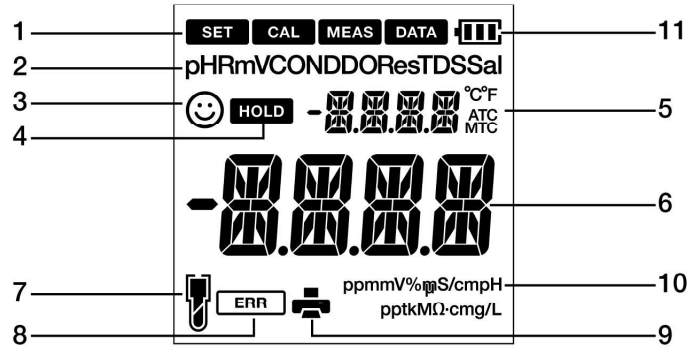



Product overview

• Display





No	Name	Function
1	Status Icon	Displays the current operation mode (Setup, Calibration, Measurement and Data mode)
2	Parameters	Displays the measured parameters like pH and RmV
3		Stability indicator shows value is stable for documentation in Auto Stable and Auto Hold modes
4	HOLD	Appears when the measured value display is stable and fixed in auto-hold mode
5	Temperature display area	Displays the measured temperature
6	Measured value, set item display area	Displays the measured value and the set value
7		Indicates electrode sensitivity level
8	ERR	Indicates error situation
9		Indicates data being transferred to the printer or computer
10	ppmmV% μS/cm pH pptkMΩ-cmg/L	Displays the unit for the measurement parameter
11		Displays the battery level

● **Battery level display**

	100% battery life
	50% battery life
	20% battery life
	Batteries are weak and need replacement. Refer BATT LOW (page 38) to solve this

● **Electrode sensitivity level**

	Electrode sensitivity above 95%(excellent)
	Electrode sensitivity between 85% to 95% (very good)
	Electrode sensitivity between 80% to 85%(good). Refer SLPE ERR (page 38) to solve this

• Keypad operation

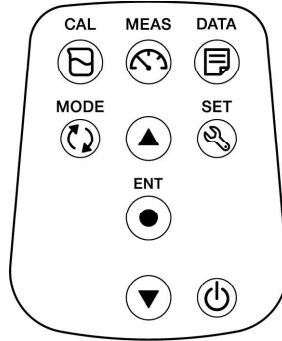

Keypad	Name	Function
	CAL key	Switches from the measurement mode to the calibration mode. Starts calibration in the calibration mode.
	MEAS key	Switches the operation mode to the measurement mode. Releases the fixed measurement value mode in the auto hold mode and begins a new measurement.
	DATA key	Switches from the measurement mode to the data mode.
	MODE key	In the measurement mode, changes measurement parameters.
	SET key	Switches from the measurement mode to the setup mode.
	ENTER key	Determines the selection or setup. Saves data in the measurement mode and calibration mode.
	UP key	In the setup mode, navigates between various setups. Selects preferred option in some setup screens.
	DOWN key	Increases or decreases selected digit when entering numbers.
	POWER key	Powers ON/OFF the instrument.

■ Basic operations

This section describes function and basic operation method of each part of OAKTON PH200 series Handheld meters.

● Turning on the instrument

Inserting the batteries

This instrument is operated by batteries. You can use AA alkaline batteries or AA Ni- MH chargeable batteries. Perform the following procedure to insert batteries in the instrument.

1. Unscrew the battery cover on the back of the instrument counter-clock wise to unlock the battery cover.
2. Remove the battery cover and set the batteries inside.
3. Replace battery cover.
4. Screw the battery cover on the back of the instrument clockwise to lock the battery cover.

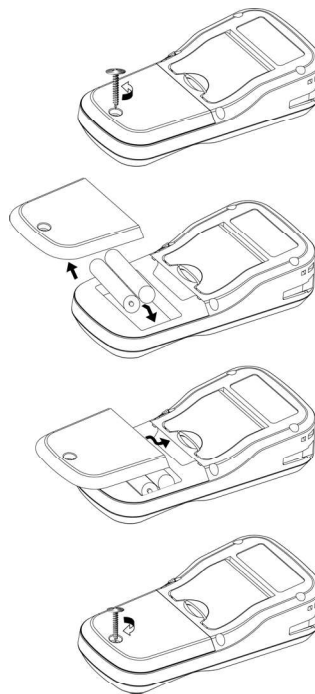

Note

Do not replace the batteries in a dusty place or with wet hands. Dust or moisture could get inside the instrument and possibly cause an instrument malfunction.

Do not short-circuit a battery.

Note polarity as shown in the battery compartment.

When the battery has depleted or the instrument is not used for a long time, remove the batteries.

Of the specified battery types, make sure to use two batteries of the same type.

Do not use a new battery together with an used battery.

Basic operations

• Connecting an electrode

To perform calibration/ measurement, it is necessary to use the appropriate electrode for measurement parameter. Recommended electrodes for various sample are listed in our product catalog. Use the following procedure to correctly connect the electrode to the instrument:

1. Insert the electrode connector by fitting its groove with the connector pin of the instrument.
2. Turn the electrode connector clockwise by following the grooves.
3. Slide the connector cover on the connector.
4. When using a combination electrode equipped with a temperature sensor, insert the temperature jack (T) to the ATC socket on the meter.

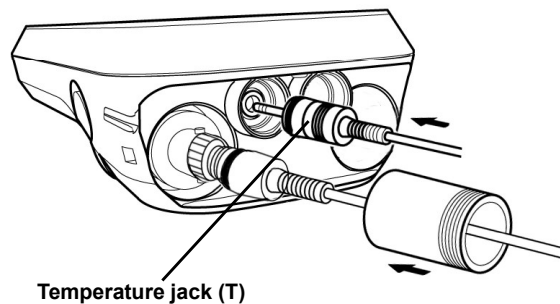
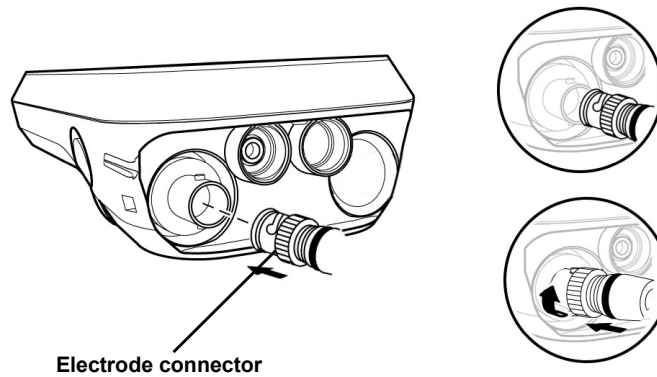

- **Mode and measurement**
- **Changing the operation mode**

You can change the operation mode to four available modes depending on the purpose of use. The status icon indicates the current mode.

Status icons ——— **SET** **CAL** **MEAS** **DATA**

Icon	Name	Function
SET	Setup mode	Perform various setup functions.
CAL	Calibration mode	Performs calibration.
MEAS	Measurement mode	Performs measurement.
DATA	Data mode	Performs data setup. Displays the saved data.

You can change the operation mode using the corresponding key:

Measurement mode: Press the  key to change to the measurement mode.

Calibration mode: In the measurement mode, press the  key to change to the calibration mode.

Data mode: In the measurement mode, press the  key to change to the data mode.

Setup mode: In the measurement mode, press the  key to change to the setup mode.

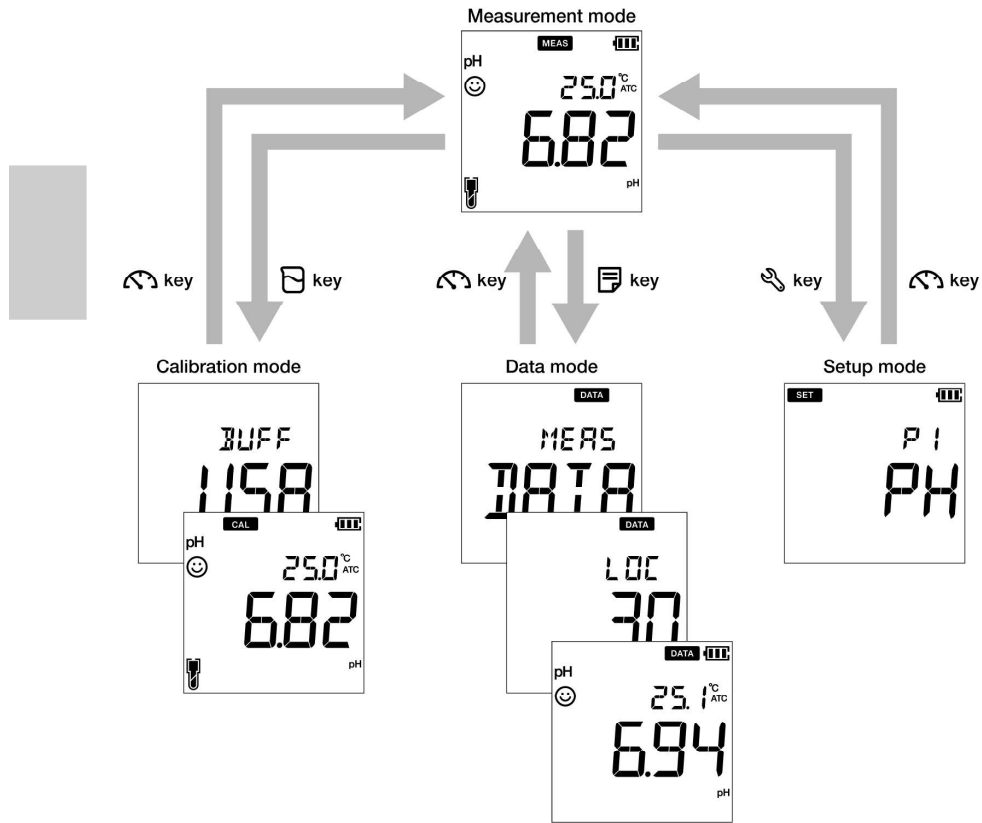

• **Changing the measurement parameter**

This instrument measures multiple parameters. For measurement, an electrode corresponding to the measurement parameter is required. In the measurement mode, the measurement parameter can be changed by pressing the  key.

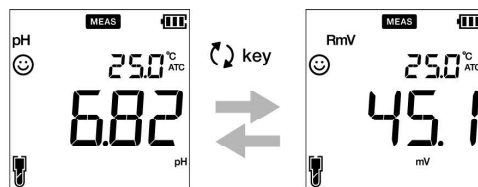

■ Calibration

This section describes the basic calibration method using OAKTON PH200 series Handheld meters and pH electrode.

● pH Calibration

Calibration is necessary for accurate pH measurement. To perform pH calibration, follow the procedure detailed below:

Prerequisites

Clean the pH electrode with DI (deionized) water and wipe it with tissue paper.
Switch on the pH meter and plug in the pH electrode.
Prepare buffer solution required for calibration.
Keep the meter in pH measurement mode.
Dip the pH electrode at least 3 cm in the buffer solution.

Note

Perform two-point calibration using:

pH 7 and 4 for acidic sample.

pH 7 and 10 for alkaline sample.

Perform three-point calibration using pH7, 4 and 10 if you are unsure of the expected sample pH value. It is recommended to calibrate with pH7 first.

Default buffer setup is **BUFF USA**. If you want to change to **BUFF NIST** or **BUFF DIN**, refer to P 1.1 Buffer selection on page 20.





Tip

To abort an ongoing calibration process at any point of time, press the  key.

It is recommended to clear the previous calibration data before performing calibration. For erasing the calibration data, refer to P 1.3 Erase calibration data on page 22.

pH calibration

Calibration

5. After placing the pH electrode in the buffer solution, press the  key.
6. The selected buffer standard appears on the meter screen and meter starts checking various calibration values with a blinking  on screen.
7. Wait for the  to stabilize (stable calibration reading).
8. Press the **ENT**  key to confirm and save calibration data.
9. Meter displays **DONE** indicating end of the pH calibration procedure.
10. Repeat for other calibration points as required.

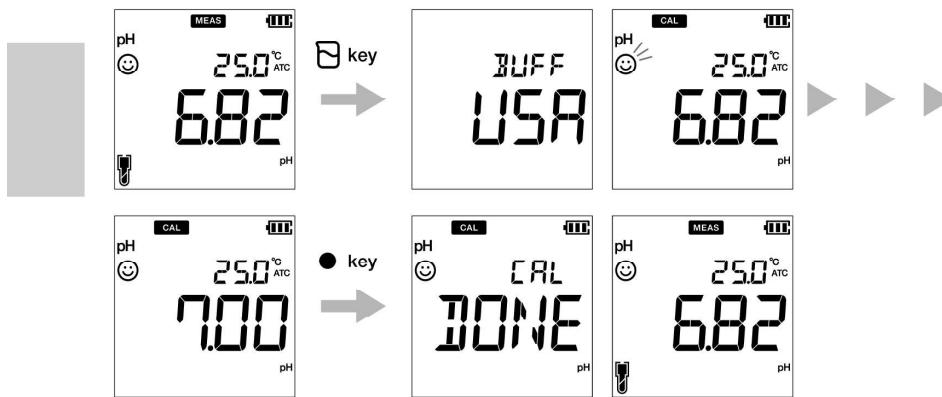

Note

If you want to know previous calibrated values, press the  key when you are in the **CAL** mode. The display scrolls through the calibrated values and indicates slope and offset values.

- **ORP/mV Calibration**

Calibration is necessary for accurate ORP measurement. To perform ORP calibration, follow the procedure detailed below:

Prerequisites

- Clean the ORP electrode with DI (deionized) water and wipe it with tissue paper.
- Switch on the pH meter and plug in the ORP electrode.
- Prepare buffer solution required for calibration.
- Ensure that the meter is in measurement mode.
- Dip the ORP electrode into the standard solution ensuring that the solution level is at least 3 cm from the electrode tip.

Note

Absolute value measurement mode and relative value measurement mode are the two types of measurement mode available for ORP (mV) measurement.

In absolute value measurement mode, the handheld meter displays the actual voltage value.

In relative value measurement mode, user can adjust the absolute mV value by calibration.

If the mV value is adjusted, the meter automatically indicates relative mV value as **RmV**.







The adjustment mV is applied as an offset to the absolute mV value.

In the relative mV mode, the absolute mV value can be adjusted by ± 200 mV.

Tip

To abort an ongoing calibration process at any point of time, press the  key.

Calibration

11. After placing the electrode in the solution, press the  key to switch to mV mode.
12. Press the  key.
13. Meter starts reading mV values and the  blinks until value stabilizes.
14. Wait for the  to stabilize (stable calibration reading).
15. Use the   keys to adjust the mV value to your desired value.
16. Press the **ENT**  key to confirm and save calibration data.
17. Meter displays **DONE** that indicates end of the ORP/mV calibration procedure.

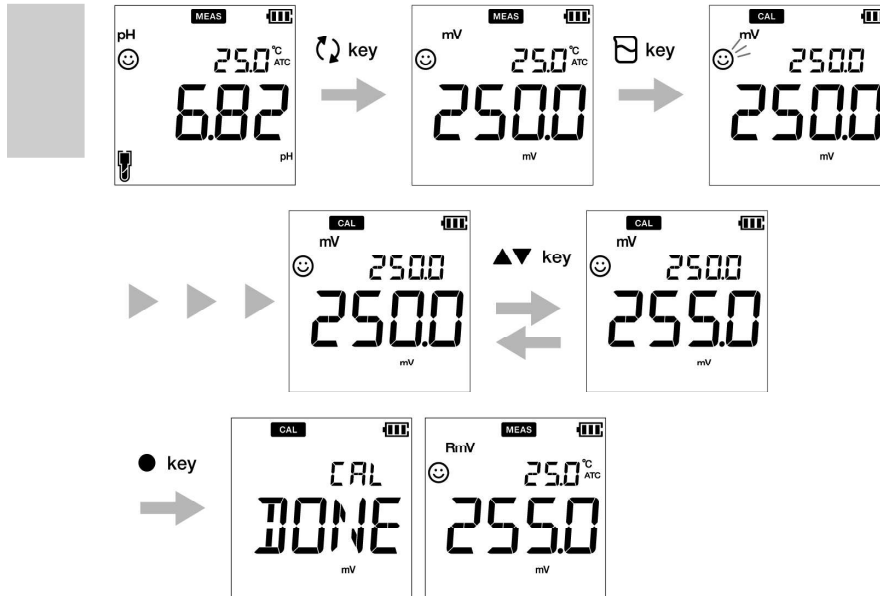

- **Temperature Calibration**

Temperature calibration is required to accurately match pH electrode to the meter. Check the temperature reading and if it is acceptable, no temperature calibration is required. If you need to calibrate, please follow the procedure detailed below:

Prerequisites

Clean the pH electrode with DI (deionized) water and wipe it with tissue paper.
Switch on the pH meter and plug in the pH electrode and temperature sensor.
Dip the pH electrode in any buffer solution till its temperature sensor is immersed.
Wait for 5 minutes to ensure temperature stability.

Note





Meter displays **MTC** if the temperature sensor is not plugged in and displays **ATC** if the temperature sensor is plugged in.
Temperature calibration must be performed using a known temperature solution or against a calibrated thermometer.

Tip

To abort an ongoing calibration process at any point of time, press the  key.

Temperature calibration

Calibration

18. After placing the electrode in the solution, press the  key.
19. Press the  key to switch to temperature calibration mode. Meter displays measured temperature value.
20. Use the   keys to adjust the temperature to the required value.
21. Press the **ENT**  key to save calibration data.
22. Meter displays **DONE** indicating end of the temperature calibration procedure.

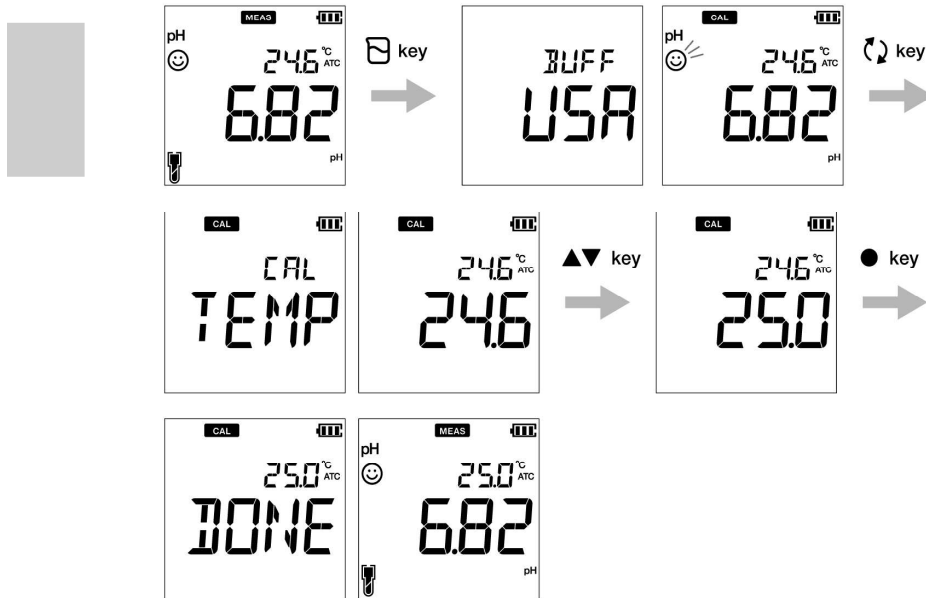

■ Data

This section describes the basic method of data storing and transferring using OAKTON PH200 series Handheld meters.

● Data capture and storage

In OAKTON 200 series Handheld meters, data measured by the instrument can be stored in the internal memory.

To save the measured data;

Press the **ENT**  key to save the displayed data.

Meter displays the saved data for 2 seconds and then the display returns to the previous screen automatically.

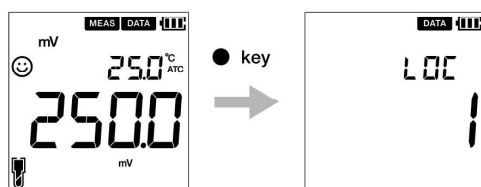

Note

If the data storage limit reaches 500 in PH250 model or 1000 in PH260 model, memory full error occurs and **MEM FULL** is displayed.

In such case, print the data or transfer necessary data to a PC (only for PH260) and delete the data from the internal memory of the instrument.

Viewing stored data

To view stored data, press  key.

Use   keys to review different stored records.

Press  key to return to measurement mode.

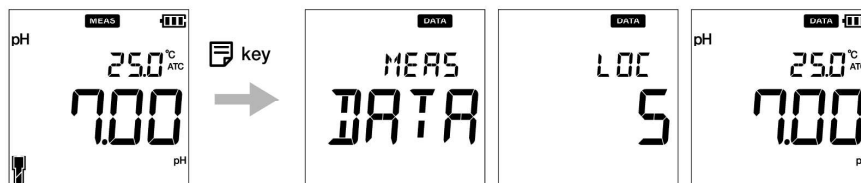

Data capture and storage

- **Data transfer**

- **Transfer data to PC**

Connect the instrument to a PC using the phono plug to USB cable to transfer saved data to the PC (for OAKTON PH260 only). Connect the phono jack at the instrument side to the communication port on the PC.

- **Print data**

To print a desired data set;

23. When in the measurement mode, press  key.

24. Use ▲ ▼ keys to view desired stored data.

25. Press ● key to print that individual data.

- **Printer format- data log**

Meter Model	: OAKTON PH260
Serial Number	: 123456789
SW Revision	: 1.00
User Name	:
Signature	:
Logged Data	
Location	: 2
Date	: 10 Aug 2018
Time	: 10:10:28
Mode	: pH
pH	: 7.00 pH
mV	: 0.0 mV
Temperature	: 25.0 C (MAN)
Electrode Status	: Excellent
Location	: 1
Date	: 10 Aug 2018
Time	: 10:09:28
Mode	: mV
mV	: 178.0 mV
Temperature	: 25.0 C (MAN)

Tip

To print entire stored data log, refer P 2.2 Print data setup on page 25.

■ Setup

This section describes all the setup functions available in OAKTON PH200 series Handheld meters.

● P1 pH setup

Using P1 pH setup function of the meter, you can:

- Select buffer standard
- Set calibration alarm
- Erase calibration data

To set the pH functions using OAKTON PH200 series Handheld meters, follow the procedure detailed below:

Prerequisites

Switch on the pH meter.

Note

Default buffer setup is **BUFF USA**. You can change it to **BUFF NIST** or **BUFF DIN** if required.

Calibration alarm setup option must be used to avoid Calibration interval alarm error on page 38. You can set the calibration alarm for ---- day to upto 90 days, where ---- indicates no calibration alarm has been set.







Erasing previous calibration data is recommended for accurate calibration. Default setup is **NO** but to erase the calibration data, you need to change the setup to **YES**.

Tip

To return to the measurement mode, press the  key.





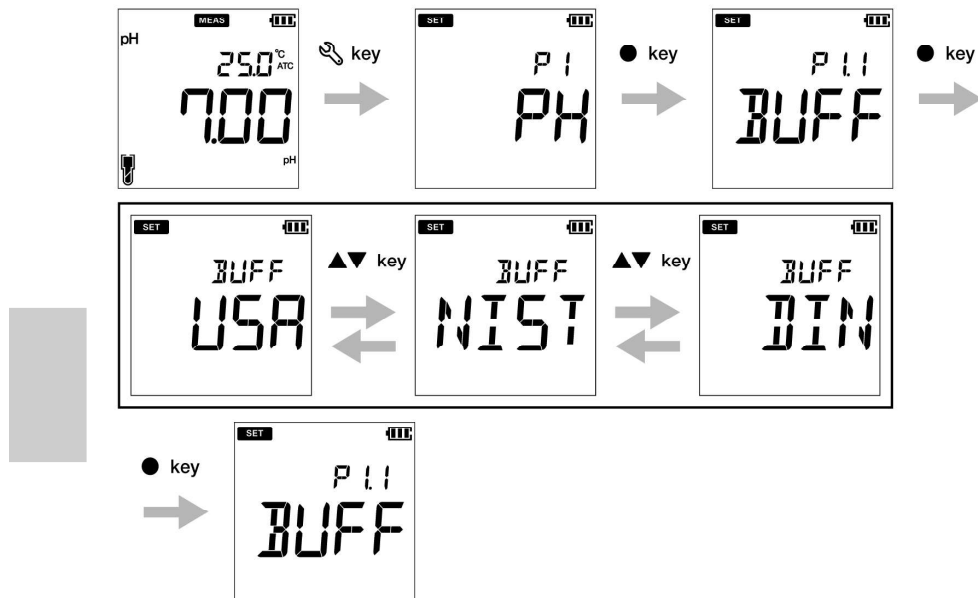

pH set up

• P 1.1 Buffer selection

26. Press the  key, P1 PH screen appears.
27. Press the **ENT**  key, P1.1 BUFF screen appears.
28. Press the **ENT**  key, by default **BUFF USA** appears.
29. Use the   keys to change the buffer standard to **BUFF NIST** or **BUFF DIN**.
30. Press the **ENT**  key, P1.1 BUFF screen appears. This indicates completion of buffer selection.







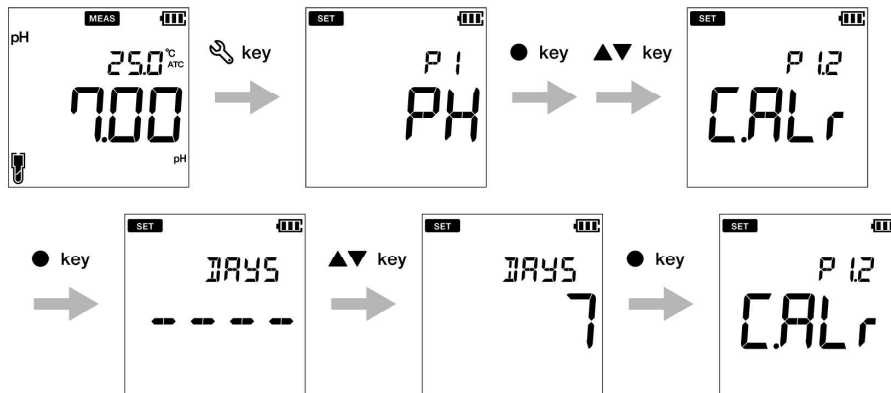



• P 1.2 Calibration alarm setup

1. Press the  key, **P1 PH** screen appears.
2. Press the **ENT**  key, **P1.1 BUFF** screen appears.
3. Press the  key, **P1.2 C.ALr** screen appears.
4. Press the **ENT**  key, by default **DAYS ----** appears.
5. Use the   keys to adjust the calibration alarm interval for next calibration.
6. Press the **ENT**  key, **P1.2 C.ALr** screen appears. This indicates completion of calibration alarm setup.



pH set up

• P 1.3 Erase calibration data

1. Press the  key, **P1 PH** screen appears.
2. Press the **ENT**  key, **P1.1 BUFF** screen appears.
3. Press the  key, **P1.2 C.ALr** screen appears.
4. Press the  key, **P1.3 C.CLr** appears.
5. Press the **ENT**  key, **C.CLr NO** screen appears with **NO** as default setup.
6. Use the   keys to change the setup to **YES**. This erases the calibration data.
7. Press the **ENT**  key. **P1.3 C.CLr** screen appears. This indicates erasure of calibration data.

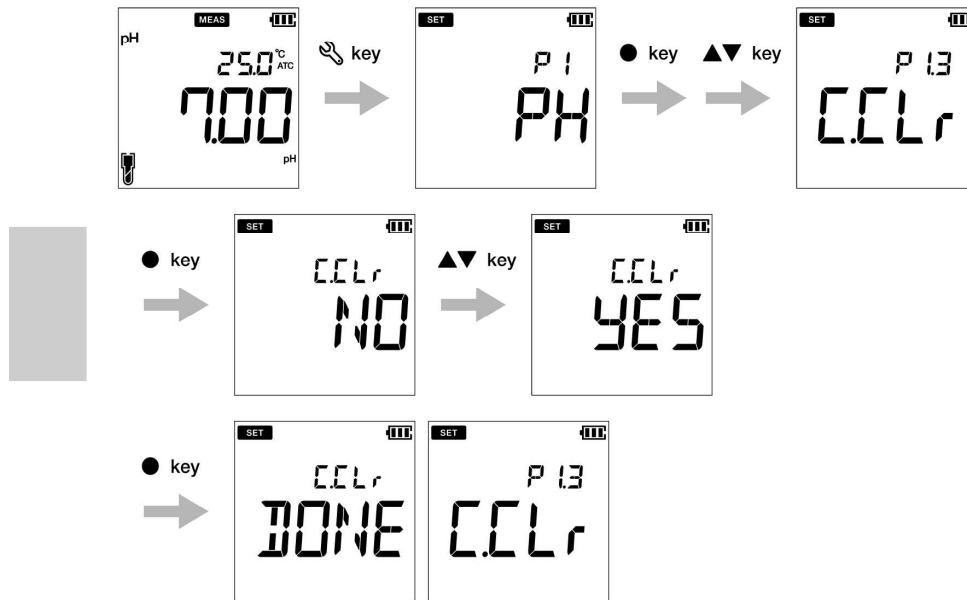

• **P2 Data setup**

Using P2 Data setup function of the meter, you can:

- Set data log interval
- Print data log
- Erase data log

To set the data functions using OAKTON PH200 series Handheld meters, follow the procedure detailed below:

Prerequisites

Switch on the pH meter.

Note







Data log interval can be set from 2 to 999 seconds.

Tip

To return to the measurement mode, press the  key.







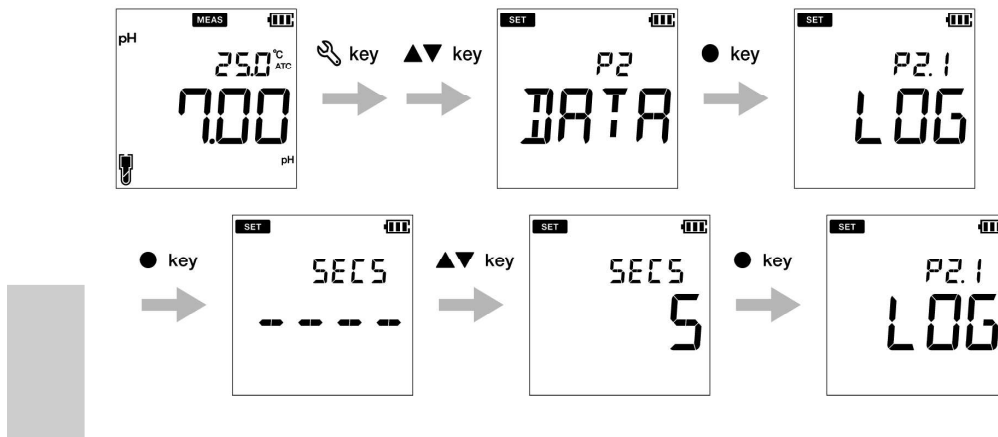

Data set up

• P 2.1 Data log interval setup

8. Press the  key, P1 PH screen appears.
9. Press the  key, P2 DATA screen appears.
10. Press the **ENT**  key, P2.1 LOG screen appears.
11. Press the **ENT**  key, previously set log interval appears.
12. Use the   keys to set the data log interval.
13. Press the **ENT**  key, P2.1 LOG screen appears. This indicates completion of data log interval setup.







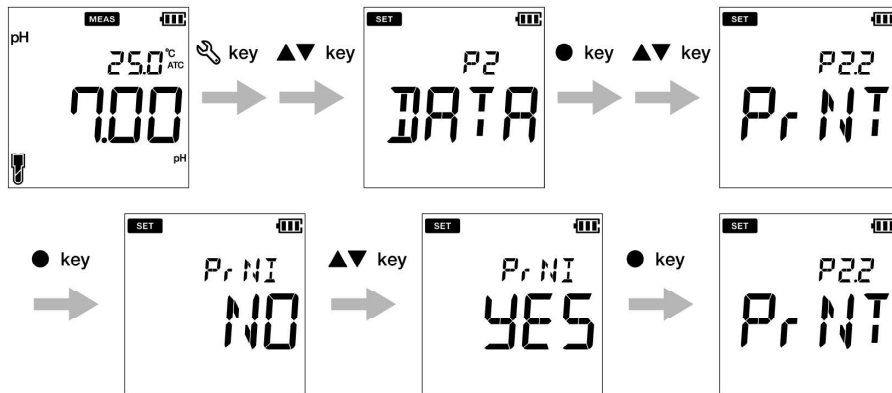



• P 2.2 Print data setup

1. Press the  key, **P1 PH** screen appears.
2. Press the  key, **P2 DATA** screen appears.
3. Press the **ENT**  key, **P2.1 LOG** screen appears.
4. Press the  key, **P2.2 PrNT** screen appears.
5. Press the **ENT**  key, default setup is **NO**.
6. Use the   keys to change the setup to **YES**.
7. Press the **ENT**  key, **P2.2 PrNT** screen appears. This indicates completion of the print data.



Data set up

• P 2.3 Erase data

1. Press the  key, **P1 PH** screen appears.
2. Press  key, **P2 DATA** screen appears.
3. Press the **ENT**  key, **P2.1 LOG** screen appears.
4. Press the  key, **P2.2 PRNT** screen appears.
5. Press the  key, **P2.3 D.CLR** screen appears.
6. Press the **ENT**  key, default setup is **NO**.
7. Use the   keys set it to **YES** to erase all the data.
8. Press the **ENT**  key, **D.CLR DONE** screen appears briefly and then **P2.3 D.CLR** screen appears. This indicates completion of erasure of data.

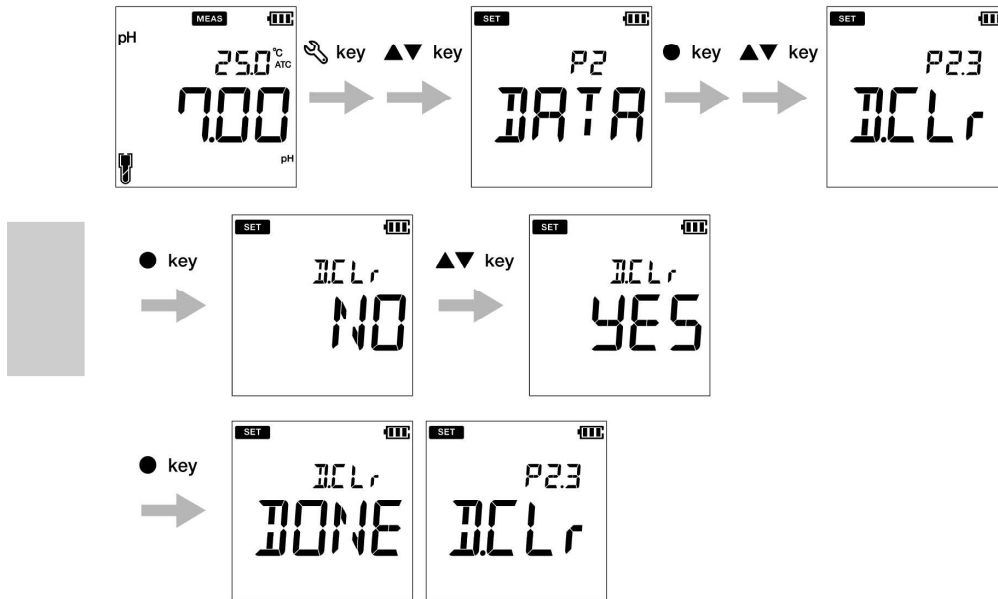

• **P3 General setup**

Using P3 General setup function of the meter, you can:

- Select stability mode of the meter
- Set auto shut-off time
- Select temperature measurement
- Reset the meter

To set the general functions using OAKTON PH200 series Handheld meters, follow the procedure detailed below:

Prerequisites

Switch on the pH meter.

Note

In the calibration mode, the auto stable (**AS**) mode is activated. Default stability setup in measurement mode is auto stable (**AS**). If you like, you can change it to auto hold (**AH**) or real time (**RT**).

Default auto shut-off time is 30 minutes. You can set the time from ---- to 30 minutes, where ---- indicates no auto shut-off time has been set and meter will be on continuously.

Default temperature unit is °C and you can change the unit to °F.

Default reset meter setup is **NO**. If you like to reset the meter, you can change it to **YES**.

Tip

Stability judgment criteria remains same for both auto stability mode and auto hold mode.

To return to the measurement mode, press the  key.









General set up

• P 3.1 Auto Stable, Auto Hold and Real Time mode setup

Auto Stable (AS) mode - the meter shows live readings ☺ annunciator blinks until the reading is stable.







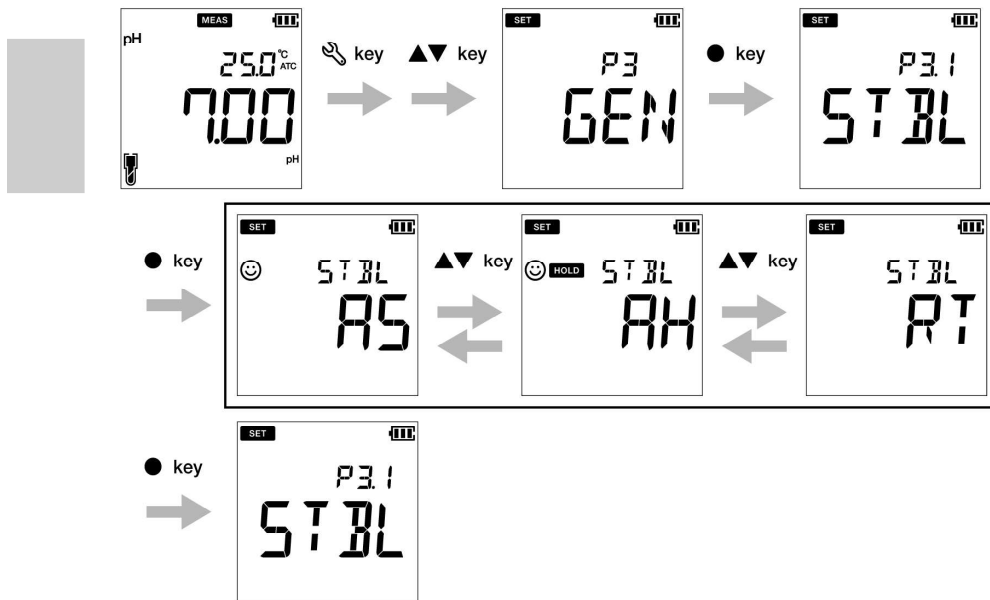

Auto Hold (AH) mode - the meter locks the stable reading; ☺ annunciator blinks until reading is stable and then **HOLD** lights up.

Real Time (RT) mode - the meter shows live readings; Both ☺ and **HOLD** annunciators are inactive.

9. Press the  key, **P1 PH** screen appears.
10. Press  key, **P2 DATA** screen appears.
11. Press  key, **P3 GEN** screen appears.
12. Press the **ENT**  key, **P3.1 STBL** screen appears.
13. Press the **ENT**  key, Default the stability mode is **AS** (auto stable).
14. Use the   keys to change the stability mode as **AH** (auto hold) or **RT** (real time).
15. Press the **ENT**  key, **P3.1 STBL** screen appears. This indicates completion of the stability mode selection.



● **P 3.2 Auto shut-off time setup**

1. Press the  key, **P1 PH** screen appears.
2. Press the  key, **P2 DATA** screen appears.
3. Press the  key, **P3 GEN** screen appears.
4. Press the **ENT**  key, **P3.1 STBL** screen appears.
5. Press the  key, **P3.2 A.OFF** screen appears.
6. Press the **ENT**  key, default auto shut-off time is **30 minutes**.
7. Use the   keys to adjust the auto off time.
8. Press the **ENT**  key, **P3.2 A.OFF** screen appears. This indicates completion of the auto shut-off time setup.





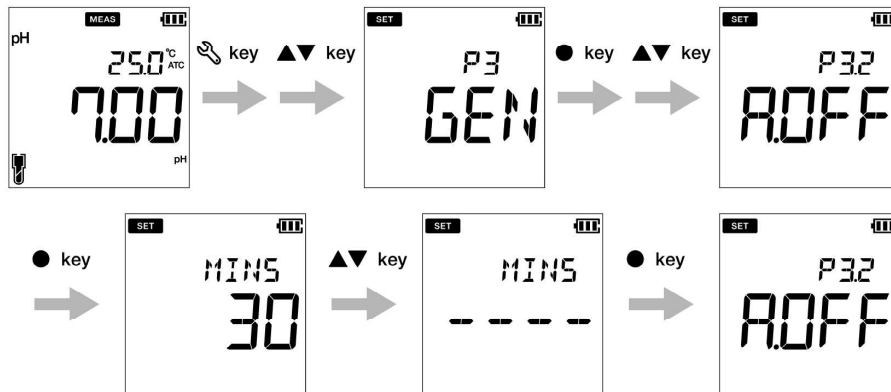





Note

The default shut off time is 30 minutes. This can be adjusted from 1 minute to 30 minutes. If you set the display to ---- it indicates Auto Off is disabled. Meter will be on indefinitely till the user switches off the meter.









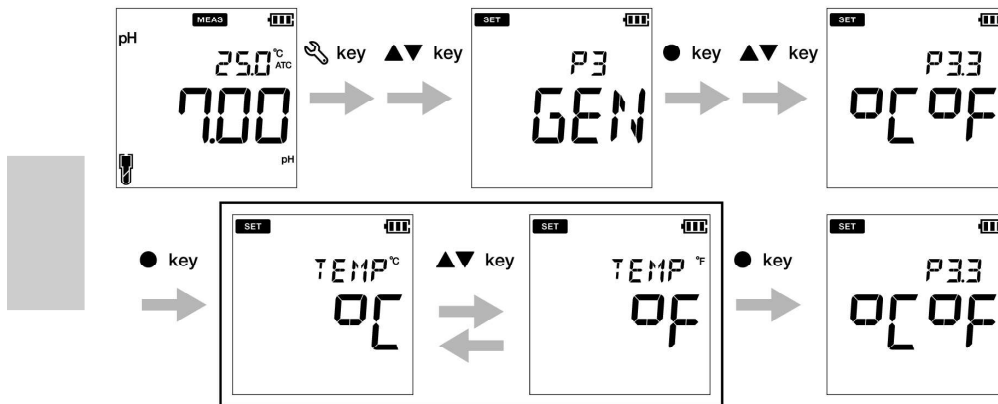



General set up

• P 3.3 Temperature unit setup

1. Press the  key, **P1 PH** screen appears.
2. Press the  key, **P2 DATA** screen appears.
3. Press the  key, **P3 GEN** screen appears.
4. Press the  key, **P3.1 STBL** screen appears.
5. Press the  key, **P3.2 A.OFF** screen appears.
6. Press the  key, **P3.3°C°F** screen appears.
7. Press the **ENT**  key, default temperature unit is °C.
8. Use the   keys to change the unit to °F.
9. Press the **ENT**  key, **P3.3°C°F** screen appears. This indicates completion of the end temperature unit selection.



• **P 3.4 Reset meter (factory default)**

1. Press the  key, **P1 PH** screen appears.
2. Press the  key, **P2 DATA** screen appears.
3. Press the  key, **P3 GEN** screen appears.
4. Press the **ENT**  key, **P3.1 STBL** screen appears.
5. Press the  key, **P3.2 A.OFF** screen appears.
6. Press the  key, **P3.3 °C°F** screen appears.
7. Press the  key, **P3.4 r.SET** screen appears.
8. Press the **ENT**  key, default meter re-setup is **NO**.
9. Use the   key to set it **YES**.
10. Press the  key. Meter displays **DONE** and automatically switches off.

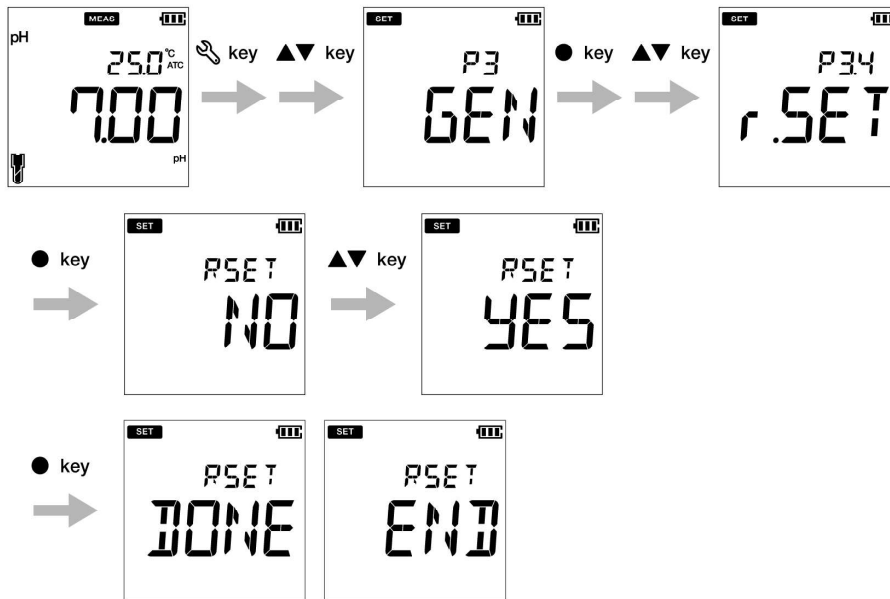

Clock set up

• P4 CLK setup

Real-time clock functionality is available only for OAKTON 200 series Handheld meters. Using P4 Clock setup function of the meter, you can set:

- Date
- Time

To set the clock function using OAKTON PH200 series Handheld meters, follow the procedure detailed below:

Prerequisites

Switch on the pH meter.

Note















Setup date and time is necessary before using the instrument for the first time or after replacing the batteries.

Set date and time data is captured correctly while saving data in the internal memory.

Tip

To return to the measurement mode, press the  key.





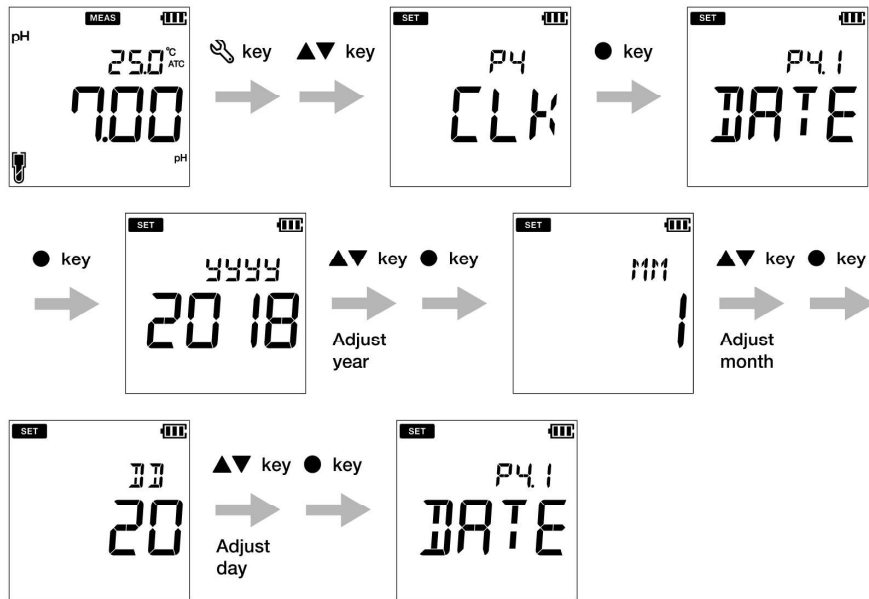







• P 4.1 Date setup

11. Press the  key, P1 PH screen appears.
12. Press the  key, P2 DATA screen appears.
13. Press the  key, P3 GEN screen appears.
14. Press the  key, P4 CLK screen appears.
15. Press the **ENT**  key, P4.1 DATE screen appears.
16. Press the **ENT**  key, default set year appears.
17. Use the   keys to adjust the year.
18. Press the **ENT**  key, default set month appears.
19. Use the   keys to adjust the month.
20. Press the **ENT**  key, default set day appears.
21. Use the   keys to adjust the day.
22. Press the **ENT**  key, P4.1 DATE screen appears. This indicates completion of the date setup.



Clock set up

• P 4.2 Time setup

1. Press the  key to switch to the setup mode, **P1 PH** screen appears.
2. Press the  key, **P2 DATA** screen appears.
3. Press the  key, **P3 GEN** screen appears.
4. Press the  key, **P4 CLK** screen appears.
5. Press the **ENT**  key, **P4.1 DATE** screen appears.
6. Press the  key, **P4.2 TIME** screen appears.
7. Press the **ENT**  key, default set hour appears.
8. Use the   keys to adjust the hour.
9. Press **ENT**  key, default set minute appears.
10. Use the   keys to adjust the minute.
11. Press **ENT**  key, **P4.2 TIME** screen appears. This indicates completion of the time setup.

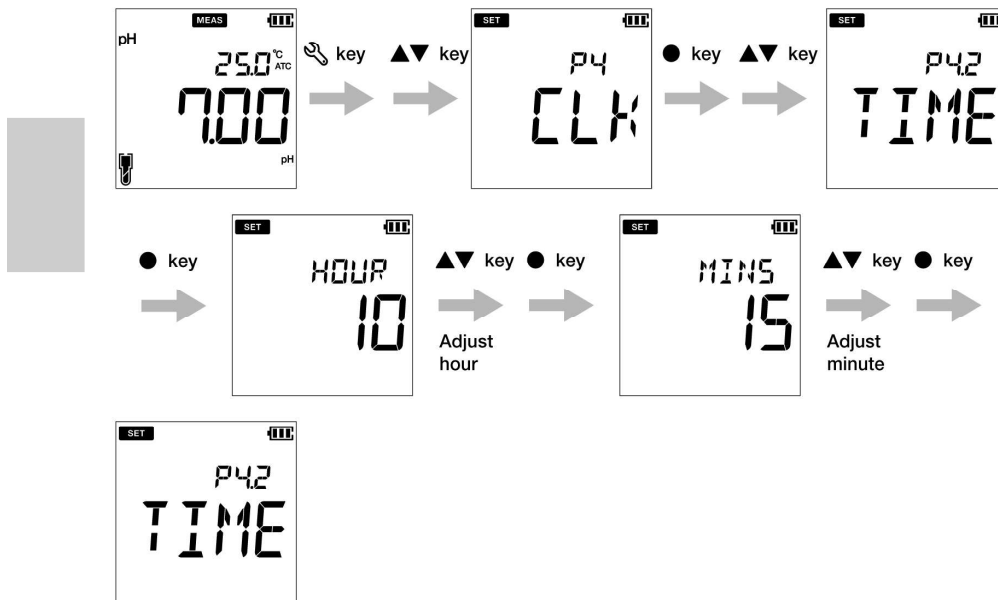

■ Maintenance and storage

This section describes maintenance of OAKTON PH200 series Handheld meters, pH and ORP electrodes used with the meter.

● Maintenance contract

Please contact your dealer for the product maintenance contract.

● Maintenance and storage of the instrument

● How to clean the instrument

If the instrument is dirty, wipe it gently with a soft dry cloth. If it is difficult to remove the dirt, wipe it gently with a cloth moistened with alcohol.

The instrument is made of solvent resistant materials but is not resistant to all chemicals. Do not dip the instrument in strong acid or alkali solution, or wipe it with such solutions.

Do not wipe the instrument with polishing powder or other abrasive compound.

● Environmental conditions for storage

Temperature: 0 °C to 45 °C

Humidity: under 80% relative humidity and free from condensation

● Avoid the following conditions:

Dusty place
Strong vibration
Direct sunlight
Corrosive gas environment
Close to an air-conditioner
Direct wind



Maintenance and storage

• Maintenance and storage of pH and ORP electrodes

This section describes an overview of the procedures for maintenance and storage of pH electrode.

• How to clean the electrodes

When the tip of an electrode (responsive membrane and liquid junction) becomes dirty, the response time may slow or an error may occur in the measurement results. To avoid such error, clean the electrode. For dirt that cannot be washed off by pure water (or deionized water), use the cleaning solution indicated below depending on the type of dirt. After cleaning, rinse the electrode with pure water (or deionized water).

However, for pH and ORP electrodes, different cleaning solutions should be used to clean different types of dirt.

For pH electrode

Type of dirt	Cleaning solution
General	Diluted neutral cleaning solution
Oil	Alcohol, or diluted neutral cleaning solution
Inorganic substance	1 mol/L HCl or electrode cleaning solution
Protein	Cleaning solution including protein-removing enzyme
Alkali	Dip in 1 mol/L HCl or electrode cleaning solution for 1h to 2 h

For ORP electrode

Type of dirt	Cleaning solution
General	Diluted neutral cleaning solution (General dish washing liquid works reasonably well.)
Oil	
Inorganic substance	Immerse dilute nitric acid (1:1 nitric acid)

• **Daily storage of the electrodes**

If the electrode becomes dry, the response will be slow. Store in a moist atmosphere. Follow the steps below to properly store the electrode:

12. Wash the electrode well with pure water (or deionized water) to remove sample completely, and close the internal solution filler port.
13. Wash the inside of the protective cap with pure water (or deionized water), then add enough pure water (or deionized water) to soak the sponge.
14. Attach the protective cap.

Note



When the electrode will not be used for a long period, store it by following the electrode storage procedure detailed above.

■ Error messages and trouble shooting

● Error message

This section describes the causes of typical errors and the actions to be taken to resolve respective errors.

If ERR is displayed while you are using the instrument, check the error, its cause and action to be taken in the error list below:

Meter display	ERR description	Cause of error and How to solve the problem
BATT LOW	Low battery	Battery power is low. Please replace with new batteries.
OFFS ERR	Offset voltage error	Electrode is dirty or reference junction is clogged. Clean the electrode.
SLPE ERR	Slope error	Electrode sensitivity is low. Please clean and recalibrate with fresh standard solution. If the problem persists, replace the electrode with new one.
BUFF ERR	Can not auto recognize standard solution	The instrument cannot identify the standard solution. Check the calibration solution and use fresh one if required.
	Calibration interval alarm error	Exceeds the calibration interval setup. Calibrate the meter.
MEM FULL	Memory data full	The number of the data saved has exceeded the specified number of items. Print or transfer the data. Or, clear stored data.
	If user selects the enter key before stable in calibration mode	● key is pressed before the calibration value has stabilized. Wait for the value to be stable and then press the ● key.

● **Trouble shooting**

This section describes causes and actions to take for problems that customers frequently ask.

The indicated value fluctuates

< **Problem with the electrode** >

Cause	How to solve problem
The electrode is dirty.	Clean the electrode.
The electrode is broken.	Replace the electrode.
The level of reference electrolyte gel.	Replace the electrode.

< **Problem with the instrument** >

Cause	How to solve problem
There is a motor or other device causing electrical interference.	Measure at a place where no influence from induction is given. Ground all AC-powered equipment.
The electrode is not connected correctly.	Connect the electrode properly.

< **Problem with the sample** >

Cause	How to solve problem
Electrode is not immersed enough to cover liquid junction.	The electrode must be immersed up to the liquid junction. As a guide, immerse to at least 3 cm from the tip of the electrode.
The stability of electrode is affected by the sample solution.	It is important to select an electrode that is appropriate for the sample. Consult your dealer. To confirm an electrode that is appropriate for the sample, check the pH electrode selection guide in our catalogue, or refer to our website.

Error messages and trouble shooting

The response is slow

Cause	How to solve problem
The electrode is dirty.	Clean the electrode.
The electrode is broken.	Replace the electrode.
The response of electrode is affected by the sample solution.	It is important to select an electrode that is appropriate for the sample. Consult your dealer. To confirm an electrode that is appropriate for the sample, check the pH electrode selection guide in our catalogue, or refer to our website.

The indicated value does not change

The measured value is out of the measurement range

When the measured value is below the display range, Ur appears. When the measured value is over the display range, Or appears.

Cause	How to solve problem
Sample is out of the measurement range.	Use a sample within the measurement range.
Electrode is not immersed enough to cover liquid junction.	The electrode must be immersed up to the liquid junction. As a guide, immerse to at least 3 cm from the tip of the electrode.
The electrode cable is broken.	Replace the electrode.
Calibration is not performed or performed incorrectly.	Perform calibration correctly.
Instrument defect	Check as explained below.

• **How to check for instrument defect**

Short the metal part of the outer tube to the center pin of the electrode connector of the corresponding channel of the instrument. If Ur or Or appears in this condition, consult your dealer.

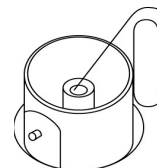

Repeatability of the measured value is poor.

Cause	How to solve problem
Effect of the sample solution.	Repeatability becomes poor when the pH of the sample changes over time.
The electrode is dirty.	Clean the electrode.
The electrode is broken.	Replace the electrode.
The internal solution of the electrode is partially depleted or contaminated.	Replace the electrode.

Nothing appears when the power is turned ON

Cause	How to solve problem
Power is not supplied.	Insert batteries.
Battery polarity (+, -) is reversed.	Insert the batteries with the polarity (+, -) correctly oriented.
Battery life is low.	Replace the batteries.
Instrument defect.	Consult your dealer.

Swelling of keypad

Cause	How to solve problem
Using the instrument at high elevation or other location where the air pressure is different from sea level.	To eliminate the pressure difference between the inside and outside of the instrument, briefly open and then close the serial connector and battery cover. After opening, correctly close the cover to maintain dust and water proofing.
Instrument defect	Consult your dealer.

Part of the display is missing

Cause	How to solve problem
Instrument defect.	Check the display by switching ON the instrument when all the LCD segments are lit.

■ **Appendix**

● **Appendix 1**

This section describes technical information and option for OAKTON PH200 series Handheld meters.

pH calibration can be performed according to several buffer standards. The most common standard is the US buffer standard. The default setup for the OAKTON PH200 series Handheld meters is US buffer standard. Alternative standards that can be chosen with the OAKTON 200 meter are NIST and DIN.

The pH buffers are temperature dependent i.e. the pH value changes with change in temperature. The OAKTON PH200 is intelligent to detect the temperature and pH value associated with buffer when calibration is performed. The meter remembers all the temperature vs. pH value for all the standards.

The pH vs. temperature values for the various standards are listed below:

< USA >

Temp. (°C)	pH 1.68	pH 4.01	pH 7.00	pH 10.01	pH 12.46
0	1.67	4.01	7.12	10.32	
5	1.67	4.01	7.09	10.25	13.25
10	1.67	4.00	7.06	10.18	13.03
15	1.67	4.00	7.04	10.12	
20	1.68	4.00	7.02	10.06	12.64
25	1.68	4.01	7.000	10.01	12.46
30	1.69	4.01	6.98	9.97	12.29
35	1.69	4.02	6.98	9.93	
40	1.70	4.03	6.97	9.89	11.99
45	1.70	4.04	6.97	9.86	
50	1.71	4.06	6.97	9.83	11.73
55	1.72	4.08	6.97	9.81	

< NIST >

Temp. (°C)	pH 1.68	pH 4.01	pH 6.86	pH 9.18	pH 12.46
0	1.67	4.00	6.98	9.46	
5	1.67	4.00	6.95	9.39	13.25
10	1.67	4.00	6.92	9.33	13.03
15	1.67	4.00	6.90	9.27	
20	1.68	4.00	6.88	9.22	12.64
25	1.68	4.01	6.86	9.18	12.46
30	1.69	4.01	6.85	9.14	12.29
35	1.69	4.02	6.84	9.10	
40	1.70	4.03	6.84	9.04	11.99
45	1.70	4.04	6.83	9.04	
50	1.71	4.06	6.83	9.01	11.73
55	1.72	4.08	6.83	8.99	

< DIN >

Temp. (°C)	pH 1.09	pH 3.06	pH 4.65	pH 6.79	pH 9.23	pH 12.75
0	1.08	3.10	4.67	6.89	9.48	13.37
5	1.09	3.10	4.66	6.87	9.43	13.37
10	1.09	3.10	4.66	6.84	9.37	13.37
15	1.09	3.08	4.65	6.82	9.32	13.17
20	1.09	3.07	4.65	6.80	9.27	12.96
25	1.09	3.06	4.65	6.79	9.23	12.75
30	1.10	3.05	4.65	6.78	9.18	12.61
35	1.10	3.04	4.65	6.77	9.13	12.45
40	1.10	3.04	4.66	6.76	9.09	12.29
45	1.11	3.04	4.67	6.76	9.04	12.14
50	1.11	3.04	4.68	6.76	9.00	11.98
55	1.11	3.04	4.69	6.76	8.96	11.84

Note

Calibration is performed using Nernst's equation with the above values.

• **Appendix 2**

Printer format - Measurement

pH

Meter Model	: OAKTON PH260
Serial Number	: 123456789
SW Revision	: 1.00
Date	: 20 Aug 2018
Time	: 10:10:28
Mode	: pH
pH	: 7.00 pH
mV	: 0.0 mV
Temperature	: 25.0 C (MAN)
Electrode Status	: Excellent
User Name	:
Signature	:

mV

Meter Model	: OAKTON PH260
Serial Number	: 123456789
SW Revision	: 1.00
Date	: 20 Aug 2018
Time	: 10:10:28
Mode	: mV
mV	: 0.0 mV
Temperature	: 25.0 C (MAN)
User Name	:
Signature	:



Relative mV

Meter Model	: OAKTON PH260
Serial Number	: 123456789
SW Revision	: 1.00
Date	: 20 Aug 2018
Time	: 10:10:28
Mode	: R. mV
R. mV	: 3.0 mV
Offset	: -3.0 mV
Temperature	: 25.0 C (MAN)
User Name	:
Signature	:

Printer format - Data log

Meter Model	: OAKTON PH260
Serial Number	: 123456789
SW Revision	: 1.00
User Name	:
Signature	:
Logged Data	
Location	: 2
Date	: 10 Aug 2018
Time	: 10:10:28
Mode	: pH
pH	: 7.00 pH
mV	: 0.0 mV
Temperature	: 25.0 C (MAN)
Electrode Status	: Excellent
Location	: 1
Date	: 10 Aug 2018
Time	: 10:09:28
Mode	: mV
mV	: 178.0 mV
Temperature	: 25.0 C (MAN)



Printout summary

Printer format - Calibration

PH

Meter Model	: OAKTON PH260
Serial Number	: 123456789
SW Revision	: 1.00
Date	: 20 Aug 2018
Time	: 10:10:28
Calibration data	
Cal Date	: 20 Jun 2018
Cal Time	: 10:10:10
Cal Points	: 4.01, 7.00, 10.01
Offset	: 0.0 mV
Avg Slope	: 98.2 %
Cal Temp.	: 25.0 C (ATC)
Electrode Status	: Excellent
User Name	:
Signature	:



• **Appendix 3**

Model	PH250	PH260
	pH/ORP/Temp (°C/°F)	
pH Range	-2.00 to 16.00 pH	
Resolution	0.01 pH	
Accuracy	±0.01 pH	
Calibration Points	USA & NIST (Up to 5), DIN (Up to 6)	
pH Buffer Groups	USA, NIST, DIN	
ORP Range	±2000 mV	
Resolution	0.1 mV (< ±1000 mV), 1 mV (≥ ±1000mV)	
Accuracy	±0.3 mV (< ±1000 mV), 0.3% of reading (≥ ±1000mV)	
Calibration Option	Yes	
Temperature Range	-30.0 to 130.0 °C / -22.0 to 266.0 °F	
Resolution	0.1 °C / °F	
Accuracy	± 0.5 °C / ± 0.9 °F	
Calibration Option	Yes	Yes
Memory	500	1000
Auto Data Log	●	●
Real-time Clock	-	●
Date & Time Stamp	-	●
Auto Hold / Auto Stable / Real Time	●	●
Offset & Average Slope Display	●	●
Calibration Alarm (1 to 90 days)	●	●
Auto Shut-Off (1 to 30 mins.)	●	●
Electrode Status	●	●
Diagnostic Messages	●	●
Software Upgrade	●	●
PC Communication	-	●
Printer Communication	-	●
Meter Inputs	BNC, phono	
Display	Custom LCD with backlight	
Housing	IP67, shock & scratch resistant, non-slip	
Power Requirement	2 × AA batteries	
Battery Life	> 500 hours	
Dimensions	160 (L) × 80 (W) × 40.60 (H) mm	

Specifications

Weight	Approx. 260 g (with batteries) / 216 g (without batteries)
--------	---



