

# TX2000

## Intelligent pH/ORP Transmitter

Operation  
Manual

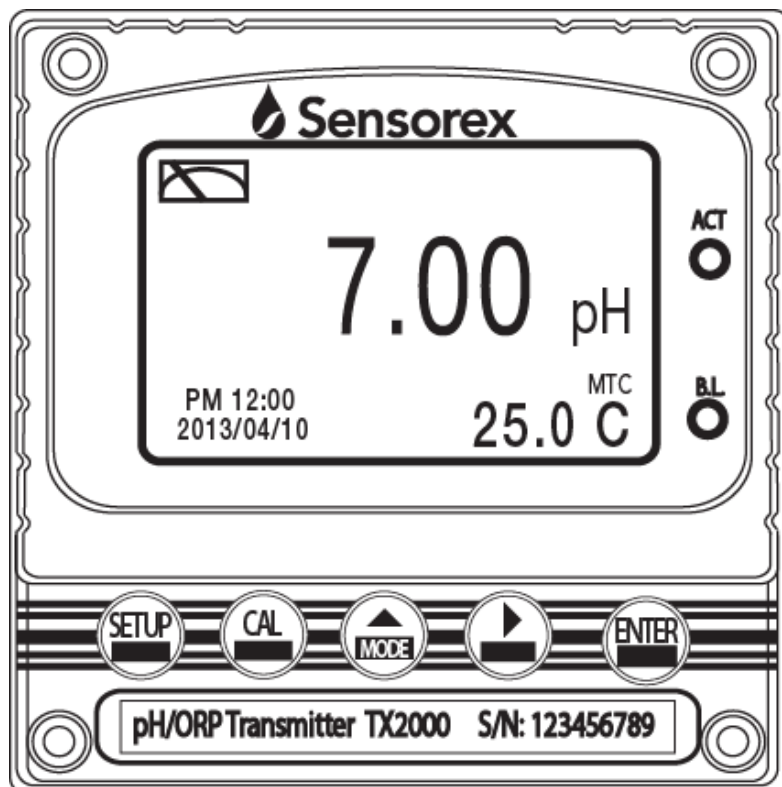

## Precautions for installation

Wrong wiring will lead to breakdown or electrical shock of the instrument, please read this operation manual clearly before installation.

- Make sure to remove AC power from the controller before wiring input, output connections, and remove it before opening the controller housing.
- The installation site of the controller should be good in ventilation and avoid direct sunshine.
- The material of signal cable should be special coaxial cable. Strongly recommend using our coaxial cable. Do not use normal wires instead.
- Avoid electrical surge when using power. Especially when using three-phase power, use ground wire correctly.
- The internal relay contact of the instruments is for alarm or control function. Due to safety, please must connect to external relay which can stand enough ampere to make sure the safety operation of the instruments. (Please refer to chapter 3.7 “Illustration of electrical connection” )



**Precautions for installation**

<b>Brief Instruction</b> .....	1
<b>1. Specifications</b> .....	4
<b>2. Assembly and installation</b>	
2.1 Transmitter installation.....	5
2.2 Illustration of panel mounting.....	5
2.3 Illustration of Wall mounting and pipe mounting.....	6
2.4 Assembly of electrode and housing.....	6
2.4.1 Cable set-up.....	6
2.5 Illustration and description of junction box.....	8
<b>3. Overview of Intelligent pH/ORP transmitter TX2000</b>	
3.1 Illustration of rear panel.....	10
3.2 Illustration of terminal function.....	10
3.3 Description of terminal function.....	11
3.6 Typical wirings.....	13
3.7 Illustration of electrical connection.....	14
<b>4. Configuration</b>	
4.1 Illustration of front panel.....	15
4.2 Keypad.....	15
4.3 LED indicators.....	15
4.4 Display.....	16
<b>5. Operation</b>	
5.1 Measurement mode.....	17
5.2 Set-up menu.....	17
5.3 Calibration menu.....	17
5.4 Reset	
5.4.1 Set-up reset.....	17
5.4.2 Calibration reset.....	17
<b>6. Settings</b>	
Block diagram of settings.....	18
6.1 Entry of set-up menu.....	19
6.2 Security code of settings(Code).....	20
6.3 Measurement parameters(Mode).....	21







6.4 Multi-point calibration(Multi-Cal).....	22
6.5 Temperature.....	23
6.6 Relay 1.....	24
6.7 Relay 2.....	25
6.8 Wash time(Clean).....	26
6.9 Analog output 1 (pH/ORP).....	27
6.10 Analog output 2 (temperature).....	28
6.11 Date/Time (Clock).....	29
6.12 Sample average of measurements (Digital filter).....	30
6.13 Backlight settings.....	31
6.14 Contrast settings.....	32
6.15 Automatically back to measurement mode(Return).....	33
<b>7. Calibration</b>	
Block diagram of Calibration.....	34
7.1 Entry of calibration menu.....	35
7.2 Security password of calibration.....	36
7.3 Automatically back to measurement mode(Return).....	37
7.4 pH calibration.....	38
7.4.1 TECH mode (Up to 3-point calibration).....	38
7.4.2 NIST mode (Up to 3-point calibration).....	38
7.4.3 Asymmetry mode (Up to 3-point calibration).....	38
7.4.4 Definition of calibration parameter.....	39
7.4.5 TECH, NIST buffer Calibration.....	40
7.4.6 Any Calibration.....	41
7.5 ORP calibration.....	42
<b>8. Error messages (Error code)</b> .....	43
<b>9. Maintenance</b> .....	44
<b>Appendix</b> .....	45

## Brief Instruction

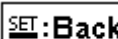

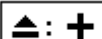

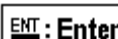

Description of set-up settings (see chapter 7 for details)







Press  and  simultaneously to see the overview of the set-up settings now. Then press  if you would like to modify set-up settings. Press keypad according to index of keypad on the screen.

### Index of keypad



keypad	Function	Description
		Back to upper layer
		Choose change to left page
		Increase digit
		Choose change to right page
		Decrease digit
		Confirm settings after modifications and then go through next step

### Selection of set-up items







keypad	Accordingly item	Description
Mode		Measurement mode, to choose pH or ORP measurement
Multi-Cal.		Multi-point calibration, to choose 1, 2, or 3 points calibration
Temperature		Temperature measurement and compensation, including MTC, PTC, NTC (3 types total). MTC---Manual temperature compensation, PTC/NTC--- auto temperature compensation
Relay 1		First relay setting, to choose action off or Hi/Lo alarm
Relay 2		Second relay setting, to choose action off or Hi/Lo alarm
Clean		Automatic wash time setting, to choose electrode cleaning equipment's ON and OFF duration
Analog 1		Current output according to pH or ORP setting range

Analog 2		Current output according for temperature
Clock		Clock setting <b>(When power is off, the input voltage time setting will return to the factory default +</b>
Back-light		Backlight setting, to set Auto/ON/OFF backlight, brightness, and sensitivity
Contrast		Contrast of screen setting
Digital Filter		Take every serial 1~60 measurements, average them continuously, and make it as the readings
Return		Return to the measurement mode
Code		Security code of set-up mode. The factory default is 1111, and a designated user can change the code.

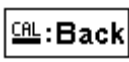

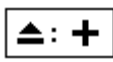
## Description of calibration settings (see chapter 8 for details)

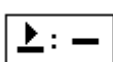
Press  and  simultaneously to see the last calibration information. Then press  to make a new calibration or modify setting of calibration. Press keypad according to index of keypad on the screen.

### Index of keypad:

keypad	Function	Description
		Back to upper layer
		Change to left page
		Increase digit
		Change to right page
		Decrease digit
		Confirm settings after modifications and then go through next step

### Selection of calibration items (up to three-point calibration)

keypad	Function	Description
Code		Security code of calibration mode. The factory default is 1100.
Return		Time interval setting of returning to the measurement mode
TECH	TECH	Use tech buffer as standard solution for calibration
NIST	NIST	Use NIST standard buffers(DIN 19266) as standard solution for calibration
Any	Any	Use any buffer solution by users' definition for calibration

### Note

Sensorex reserves the right to change the figure of icons and contents. The actual icons and contents please refer to the instruments.

## 1. Specifications

Model		<b>TX2000</b>
Measuring modes		pH / ORP / Temp.
Ranges	pH	-2.00~16.00 pH
	ORP	-1999~1999 mV
	Temp.	-30.0~130.0 °C
Resolutions	pH	0.01 pH
	ORP	1 mV
	Temp.	0.1 °C
Accuracy	pH	±0.01 pH ± 1 Digit
	ORP	±0.1% ± 1 Digit
	Temp.	±0.2°C± 1 Digit
Temperature Compensation		NTC30K/ PT 1000 auto temperature compensation Manual adjustment temperature compensation
Calibration mode		Tech. 、 NIST. 、 Asymmetry mode, up to three point calibration
Ambient Temp.		0~50°C
Storage Temp.		-20~70°C
Input Impedance		> 10 <sup>12</sup> Ω
Display		Large LCD display with environment light sensor auto/manual illumination function
Analog output 1		Isolated DC 0/4~20mA corresponding to main measurement, max. load 500Ω
Analog output 2		Isolated DC 0/4~20mA corresponding to Temp., max. load 500Ω
Settings	Contact	RELAY contact , 240VAC 0.5A Max.(recommend)
	Activate	Two sets of individual HIGH or LOW programmable control
Wash		RELAY contact: ON 0~99min. 59sec. / OFF 0~999hr 59min.
Voltage Output		DC±12V , 1W max.
Certification		IP65
Power Supply		100V~240VAC±10% , 4W max. , 50/60Hz
Installation		Wall or Pipe or Panel Mounting
Dimensions		96m × 96mm × 132mm (H×W×D)
Cut off Dimensions		93 mm × 93 mm (H×W)
Weight		0.5Kg

Note: The specifications are subject to change without notice.



## 2. Assembly and installation

**2.1 Transmitter installation:** This Transmitter can be installed through panel mounting, wall mounting and pipe mounting.

**Panel mounting:** First, prepare a square hole of 93 x 93mm on the panel box, and then insert the controller directly into the panel box. Insert the mounting bracket from the rear, until it is locked into the pickup groove.

### 2.2 Illustration of panel mounting:

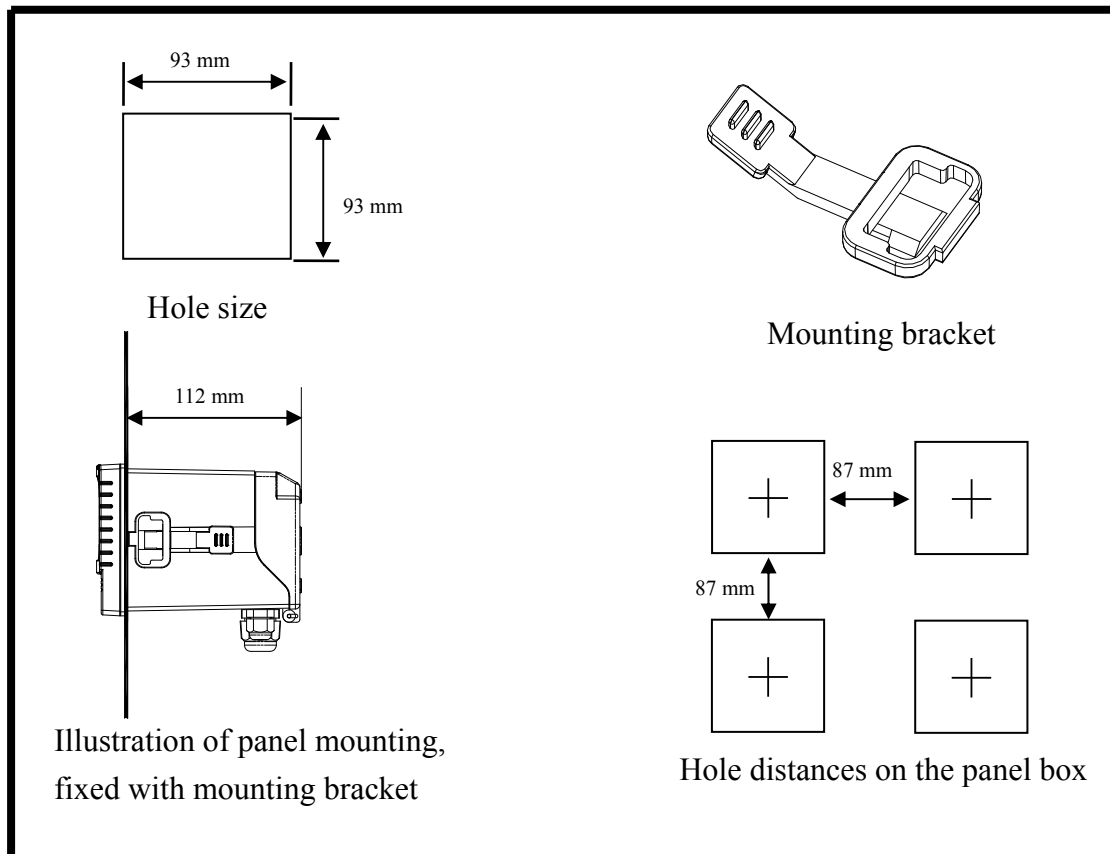

## 2.3 Illustration of Wall mounting and pipe mounting

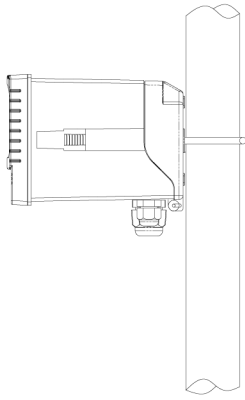

Installation of pipe mounting  
Fixed with U-shaped pipe clip. The distance between screw holes is 60mm

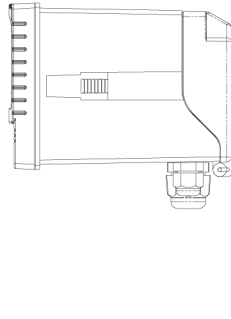

Installation of wall mounting  
Fixed with 4 x M4 screws

## 2.4 Assembly of electrode and housing

### 2.4.1 Cable set-up:

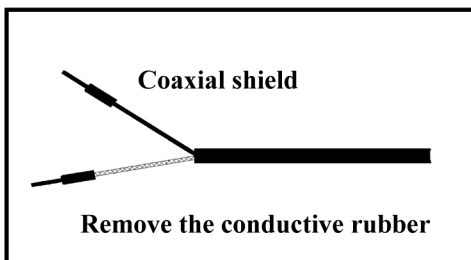

Set-up diagram of coaxial cable:

See the correct set-up method on the left:

**Note: The black conductive rubber covering on the coaxial inner should be removed for use.**

- Make sure to remove the conductive rubber or aluminum-foil paper between the electrode signal wire and the coaxial shield.
- Extend the cable to the controller without any joint except specific junction box. Connect the coaxial inner directly to the Glass contact on the back of controller and connect coaxial shield to Ref. contact.

**This page  
intentionally  
left blank**

**This page  
intentionally left  
blank**

**This page  
intentionally  
left blank**

### 3. Overview of pH transmitter TX2000

#### 3.1 Illustration of rear panel:

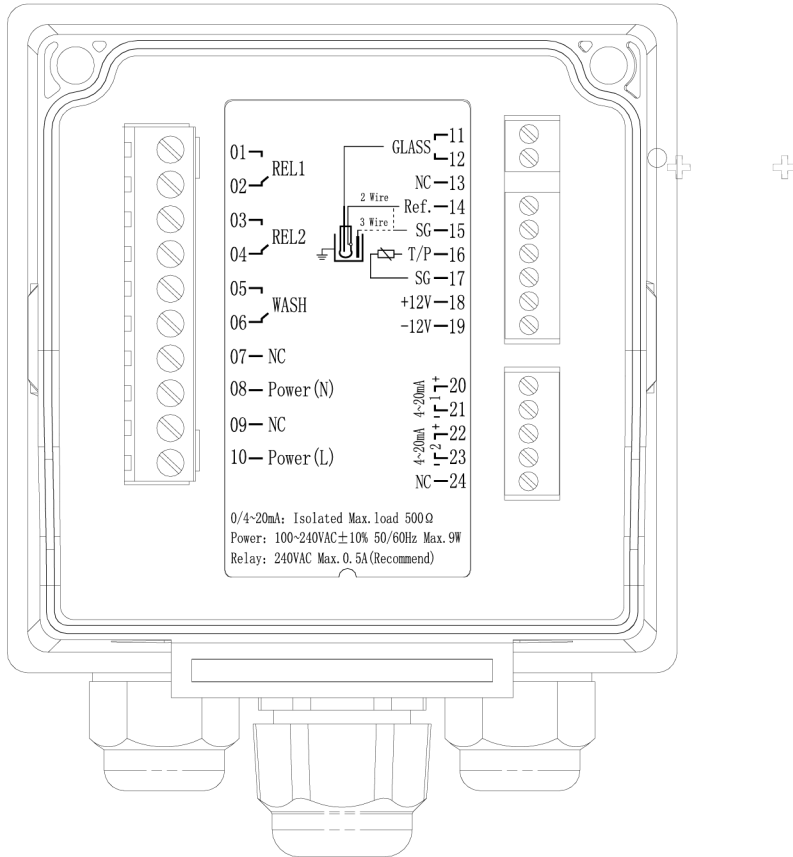

#### 3.2 Illustration of terminal function:

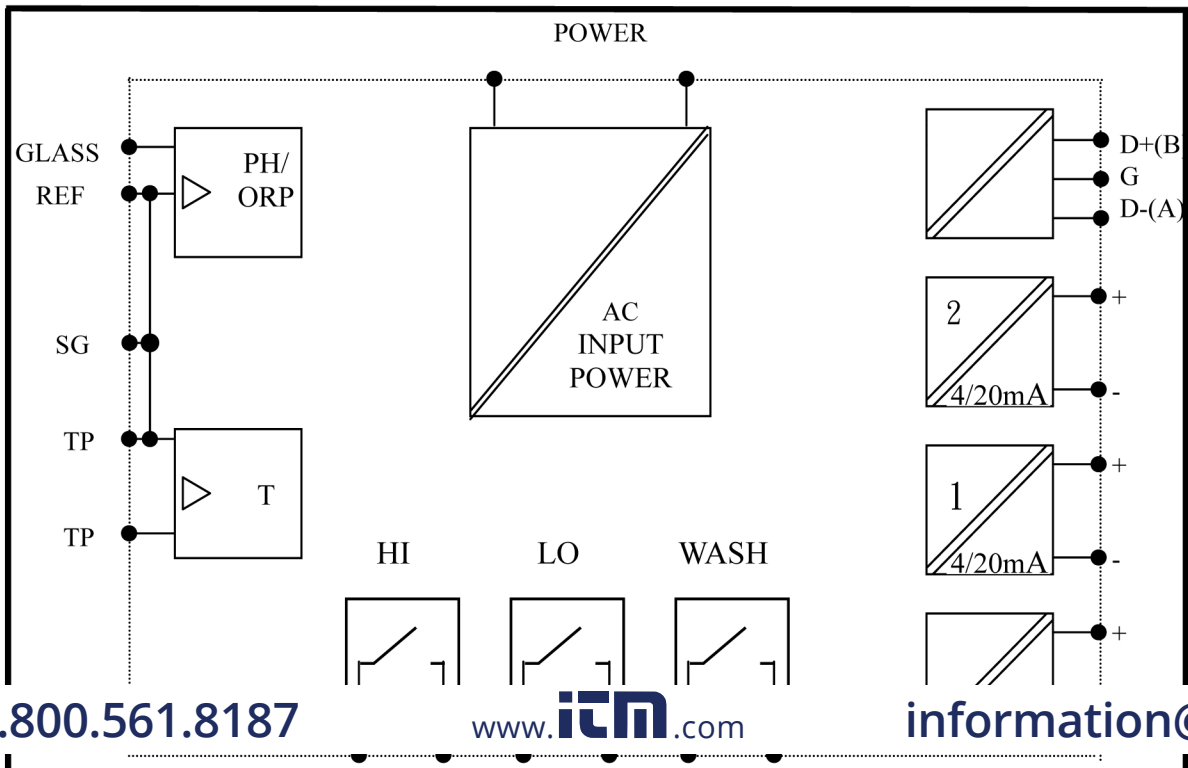

1.800.561.8187

www.itm.com

information@itm.com

### 3.3 Description of terminal function:

01	REL1	External relay terminal high control
02	REL2	External relay terminal low control
03	WASH	External wash relay terminal
04		
05		
06		
07	NC	None contact
08	100~240AC	Power supply terminal
09	NC	None contact
10	100~240AC	Power supply terminal
11	GLASS	Coaxial inner connecting pH/ORP
12		electrode signal wire
13	NC	None contact
14	REF	Coaxial shield connecting pH/ORP electrode signal wire
15	SG	The terminal connecting temperature probe, or used as $\pm 12V$ ground potential. <b>In two-wire distributing system, there should be a short circuit between this terminal and REF (a short circuit slice is attached when going out the factory)</b>
16	T/P	Connect the other end of temperature probe
17	SG	The other terminal connecting temperature probe, or used as $\pm 12V$ ground potential.
18	DC $\pm 12V$	Output terminal of direct current voltage $\pm 12V$
19		
20	4~20mA +terminal	Master measure current output terminal +, for external recorder or PLC control
21	4~20mA - terminal	Master measure current output terminal -, for external recorder or PLC control
22	4~20mA + terminal/ D+(B)	Temperature current output terminal +, for external recorder or PLC control (only applicable for TX2000); or RS-485 output D+(B) (only applicable for TX2000RS)
23	4~20mA - terminal G	Temperature current output terminal -, for external recorder or PLC control (only applicable for TX2000); or RS-485 output GND (only applicable for TX2000RS)
24	NC / D- (A)	NC or RS-485 output D-(A) (only applicable for TX2000RS) or RS-485 output D-(A) (only applicable for TX2000RS)

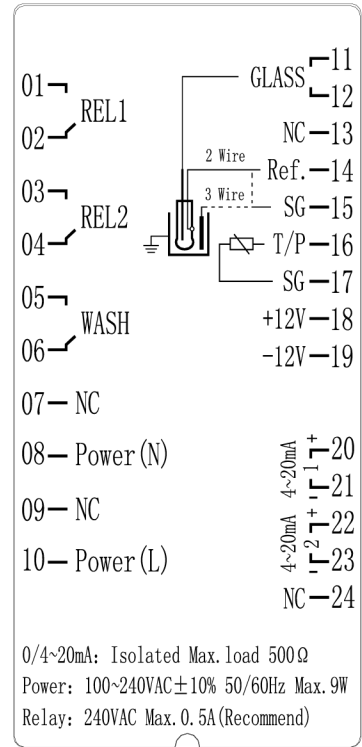

**This page  
intentionally left  
blank**



**This page  
intentionally left  
blank**

### 3.7 Illustration of electrical connection:

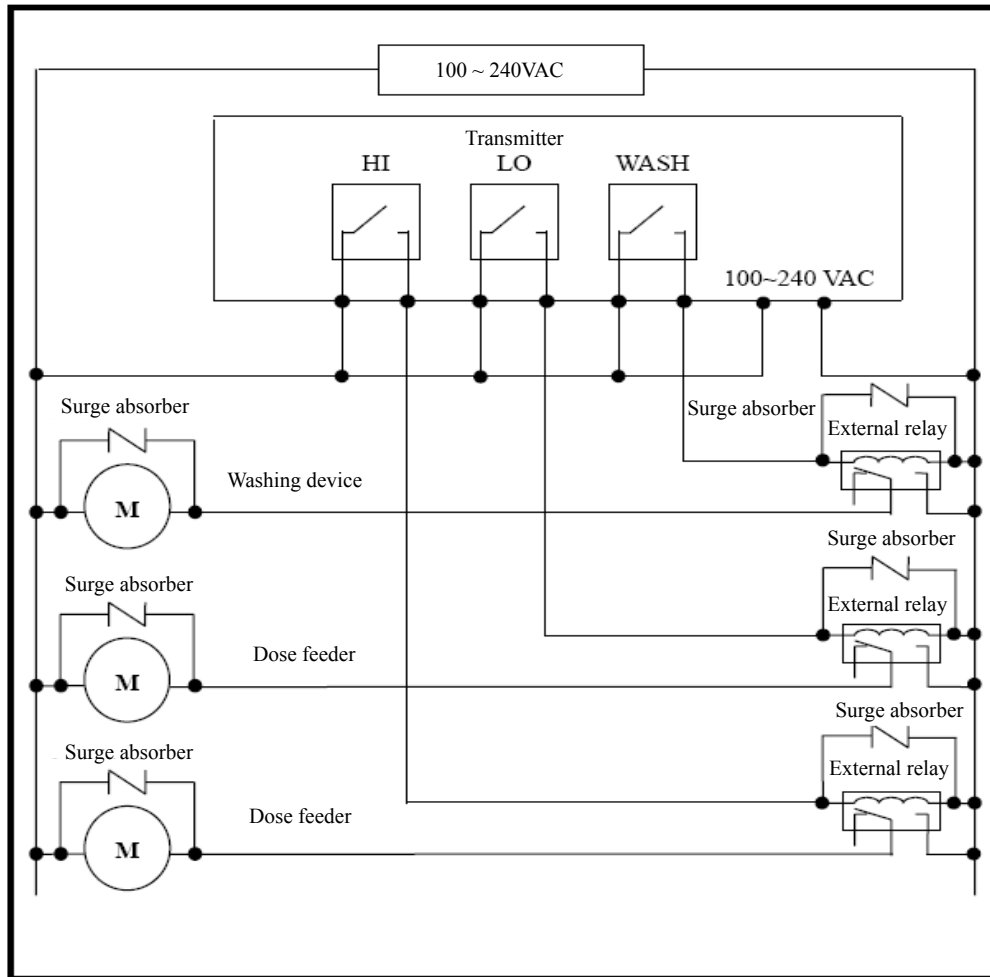



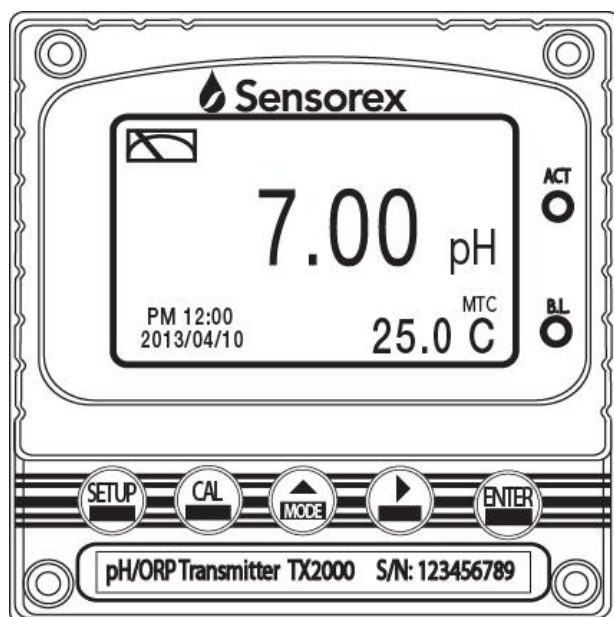

## 4. Configuration:

### 4.1 Illustration of front panel:



### 4.2 Keypad:

In order to prevent inappropriate operation by others, before the parameter setting and calibration, the operation applies multi-keys, and coding protection if necessary. Description of the key functions is in the following:

-  : In the parameter set-up mode, pressing this key allows you exit parameter set-up mode and return back to Measurement mode.
-  : In the Calibration mode, pressing this key allows you exit Calibration mode and return back to Measurement mode.
-  :
  1. In the parameter set-up mode and Calibration mode, press this key to select left change or to go to another page.
  2. When adjusting value, press this key to increase the value.
-  :
  1. In the parameter set-up mode and Calibration mode, pressing this key to select right change or to go to another page.
  2. When adjusting value, press this key to decrease the value.
-  : Key for confirmation; pressing this key is essential when modifying data value or selecting the parameter setting items in the window.



### 4.3 LED indicators:

**ACT** : Washing device operation indicator and controlling operation indicator (Relay 1 · Relay 2)

**B.L.** : Light sensor; in the automatic display backlit mode, the lamp will light or go out as the change of environmental brightness.

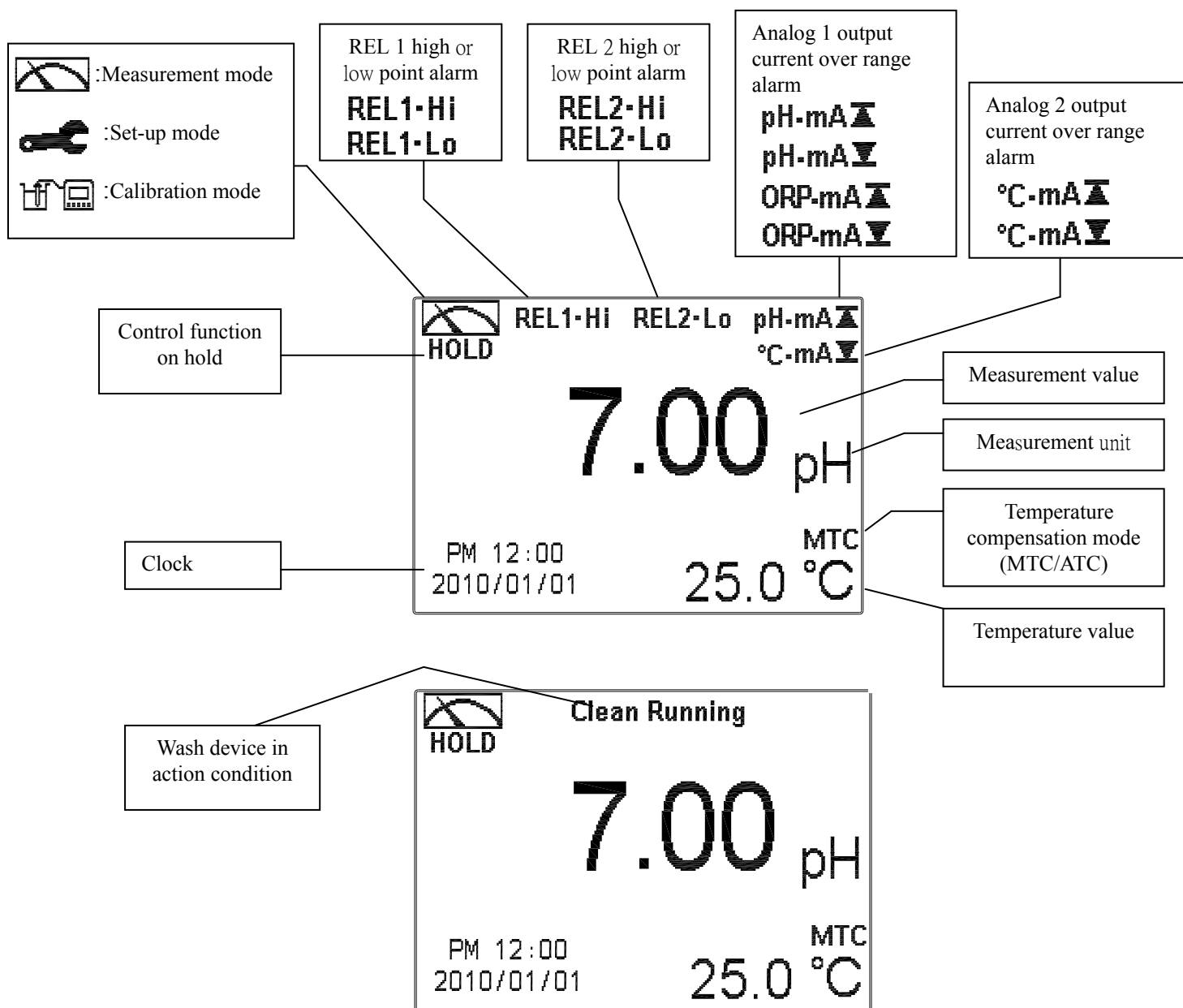
## 4.4 Display:





- Note: 1. When the wash device is turned on, the display shows and flashes the description, “Clean Running”. At the same time, the ACT indicator LED lights up, and the transmitter automatically turns off Relay 1 and Relay 2 function. After finishing cleaning, the Relay 1 and Relay 2 will automatically back to normal status.
2. When Relay 1 which is set in high setting point is in action, the display shows and flashes the description, “REL 1\_Hi”, and ACT indicator LED lights up. When Relay 1 which is set in low setting point is in action, the display shows and twinkles the description, “REL 1\_Lo”, and ACT indicator LED lights up.
3. When Relay 2 which is set in high setting point is in action, the display shows and flashes the description, “REL 2\_Hi”, and ACT indicator LED lights up. When Relay 2 which is set in low setting point is in action, the display shows and flashes the description, “REL 2\_Lo”, and ACT indicator LED lights up.
4. When under measurement mode, if the temperature compensation mode is set in MTC (Manual adjustment), press  or  to adjust the MTC temperature manual.

## 5. Operation



### 5.1 Measurement mode:

After all electrical connections are finished and tested, connect the instrument to the power supply and turn it on. The transmitter will automatically enter measurement mode with the factory default settings or the last settings from user.

### 5.2 Set-up menu:

Please refer to the set-up instructions in Chapter 6. Press  and  simultaneously to enter into set-up menu, and press  to go back to measurement mode.

### 5.3 Calibration menu:

Please refer to the calibration instructions in Chapter 7. Press  and  simultaneously to enter into calibration menu, and press  to go back to measurement mode.

### 5.4 Reset:

#### 5.4.1 Master reset:

Measurement mode: pH  
Multi-Cal : 2 points pre-setting  
Temperature compensation: MTC 25°C  
Relay 1 : High point alarm: AUTO, SP1= 10.00 pH, db1= 0.10 pH  
Relay 2 : Low point alarm: AUTO, SP2 =04.00 pH, db2= 0.10 pH  
Wash time: OFF  
Analog 1 current output (pH/ORP) : 4~20 mA , 2.00~12.00pH  
Analog 2 current output (Temp) : 4~20 mA , 0~100.0°C ( TX2000 only )  
Display backlit: Auto , Brightness= 0 , Sensitivity =0  
Code set-up: OFF  
Date & Time : 2010/1/1 00:00:00  
Contrast: 0  
Auto back: Auto, 3 minutes

#### 5.4.2 Calibration reset:

Asy : 0 mV  
Slope : -59.15 mV/pH @ 25.0°C  
Calibration type : TECH-No Cal  
Calibration value: No data  
Auto back: Auto, 3 minutes



Note: The factory default of calibration presetting is “No Cal”, and the calibration value is “None”. It means that the user has not calibrated the sensor with the transmitter yet. After finishing every calibration, the display shows the calibration mode and the calibration value. If the equipment has not been calibrated yet, the measurement takes pre-set Asy and Slope into calculation.

## 6. Settings

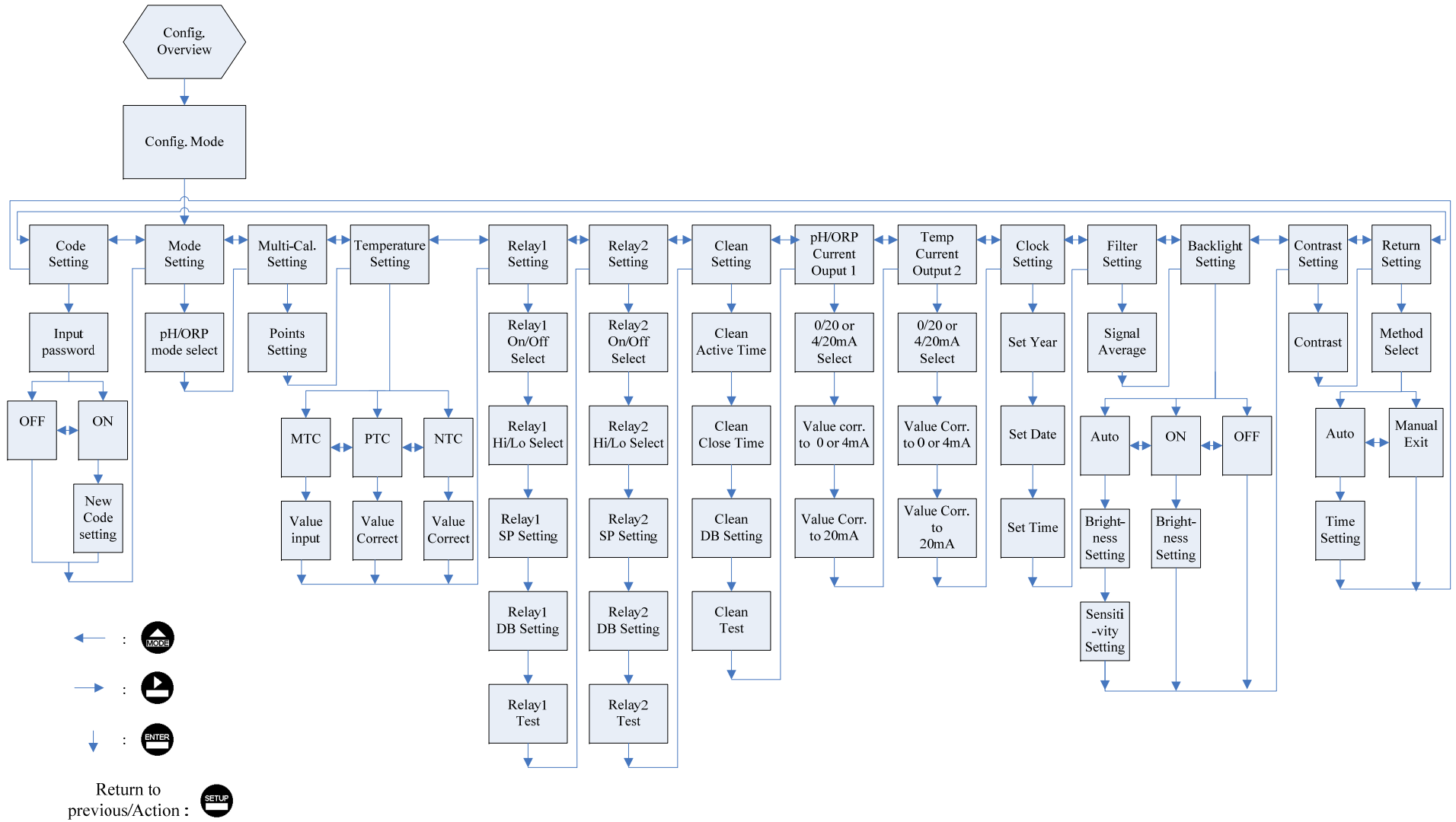
Block diagram of settings



## 6.1 Entry of set-up menu

In the measurement mode, pressing the two keys  and  simultaneously allows you enter the overview of current setting, and press  to enter the set-up mode to modify the setting if necessary.

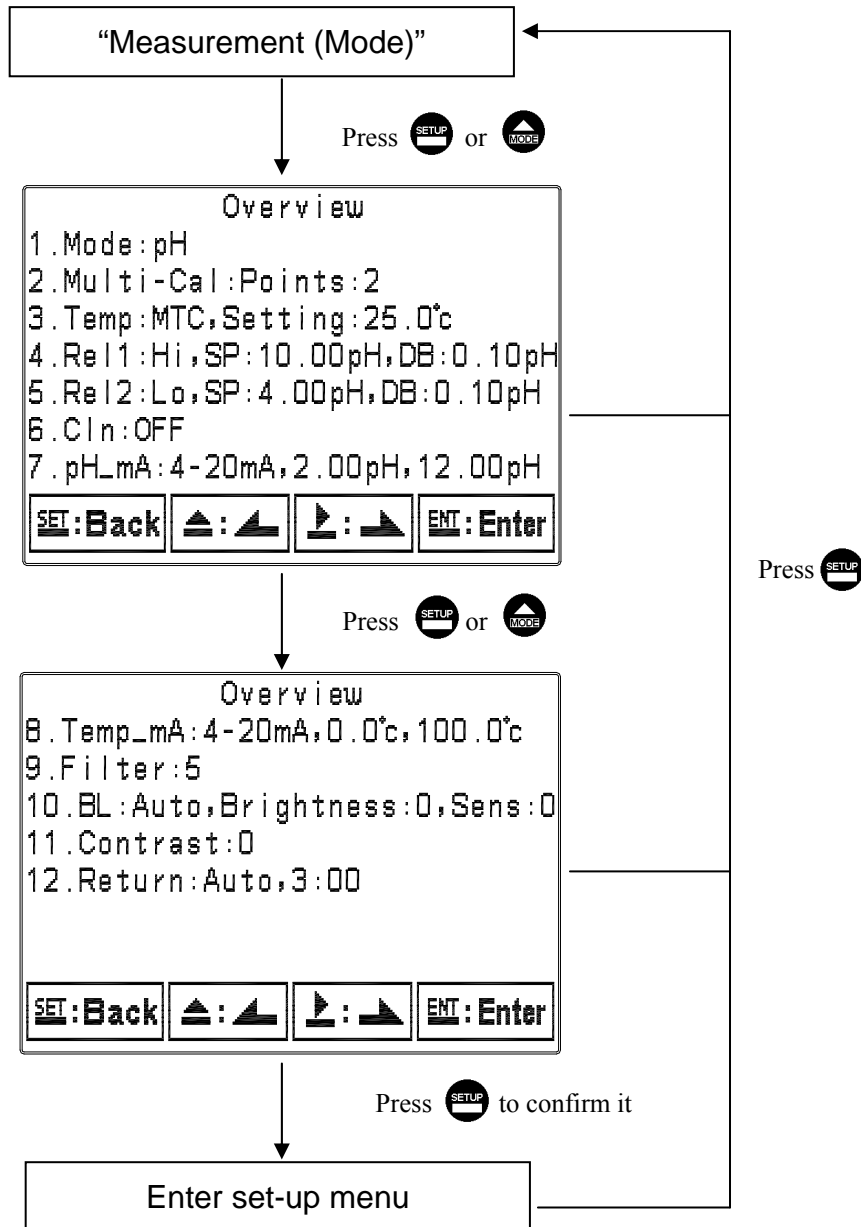

## 6.2 Security code of settings:

After entering set-up mode, select “code” item, press  to enter into code procedure. The preset code is 1111.

Note: The code of setting mode must be done prior to the code for calibration. That means that the code of setting mode can be used for the code of calibration mode.

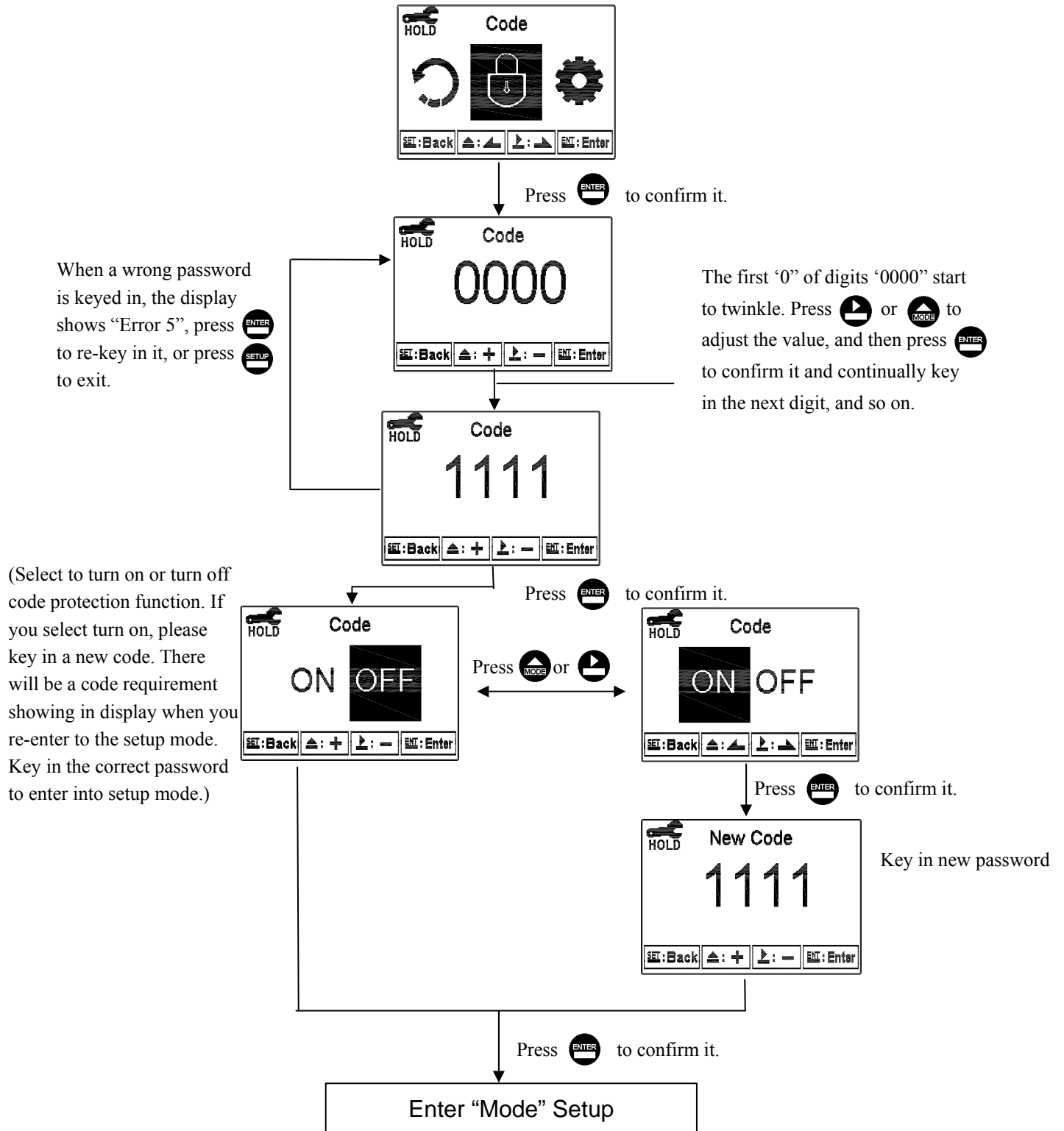



### 6.3 Mode

Enter setup of “Mode”. Select between “pH” or “ORP” measurement.

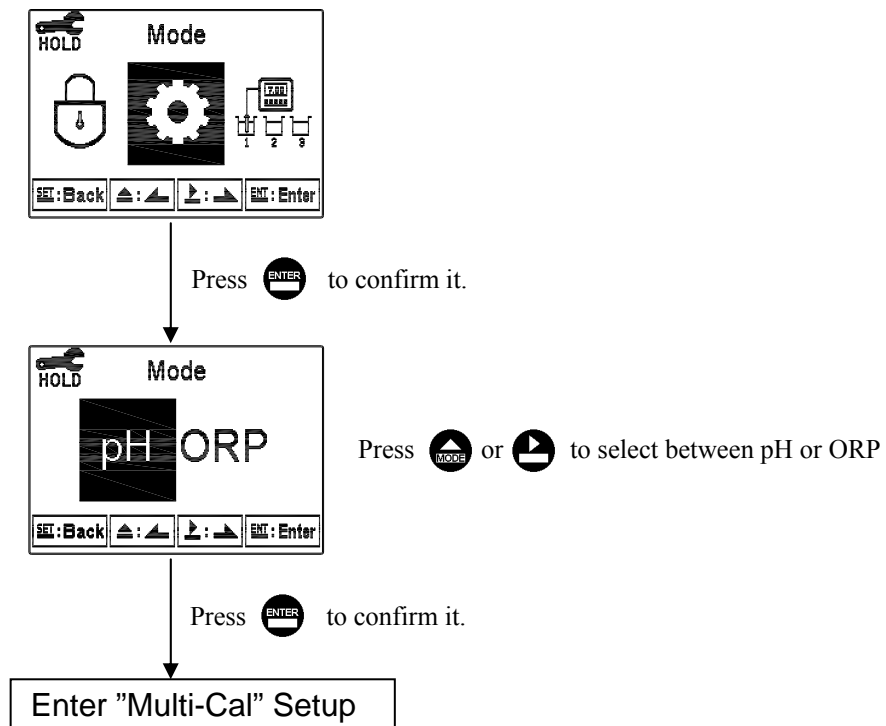

## 6.4 Multi-Cal

Enter setup of multi-points calibration to set the number of calibration points.

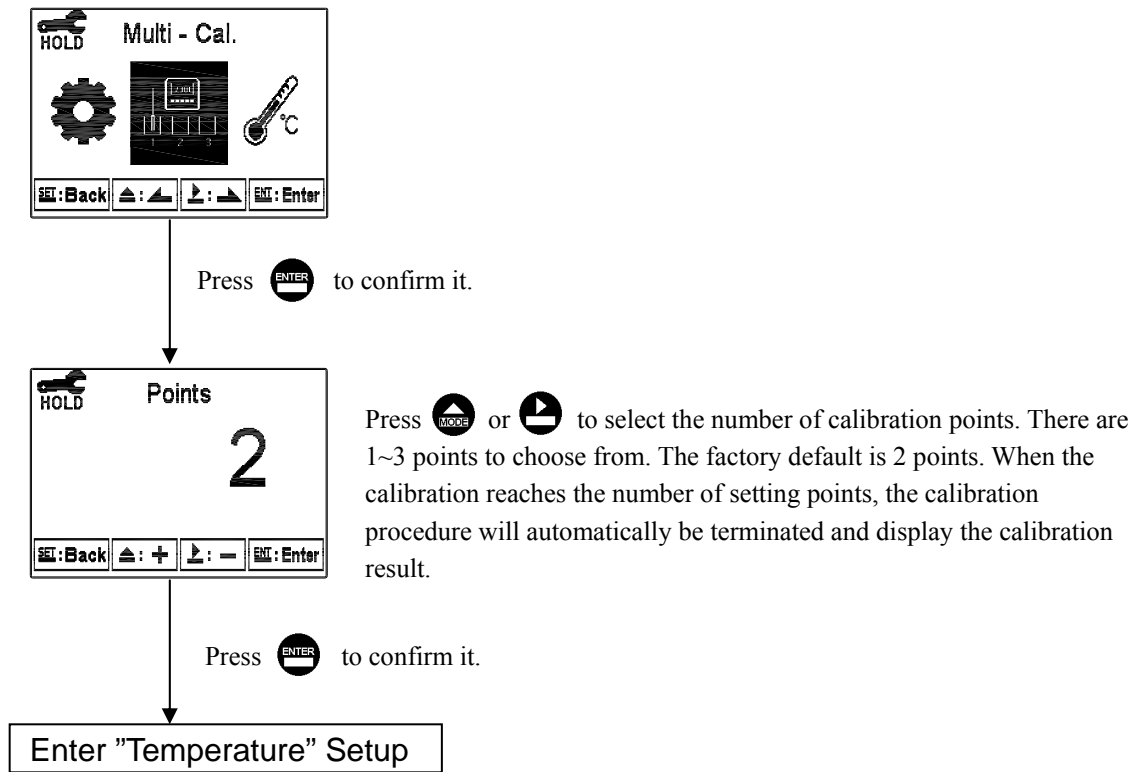

## 6.5 Temperature

Enter setup of “Temperature” to select temperature compensation mode. Select from NTC(NTC 30K), PTC(PT 1K) or MTC(Manual adjustment).

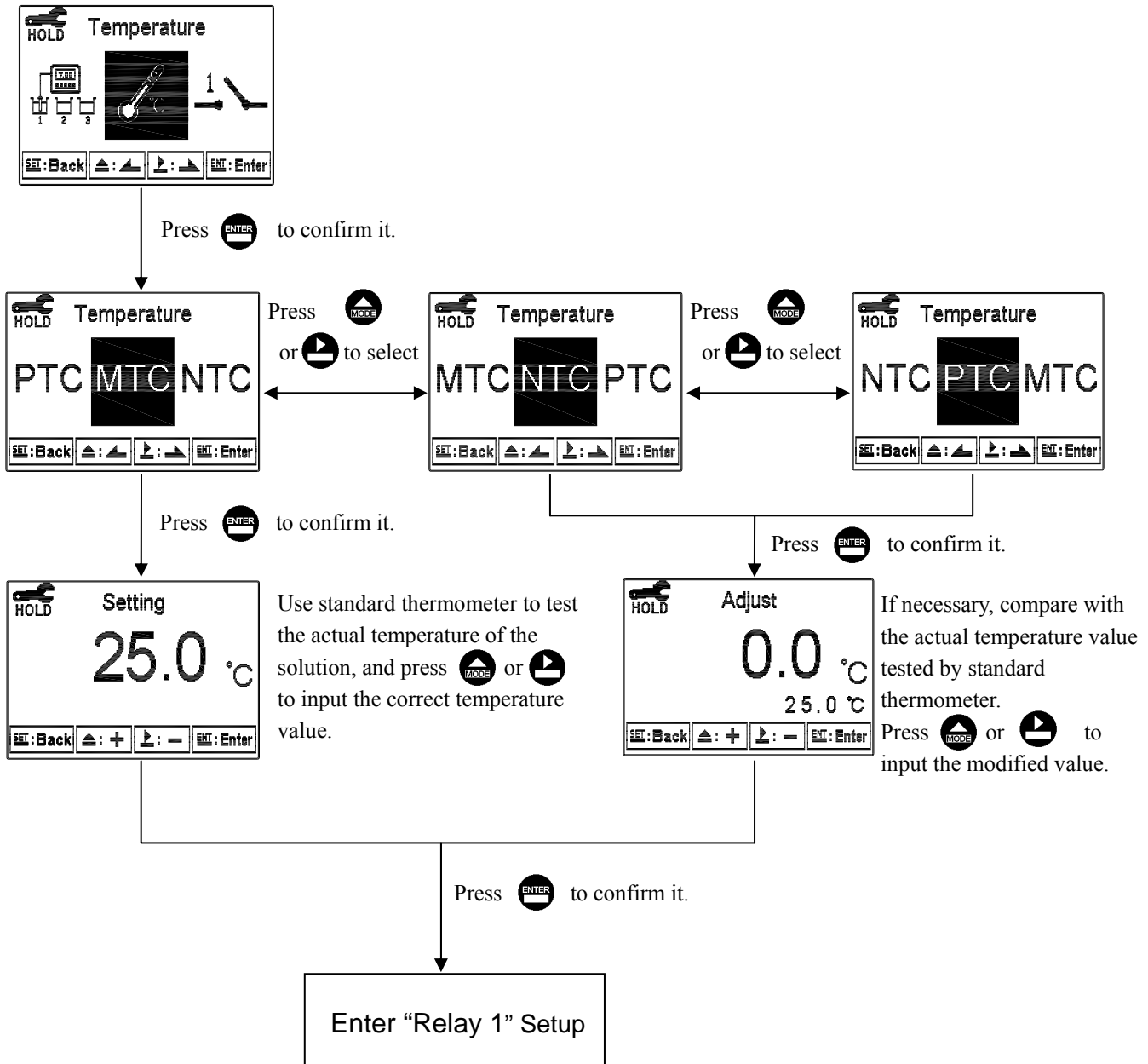

## 6.6 Relay 1

Enter setup of Relay 1. Select the item to turn on or turn of the relay 1 function. If you select to turn on the relay 1, then select for using relay 1 as “Hi set-point” alarm or “Low set-point” alarm. Set the value of set-point (SP) and dead-band (DB). The range for set-point is -2.00~16.00pH/-1999~1999mv; while the range for DB is 0.00~2.00pH /0~200mv.

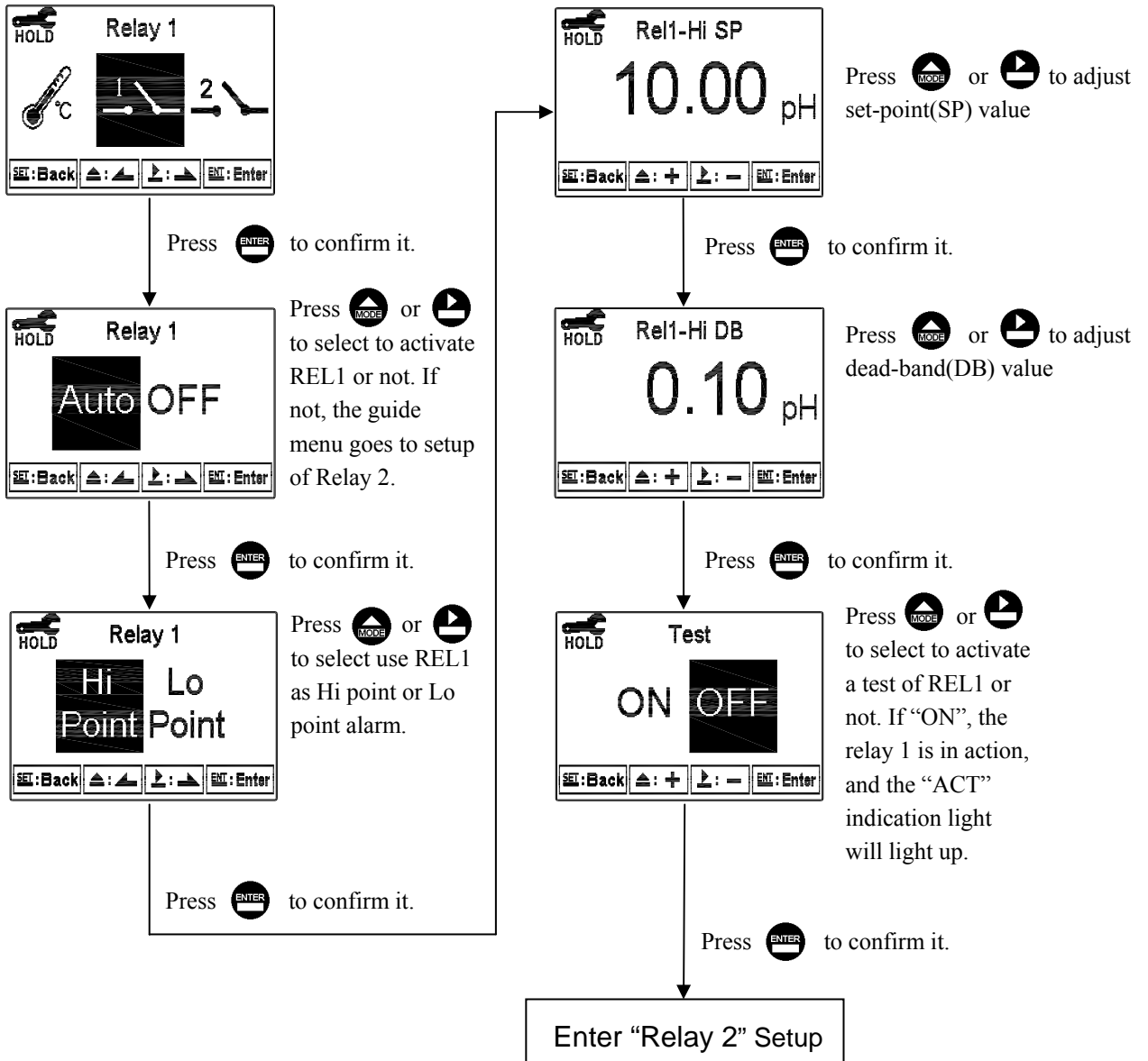

## 6.7 Relay 2

Enter setup of Relay 2. Select the item to turn on or turn of the relay 2 function. If you select to turn on the relay 2, then select for using relay 2 as “Hi set-point” alarm or “Low set-point” alarm. Set the value of set-point (SP) and dead-band (DB). The range for set-point is -2.00~16.00pH/-1999~1999mv; while the range for DB is 0.00~2.00pH /0~200mv.

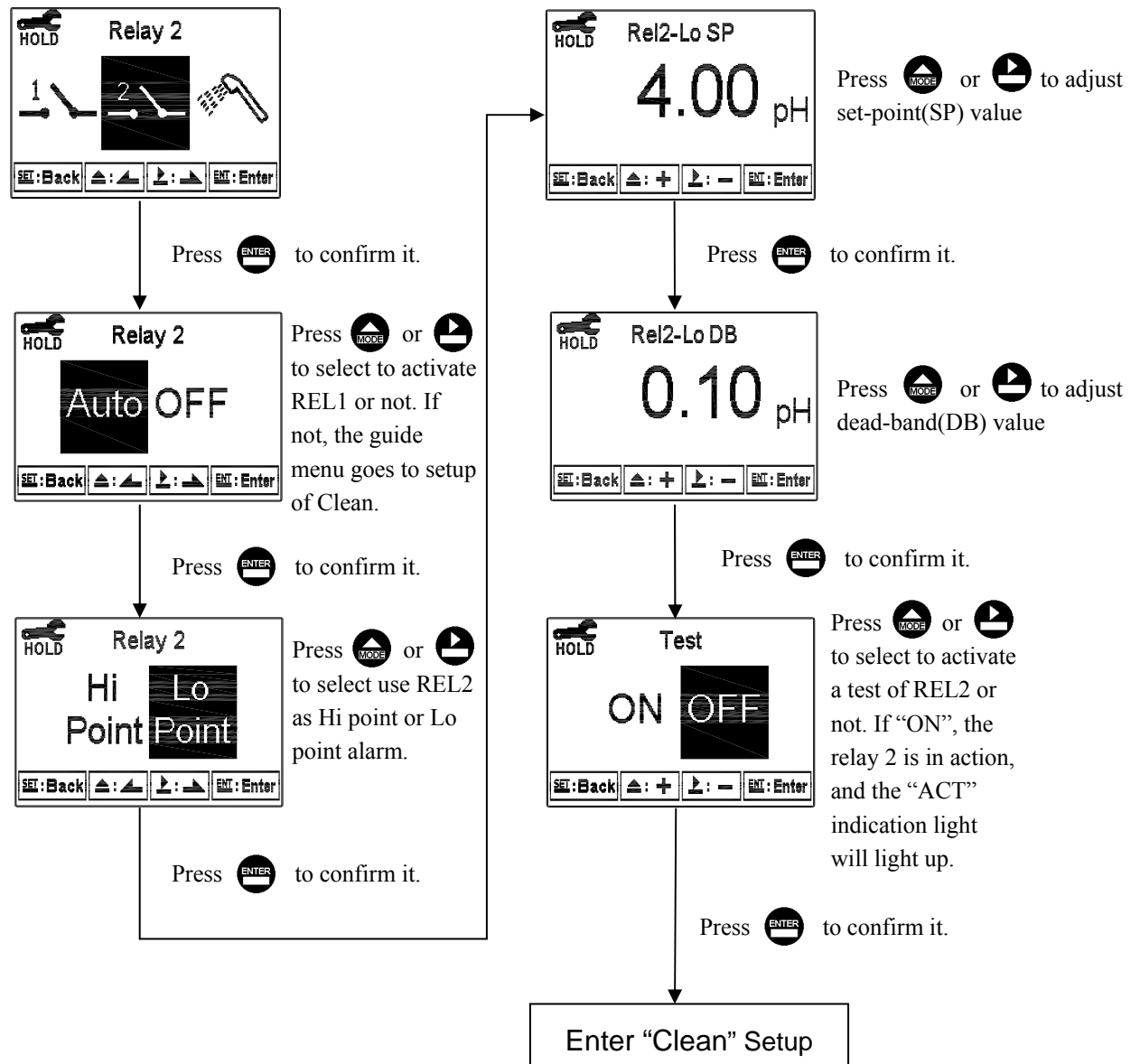

## 6.8 Clean

Enter setup of “Clean” function. Select the icon to turn on or turn off the clean function.

If you select “Auto” turning on, and set the timer of the clean function including automatically turning on time and turning off time, and set the bead-band value(DB).

Note: When the clean function is turned on, if any value is set to be 0, the instrument will automatically turn off this function.

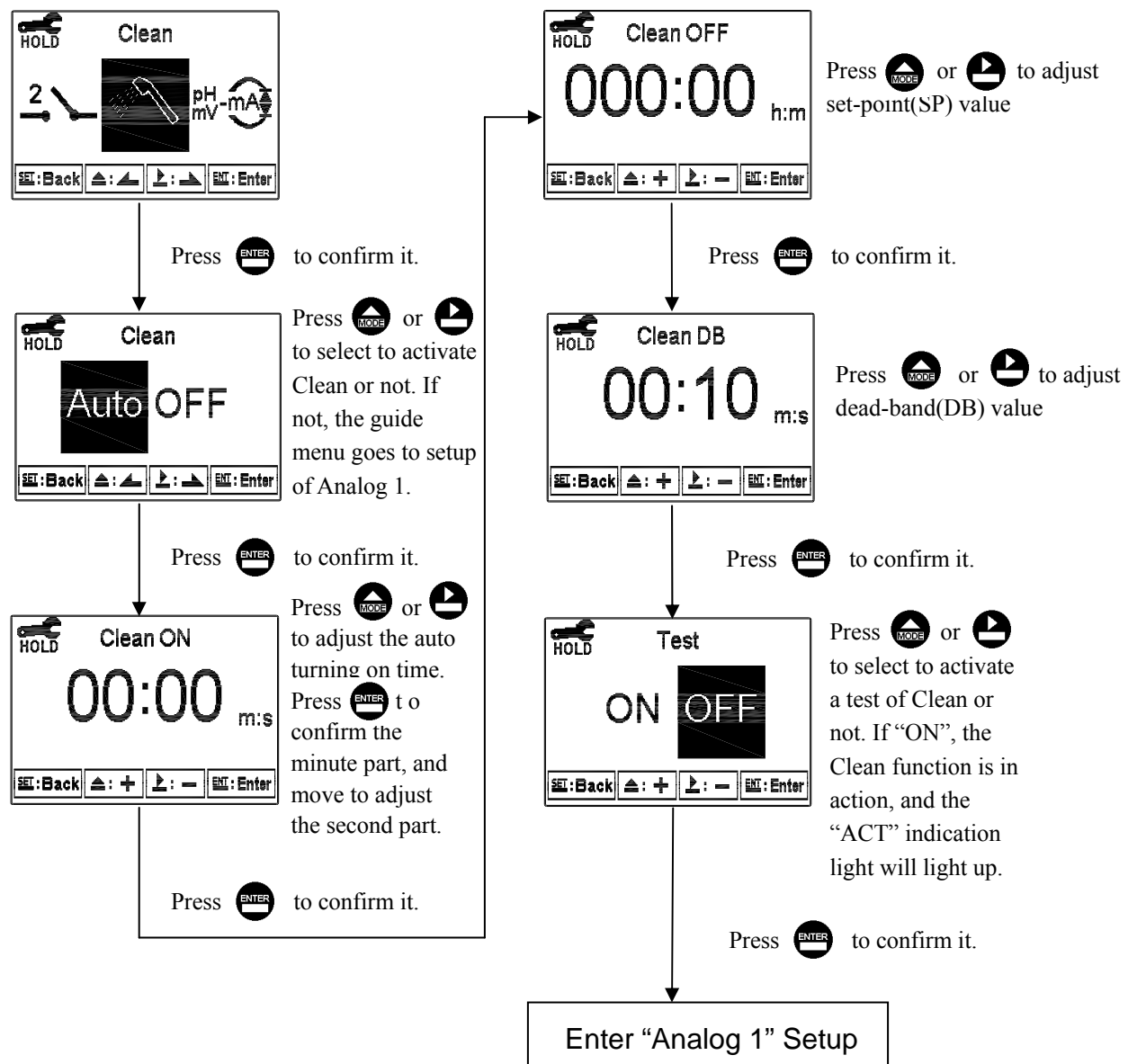

## 6.9 Analog output 1 (pH/ORP):

Enter setup of Analog 1. Select 0~20mA or 4~20mA current output. Set the related value to the range of pH/ORP measurement. If the range or the pH/ORP measurement is smaller, the resolution of current output is higher.

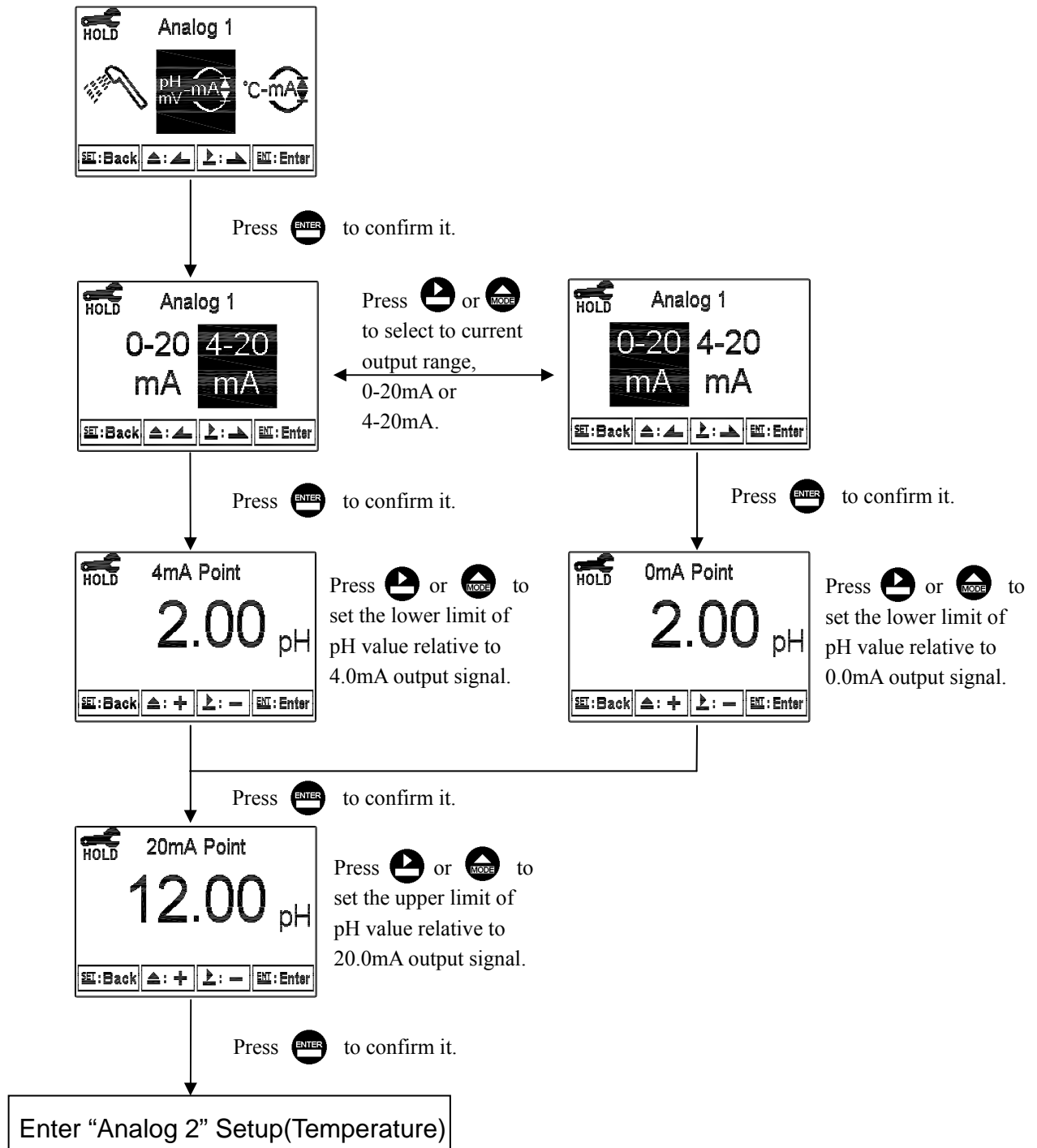

## 6.10 Analog output 2 (Temperature):

Enter setup of Analog 2. Select 0~20mA or 4~20mA current output. Set the related value to the range of temperature measurement. If the range or the temperature measurement is smaller, the resolution of current output is higher.

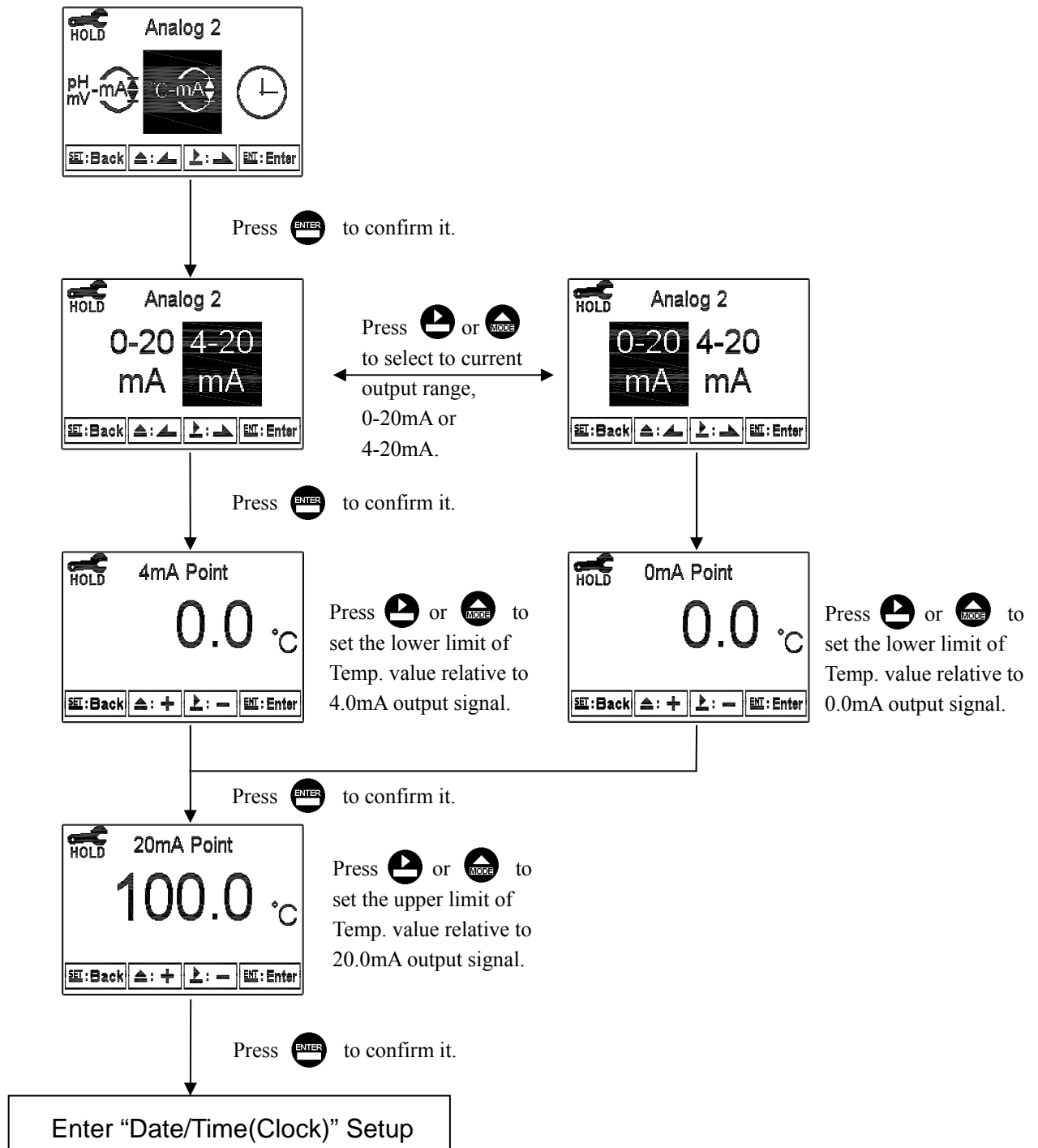



## 6.11 Date/Time(Clock)

Enter setup of Date/Time(Clock). Set the “Year”, “Month”, “Date”, “Hour”, and “Minute” time. Note: The clock needs to be reset after a power failure.

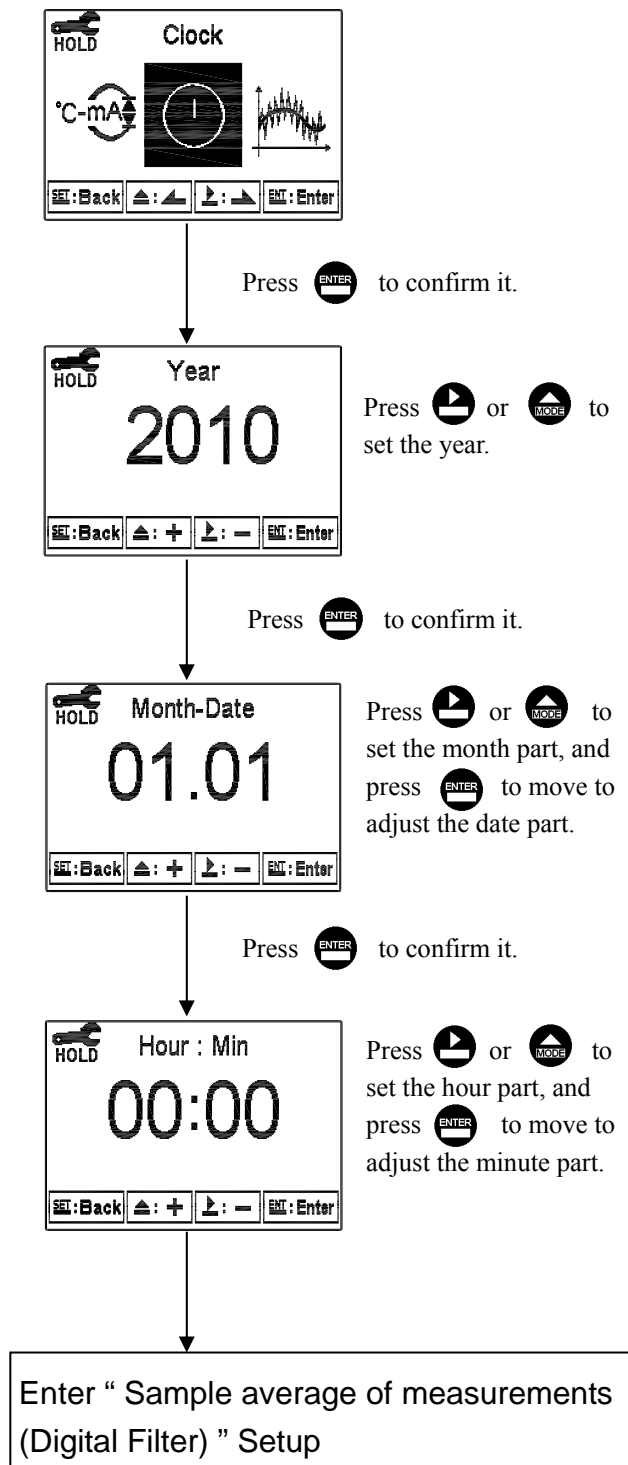

## 6.12 Sample average of measurements (Digital Filter)

Enter the setup of Digital filter. You may select the number of samples to be averaged each time to increase the stability of measurement.

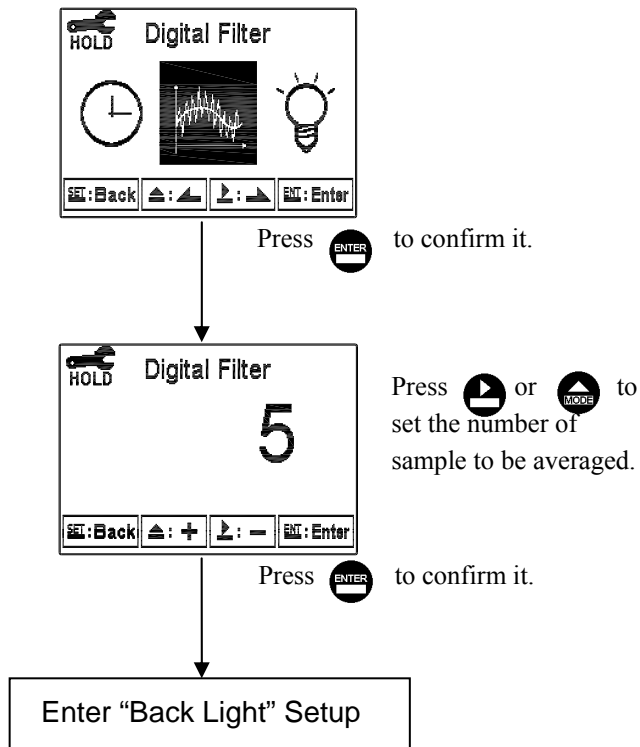

### 6.13 Backlight settings

Enter setup of backlight display. As needed, you can set the brightness of the display and sensitivity of the backlight sensor.

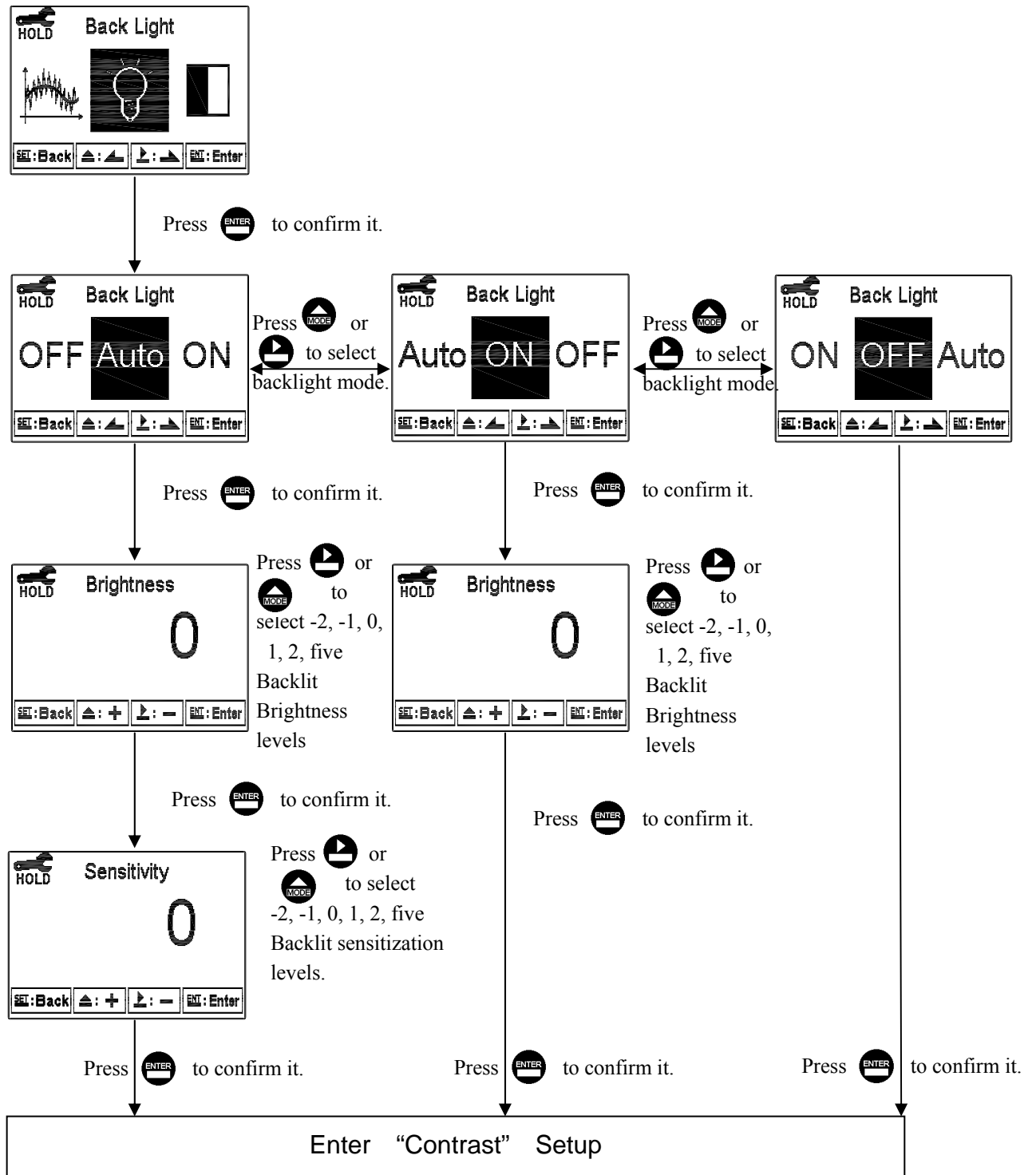

## 6.14 Contrast settings

Enter setup of display contrast. You can set the contrast of display according to your need.

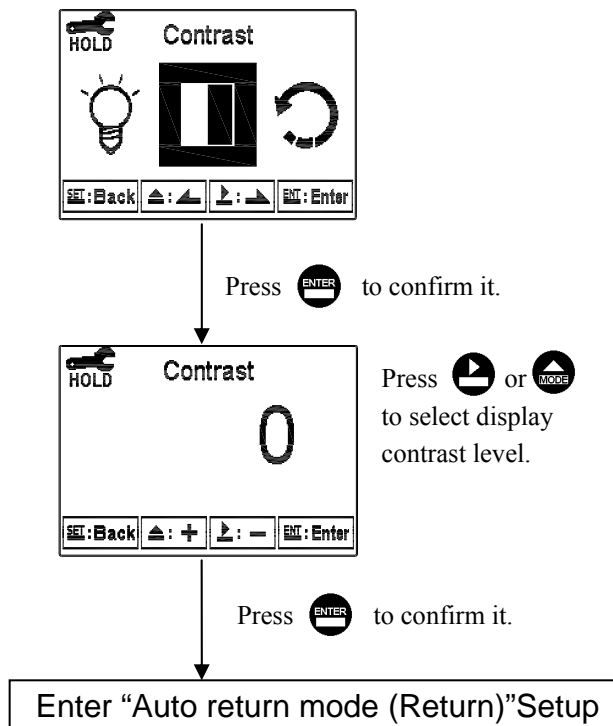

## 6.15 Return

Enter setup of auto return mode (Return) to set the function that the instrument automatically exit the setup menu after a period of time without pressing any key. The “Manual Exit” means that it needs to exit setup menu manually, while “Auto” means that the display automatically exits the setup menu and returns to measurement mode after a period of time without pressing any key.

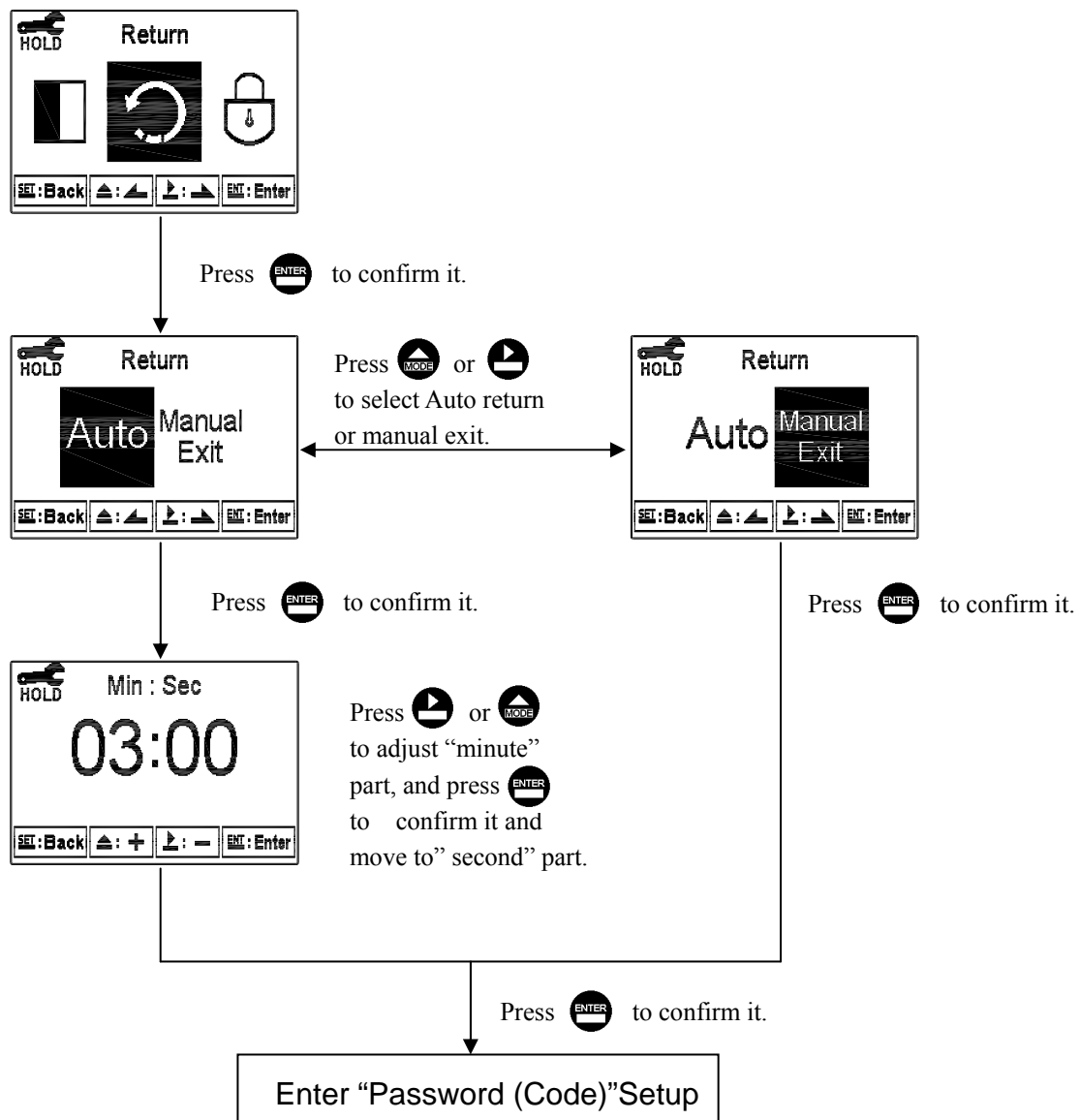

# 7. Calibration

## Block diagram of Calibration

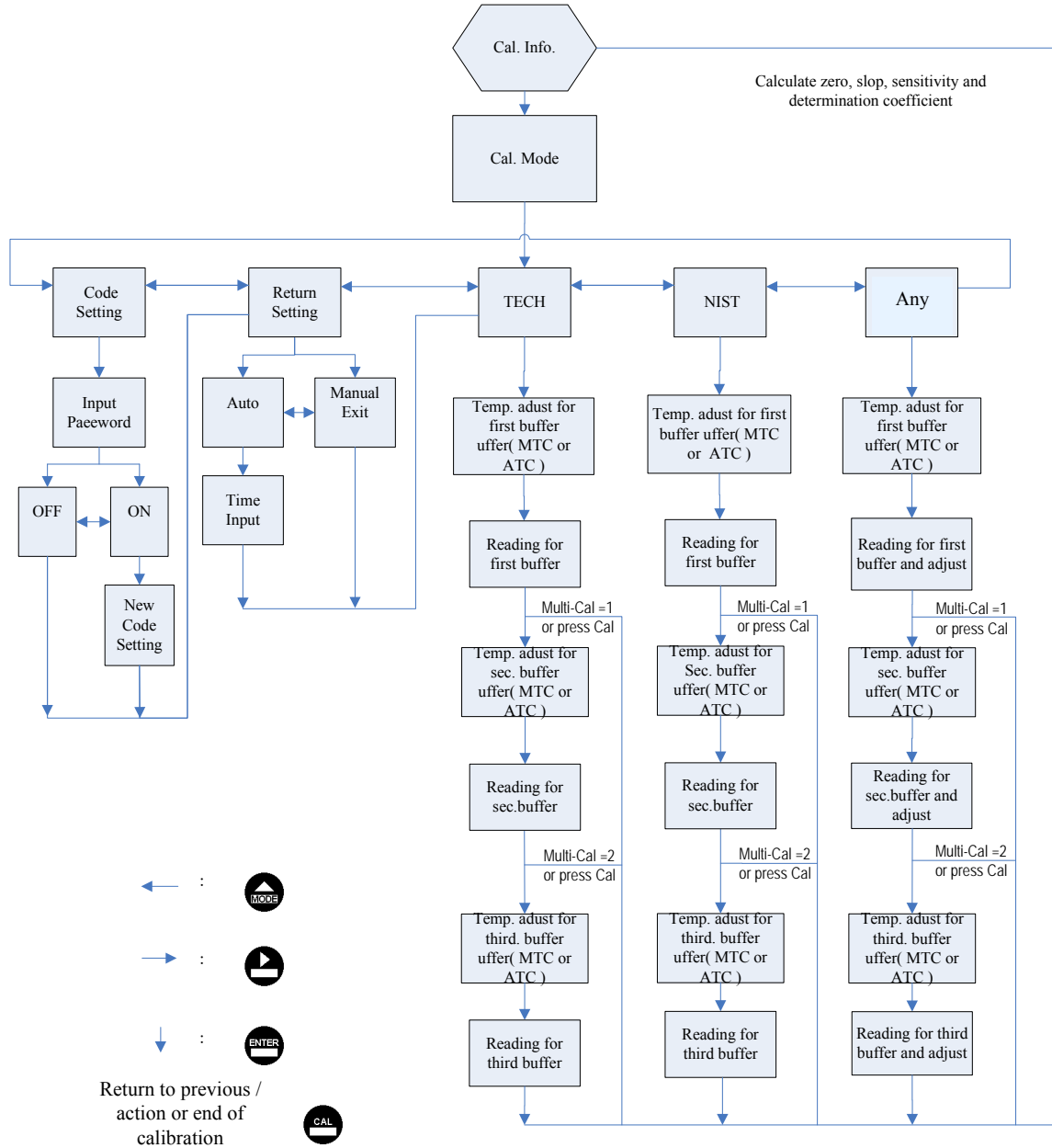

## 7.1 Enter calibration setup menu

In the measurement mode, pressing the two keys **CAL** and **MODE** simultaneously allows you enter the Calibration Information. If you do not need to re-calibrate the measurement system, press **CAL** to go back to measurement mode. If you need to re-calibrate the system, press **ENTER** to enter the calibration setup menu.

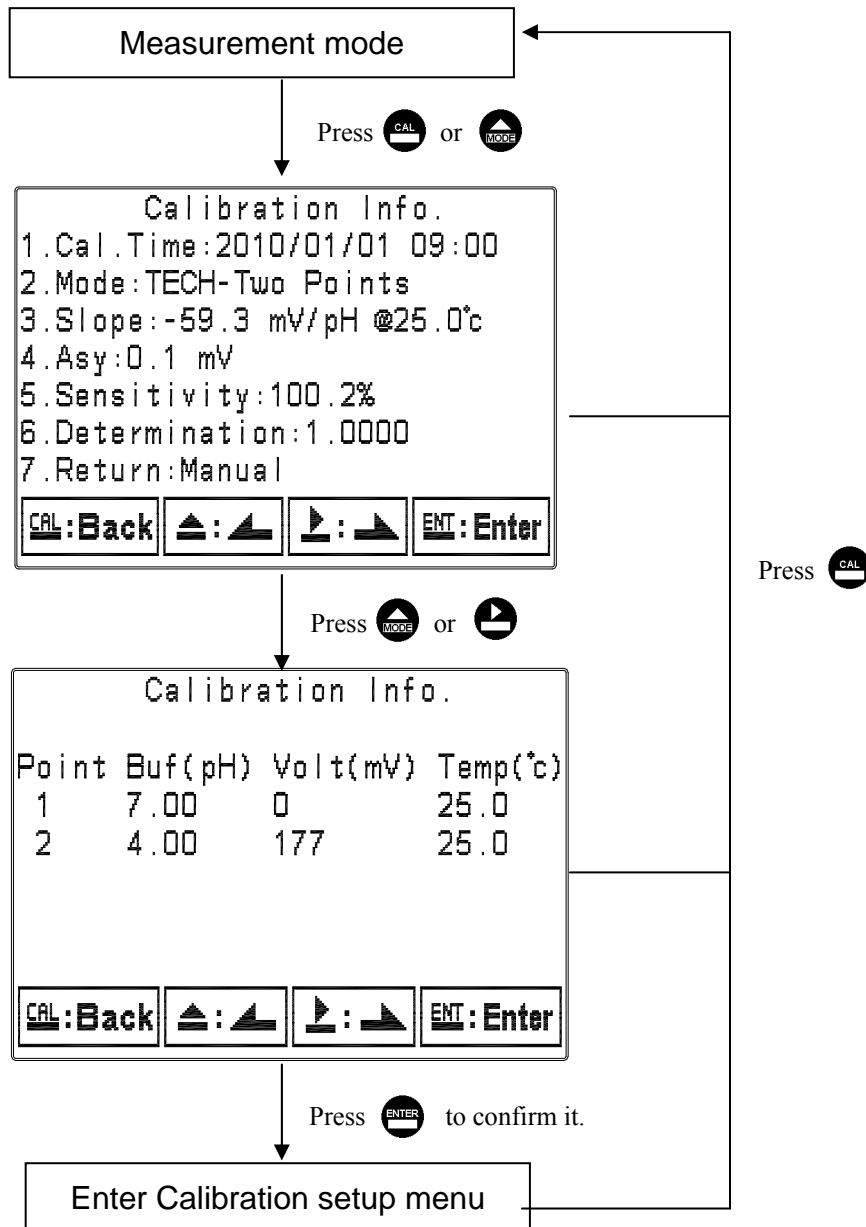

## 7.2 Security password of calibration (Code)

Select the Code (password) icon after entering calibration setup mode. Select to activate code function or not. The default Calibration setting code is “1100”.

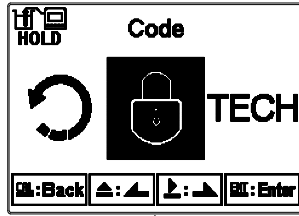

Press to confirm it.

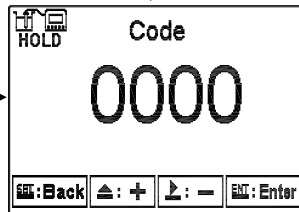

The first '0' of digits '0000' start to twinkle. Press or to adjust the value, and then press to confirm it and continually key in the next digit, and so on.

If you input a wrong code, then the display shows a “Error 5” message. Press to restart inputting another code, or press to exit the calibration menu.

Press to confirm it.

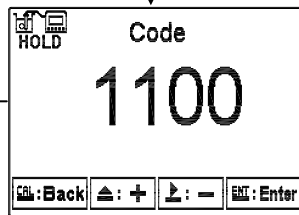

If you input a wrong code, then the display shows a “Error 5” message. Press to restart inputting another code, or press to exit the calibration menu.

(Select to turn on or turn off code protection function. If you select turn on, please key in a new code. There will be a code requirement showing in display when you re-enter to the setup mode. Key in the correct password to enter into calibration setup menu.)

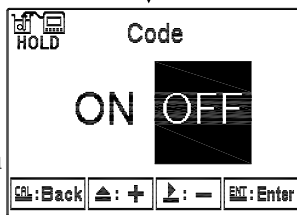

Press or

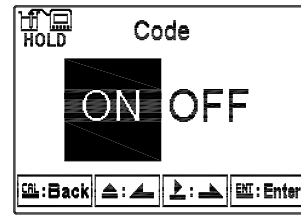

Press to confirm it.

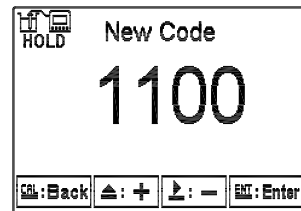

Input new code

Press to confirm it.

Enter “Auto return mode (Return)”Setup



## 7.4 pH Calibration

The instrument provides multi-point standard buffer solution calibration. You may decide how many points to calibrate the measurement system (up to 3-point). The principle is according to “Method of Least Squares”. Apply linear regression to calibration the electrode’s slope and zero point (Asy, Offset or Zero point).

When calibrating a electrode, you may calibrate 1 to 3 point by any sequence to provide linear regression for mV and pH multi-calibration of a electrode, and to show the electrode’s slope and zero point (Asy, offset or Zero point) at 25°C. The electrode’s slope rate which is actual slope divided by theoretical slope and the sensitivity shows in percentage in the display. In addition, the display shows the linear regression determination coefficient, R<sup>2</sup>, of the electrode and buffer solution to provide you an estimation of an electrode’s regression suitability. According to different combination of standard buffers, the TECH, NIST, Any buffer solution calibration modes are provided.

### 7.4.1 TECH mode (Up to 3-point calibration)

The electrode is automatically calibrated according to pH value and temperature of TECH standard buffers. The range of zero point and slope of the electrode is also determined. If one of them is over the range, the display shows error message of zero point and slope failure. (See appendix Table 1, pH/temperature table of TECH standard buffers)

### 7.4.2 NIST mode (Up to 3-point calibration)

The electrode is automatically calibrated according to pH value and temperature of NIST standard buffers. The range of zero point and slope of the electrode is also determined. If one of them is over the range, the display shows error message of zero point and slope failure. (See appendix Table 2, pH/temperature table of NIST standard buffers)

### 7.4.3 Any mode (Up to 3-point calibration)

The electrode measures mV value of different standard solutions. According to theoretic slope and the temperature of standard solutions, the display shows a approximate pH value. Then, you can calibrate the electrode by freely adjust the pH value as those of the standard solutions’. There is not a zero point range failure determination by the instrument but only the slope range determination. If the slope is over the range, the display shows error message of slope failure.

#### 7.4.4 Definition of calibration parameter

You can calibrate the electrode by one point or up to three points of standard solutions in any sequence. As different calibration point method is applied, the definition of the zero point and slope is different.

Calibration point	Determination	The showed calibration value
One point calibration	Asy	Zero point (Asy, offset or Zero point)= Asy 1.If not calibrated, Slope = Theoretical slope 2.If calibrated, Slope = Slope of last calibration
Two or three point calibration	Asy Slope	Zero point (Asy, offset or Zero point)= Asy Slope = Slope* Note: To obtain a new zero point(Asy) and Slope by applying linear regression.

## **9. Maintenance**

Generally speaking, under normal operation, the controllers produced by our company, need no maintenance. Regular cleaning and calibration of the electrode is suggested to ensure accurate and stable measurement and system operation.

The cleaning cycle for the electrode depends on the degree of contamination from the measured sample. Generally speaking, it is recommended to do weekly cleaning. See electrode instructions for cleaning details.

## 7.4.6 Any Calibration

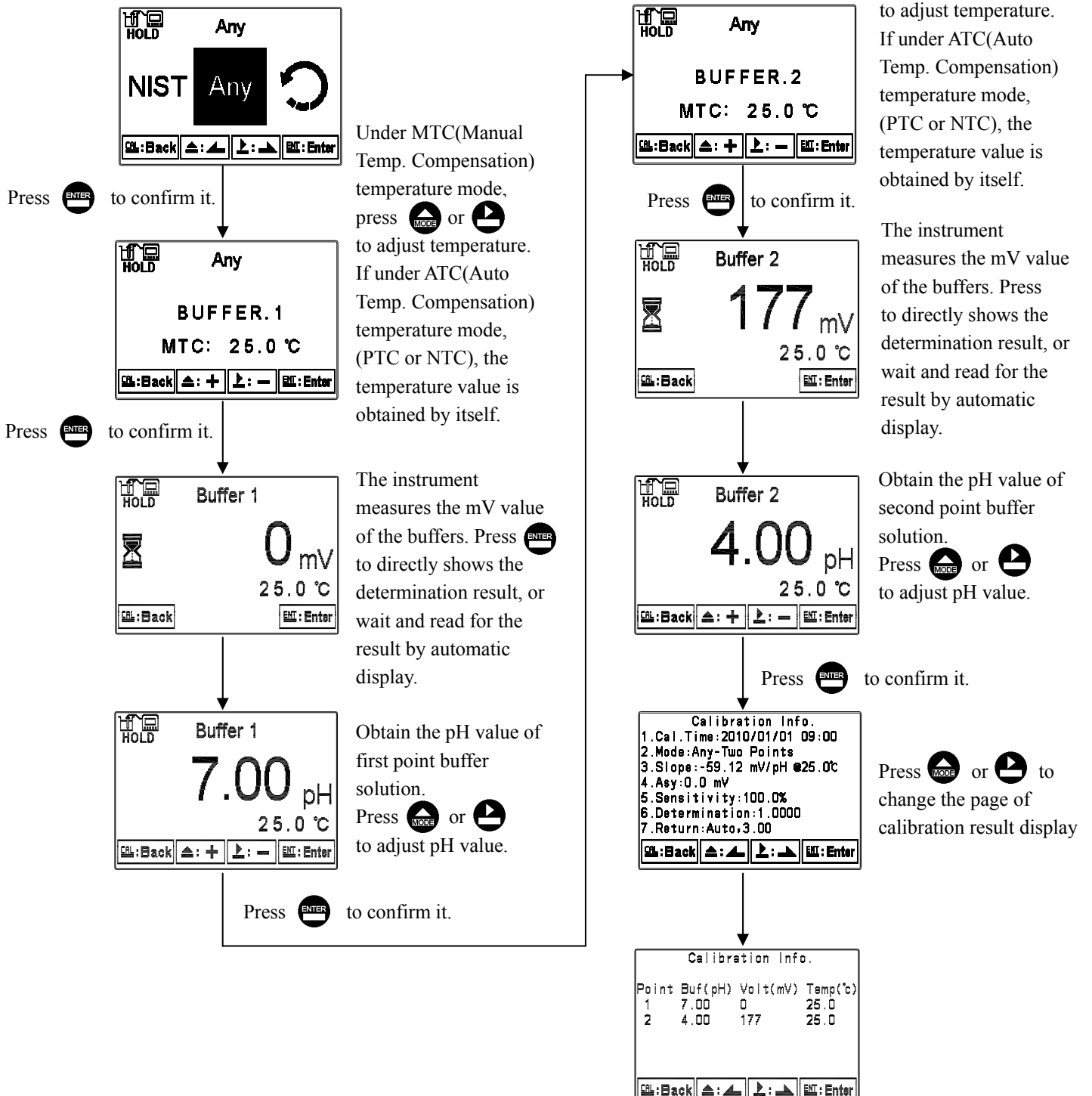

The procedure below is two points calibration of Any mode. First, enter the setup of Multi-points calibration and set the number of calibration point for 2. (See chapter 6.4 Multi-Cal) Then, go to Calibration menu and select “Any” mode. Operate the instrument as follow procedure diagram.

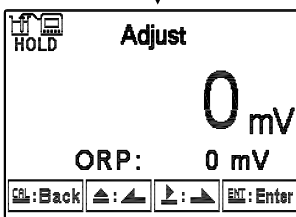
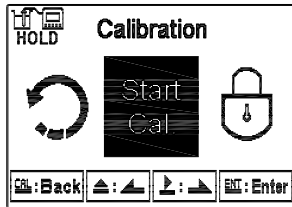

## 7.5 ORP Calibration

Under ORP measurement mode, enter calibration setup menu. Select Calibration icon, and adjust mV value. The adjustable range is from -300mV to 300mV.



Put the ORP electrode into ORP standard solution. Press  or  to adjust the main display value until it is equal to the desired mV value.

Press  to confirm it.

## 8. Error messages (Error code)

Messages	Reason	Dispositions
<b>Error9</b>	Serious error that does not permit any further measuring	Please call customer service.
<b>Error4</b>	<ol style="list-style-type: none"> <li>1. During calibration, the buffer solution temperature exceeds a range of 5~50°C</li> <li>2. The buffer can not be identified.</li> </ol>	<ol style="list-style-type: none"> <li>1. Please adjust the buffer solution temperature to the appropriate temperature range and make another calibration.</li> <li>2. Please replace the buffer, or maintain or replace the electrode and make another calibration.</li> </ol>
<b>Error3</b>	The readout is unstable	Please check whether there is bubble or air in the glass end of the electrode; maintain the electrode or change a new electrode, and make another calibration.
<b>Error2</b>	SLOPE value exceeds the upper or lower limit	Clean the electrode or change to a new electrode, and make another calibration.
<b>Error1</b>	OFFSET(zero-point electric potential) value $\geq$ 60mv	Clean the electrode or change to a new electrode, and make another calibration.

## **9. Maintenance**

Generally speaking, under normal operation, the controller produced by our company needs no maintenance except regular cleaning and calibration of the electrode to ensure accurate and stable measurement and system operation.

The cleaning cycle for the electrode depends on the pollution degree of the measurement sample. Generally speaking, it is recommended to do weekly cleaning. See electrode instructions for cleaning details.

## Appendix

Table 1

TECH Mode	TECH buffers		
TEMP°C	Buffer 4.01	Buffer 7	Buffer 10
5	3.999	7.087	10.241
10	3.998	7.053	10.155
15	3.999	7.031	10.116
20	4.002	7.011	10.047
25	4.006	6.996	9.998
30	4.011	6.985	9.952
35	4.018	6.976	9.925
40	4.031	6.971	9.874
45	4.047	6.969	9.843
50	4.055	6.969	9.810

Table

NIST Mode	NIST standard buffers(DIN 19266)				
TEMP°C	Buffer 1.68	Buffer 4.01	Buffer 6.86	Buffer 9.18	Buffer 12.45
5	1.668	4.004	6.951	9.395	13.207
10	1.670	4.000	6.923	9.332	13.003
15	1.672	3.999	6.900	9.276	12.810
20	1.675	4.001	6.881	9.225	12.627
25	1.679	4.006	6.865	9.180	12.454
30	1.683	4.012	6.853	9.139	12.289
35	1.688	4.021	6.844	9.102	12.133
40	1.694	4.031	6.838	9.068	11.984
45	1.700	4.043	6.834	9.038	11.410
50	1.707	4.057	6.833	9.011	11.705