

R9905

REED INSTRUMENTS

Data Logging Indoor Air Quality Meter



Instruction
Manual



www.REEDInstruments.com

.800.561.8187

www.itm.com

information@itm.com

Table of Contents

Introduction	3
Product Quality.....	4
Safety	4
Features.....	4
Included.....	5
Specifications	5-6
Instrument Description	7
Display Description	8
Operating Instructions.....	9-16
<i>Power ON/OFF</i>	9
<i>Taking Measurements</i>	9
<i>Unit of Measurement Selection (°C/°F)</i>	9
<i>Data Hold</i>	9
<i>Min/Max and Average Readings</i>	10
<i>Backlight</i>	11
<i>Setup Mode</i>	11
<i>Setting the Data Logging Sampling Rate</i>	11-12
<i>Setting the Relative Humidity/Temperature Offset</i>	12
<i>Setting the CO₂ Offset</i>	12
<i>Setting Altitude Compensation</i>	12-13
<i>Set CO₂ Alarm Values (Hi/Lo)</i>	13-14
<i>Setting the Auto-Power Off Time</i>	14
<i>Setting the Time and Date</i>	15
<i>Data Logging</i>	16
<i>Upload Recorded Data to PC</i>	16
<i>Software Installation</i>	16
<i>Clearing Stored Data</i>	16

continued...

Calibration Mode.....	17-19
CO ₂ Calibration.....	17-18
Humidity/Temperature Calibration.....	18-19
Calibrating Hi RH	18-20
Calibrating Lo RH.....	18
Calibrating Hi Temp.....	19
Calibrating Lo Temp.....	19-20
Battery Replacement.....	20
Applications.....	20
Accessories and Replacement Parts	20
Appendix A – Recommended Guidelines.....	21
NIOSH Recommendations	21
ASHRAE Standard 62 to 1989: 1000ppm	21
Building Bulletin 101 (BB101): 1500ppm	21
OSHA: 5000ppm	21
Germany, Japan, Australia: 5000ppm.....	21
Product Care	21
Product Warranty	22
Product Disposal and Recycling	22
Product Support.....	22

Introduction

Thank you for purchasing your REED R9905 Data Logging Indoor Air Quality Meter. Please read the following instructions carefully before using your instrument. By following the steps outlined in this manual your meter will provide years of reliable service.

Product Quality

This product has been manufactured in an ISO9001 facility and has been calibrated during the manufacturing process to meet stated product specifications. If a certificate of calibration is required please contact the nearest authorized REED distributor or authorized Service Center. Please note an additional fee for this service will apply.

Safety

- Never attempt to repair or modify your instrument. Dismantling your product, other than for the purpose of replacing batteries, may cause damage that will not be covered under the manufacturer's warranty. Servicing should only be provided by an authorized service center.
- Avoid condensation on CO₂ sensor.
- Do not hold the meter in close proximity to your mouth as exhalation affects CO₂ levels.
- Do not calibrate the meter in the air with unknown CO₂ concentration.

Features

- Triple LCD display simultaneously monitors carbon dioxide (CO₂), temperature and relative humidity
- Calculates time-weighted average (TWA) and short-term exposure limit (STEL)
- Low-drift NDIR CO₂ sensor for stable and accurate readings
- Temperature and relative humidity measurements help determine thermal comfort
- Easy-to-read backlit LCD display
- User adjustable audible alarm
- Data hold, Max/Min and Average functions
- Record up to 32,000 datapoints and keep track with internal time and date stamp
- User selectable sampling rate from 1 to 60 mins
- Low battery indicator and auto shut-off

Included

- USB Cable
- Hard Carrying Case
- Batteries

Specifications

Temperature

Measuring Range:	-4 to 140°F (-20 to 60°C)
Accuracy:	±1.5°F (±0.8°C)
Resolution:	0.1°F/°C

Humidity

Measuring Range:	0 to 100% RH
Accuracy:	10 to 90% RH: ±3% <10% & >90% RH: ±5%
Resolution:	0.1% RH

CO₂ (Carbon Dioxide)

Sensor Type:	Nondispersive Infrared (NDIR)
Measuring Range:	0 to 30,000ppm
Accuracy:	0 to 5000ppm: ±(75ppm + 3% rdg.) 5001 to 30,000ppm: ±(150 ppm +5% rdg.)
Resolution:	1ppm
Warm-up Time:	20 seconds
Sampling Rate:	2 seconds

General Specifications

Display:	LCD
Backlit Display:	Yes
Data Hold:	Yes
Min, Max, Avg Functions:	Yes
CO ₂ Short Term Exposure Limit (STEL):	Yes (15 minutes)

continued...

REED

www.REEDInstruments.com

5

.800.561.8187

www.itm.com

information@itm.com

CO ₂ Time Weighted Average (TWA):	Yes (8 hours)
Datalogging Capabilities:	Yes
Real-Time Clock and Date Stamp:	Yes
Selectable Sampling Rate:	Yes (between 1s and 60m59s)
Internal Memory:	Yes (32,000 datapoints)
Alarms:	Yes (Low and High)
Auto Shut-off:	Yes (adjustable)
Kick Stand:	Yes
Low Battery Indicator:	Yes
Power Supply:	9V battery
Battery Life:	Approx. 10 hours (continuous use)
PC Connectivity:	USB
Software OS Compatibility:	Windows 7/8/10/11
Product Certifications:	CE
Operating Temperature:	32 to 122°F (0 to 50°C)
Storage Temperature:	-4 to 140°F (-20 to 60°C)
Operating Humidity Range:	0 to 90%
Storage Humidity Range:	10 to 75%
Maximum Operating Altitude:	6561' (2000m)
Dimensions:	11.2 x 2.6 x 1.5" (284 x 65 x 39mm)
Weight:	10.7oz (304g)

Instrument Description

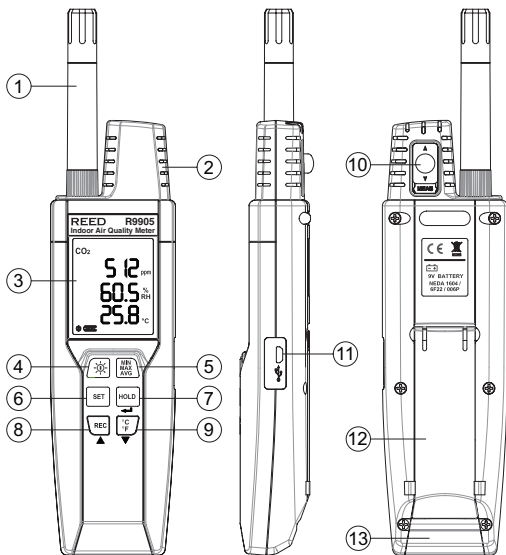

- | | |
|-------------------------------|---------------------------------------|
| 1. Temp/Humidity Probe | 8. REC Button |
| 2. CO ₂ Sensor | 9. °C/°F Button |
| 3. LCD Display | 10. CO ₂ Calibration Inlet |
| 4. Power and Backlight Button | 11. USB Interface |
| 5. MIN MAX AVG Button | 12. Tilt Stand |
| 6. SETUP Button | 13. Battery Compartment |
| 7. DATA HOLD Button | |

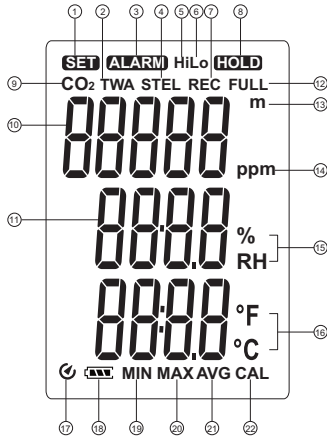

Display Description



- | | |
|--|--|
| 1. Setup Indicator | 12. Memory Full Indicator |
| 2. Time Weighted Average Indicator | 13. Altitude Measurement Unit |
| 3. CO ₂ Alarm Indicator | 14. CO ₂ Measurement Unit |
| 4. Short-term Exposure Limit Indicator | 15. Relative Humidity Measurement Unit |
| 5. Hi CO ₂ Alarm Indicator | 16. Temperature Measurement Unit |
| 6. Lo CO ₂ Alarm Indicator | 17. Auto Power Off Enabled Indicator |
| 7. Recording Data Logger Indicator | 18. Battery Status Indicator |
| 8. Data Hold Indicator | 19. Minimum Indicator |
| 9. CO ₂ Measurement Indicator | 20. Maximum Indicator |
| 10. CO ₂ Reading | 21. Average Indicator |
| 11. Relative Humidity/ Temperature Reading | 22. Calibration Mode |

Operating Instructions

Power ON/OFF

Turn the meter on by pressing the  button. To turn the meter off, press and hold the  button for 3 seconds.

Taking Measurements

The meter starts taking measurements when powered on and updates readings every 2 seconds.

Note: Make sure the CO₂ sensor is switched to "MEAS" position and not the "CAL" position.

Rapid environment changes (i.e., moving your meter from indoors to outdoors) may cause inaccurate readings, therefore, it is always recommended to allow your meter to get acclimated to its new environment (approx. 10 to 15 minutes). Do not hold the meter close to your mouth or any other source of CO₂.



Unit of Measurement Selection (°C/°F)

When the meter is powered on press the  button to toggle between Celsius and Fahrenheit.

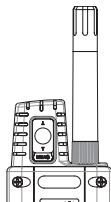
Note: The default unit of measurement is Celsius (°C). The meter will automatically save the last selected unit of measure when turned off.



Data Hold

Press the  button to freeze the current reading on the display. Press the  button again to resume normal operation.

Note: When the Data Hold function is enabled the ,  and  buttons are disabled.

continued...

REED

www.REEDInstruments.com

9





.800.561.8187

www.itm.com



information@itm.com

Min/Max and Average Readings

When in this mode, the unit simultaneously monitors and stores the minimum, maximum and average values into the internal memory while continuously updating/refreshing the measurement values.

1. Press the  button once, the **MIN** indicator will appear on the LCD display. The minimum values (CO₂, humidity and temperature) are displayed and will automatically update when new minimum data values are measured.
2. Press the  button again and the **MAX** indicator will appear on the LCD display. The maximum values (CO₂, humidity and temperature) are displayed and will automatically update when new maximum data values are measured.
3. Press the  button a third time and the short-term exposure limit (STEL) indicator will now appear on the LCD display. The STEL average limit for the past 15 minutes will be displayed and will automatically be updated every minute.
4. Press the  button a fourth time and the time weight average (TWA) indicator will now appear on the LCD display. The TWA limit for the past 8 hours will be displayed and will automatically be updated every 10 minutes.

If the meter has been powered on for less than 15 minutes, the STEL and TWA values will only reflect the weighted average of readings taken since it was powered on. If the meter does not have enough data to display STEL and TWA, "—" will appear on LCD display.



5. Press the  button a fifth time and the "MAX, MIN, STEL and TWA" indicators will blink simultaneously while continuing to update the readings in memory and can be viewed by returning to the appropriate function. While in this function, the meter is displaying the current measurement values only.
6. Press and hold the  button for 2 seconds to exit MAX/MIN/AVG mode and resume normal operation.

continued...

Backlight

Press the  button to turn the LCD Backlight on or off. The backlight will automatically turn off after 30 seconds to preserve battery life.

Setup Mode

1. Press the  button to enter Setup mode.
2. Press the   button continuously to scroll through the following parameters and applicable parameter values.

Note: At any time, you can press the  button to exit setup mode and resume normal operation.

Parameter	Description
Int	Set the data logging sampling rate
OFS (%RH/°F)	Set the Relative Humidity/Temperature offset
OFS (ppm)	Set the CO ₂ offset
Alt	Set altitude compensation
ALARM	Set CO ₂ Alarm Values (Hi/Lo)
	Set the auto-power off time
2021 1108 0906	Set the time and date

Setting the Data Logging Sampling Rate

Follow steps 1 through 4 when "Int" appears on the LCD as shown in Figure 1.





1. The sampling rate can be set from "1" second (00:01) up to 60 minutes and 59 seconds (60:59).
2. Press the  and  buttons to adjust the required sampling rate by minutes or seconds.
3. Press the   button to confirm each selection.



Figure 1

continued...

4. Press the **HOLD**  button again to skip to next parameter.

Note: At any time, you can press the **SET** button to exit setup mode and resume normal operation.

Setting the Relative Humidity/Temperature Offset

Follow steps 1 through 5 when "OFS" appears on the LCD as shown in Figure 2.



1. Press the **▲** and **▼** buttons to increase or decrease the required Humidity Offset.
2. Press the **HOLD**  button to confirm selection.
3. Press the **▲** and **▼** buttons to increase or decrease the required Temperature Offset.
4. Press the **HOLD**  button to confirm selection.
5. Press the **HOLD**  button again to skip to next parameter.



Figure 2

Note: At any time, you can press the **SET** button to exit setup mode and resume normal operation.

Setting the CO₂ Offset

Follow steps 1 and 2 when "OFS" appears on the LCD as shown in Figure 3.

1. Press the **▲** and **▼** buttons to increase or decrease the required CO₂ Offset.
2. Press the **HOLD**  button to confirm selection and skip to next parameter.



Figure 3

Note: At any time, you can press the **SET** button to exit setup mode and resume normal operation.

Setting Altitude Compensation

Follow steps 1 through 8 when "ALT" appears on the LCD as shown in Figure 4.





1. Press the **▲** and **▼** buttons to increase or decrease the 1st digit.
2. Press the **HOLD**  button to confirm selection and skip to the 2nd digit.



Figure 4

continued...







3. Press the ▲ and ▼ buttons to increase or decrease the 2nd digit.
4. Press the  ◀ button to confirm selection and skip to the 3rd digit.
5. Press the ▲ and ▼ buttons to increase or decrease the 3rd digit.
6. Press the  ◀ button to confirm selection and skip to the 4th digit.
7. Press the ▲ and ▼ buttons to increase or decrease the 4th digit.
8. Press the  ◀ button to confirm selection and skip to the next parameter.

Note: At any time, you can press the  button to exit setup mode and resume normal operation.

Altitude compensation can be set from 0 to 3000m.
By default, the meter is set to 0000m. It is strongly recommended that the correct altitude compensation is set in order for the meter to provide accurate measurements.

Set CO₂ Alarm Values (Hi/Lo)

Follow steps 1 through 8 when "ALARM" appears on the LCD as shown in Figure 5.

1. Press the ▲ and ▼ buttons to turn the CO₂ alarm On or OFF.
2. Press the  ◀ button to confirm selection and set the CO₂ alarm values when enabled.
3. Press the ▲ and ▼ buttons to increase or decrease the 1st digit of the high alarm value.
4. Press the  ◀ button to confirm selection and skip to the 2nd digit.
5. Press the ▲ and ▼ buttons to increase or decrease the 2nd digit.
6. Press the  ◀ button to confirm selection and skip to the 3rd digit.
7. Press the ▲ and ▼ buttons to increase or decrease the 3rd digit.
8. Press the  ◀ button to confirm selection and skip to the 4th digit.
9. Press the ▲ and ▼ buttons to increase or decrease the 4th digit.
10. Press the  ◀ button to confirm selection and skip to the 5th digit.
11. Press the  ◀ button to confirm selection and skip to the low CO₂ alarm value setup.

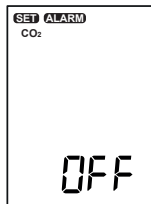













Figure 5

continued...

12. Press the ▲ and ▼ buttons to increase or decrease the 1st digit of the low alarm value.
13. Press the   button to confirm selection and skip to the 2nd digit.
14. Press the ▲ and ▼ buttons to increase or decrease the 2nd digit.
15. Press the   button to confirm selection and skip to the 3rd digit.
16. Press the ▲ and ▼ buttons to increase or decrease the 3rd digit.
17. Press the   button to confirm selection and skip to the 4th digit.
18. Press the ▲ and ▼ buttons to increase or decrease the 4th digit.
19. Press the   button to confirm selection and skip to the 5th digit.
20. Press the ▲ and ▼ buttons to increase or decrease the 5th digit.
21. Press the   button to confirm selection and skip to the next parameter.

Note: At any time, you can press the  button to exit setup mode and resume normal operation. When an alarm is triggered, the meter will beep while the applicable ALARM indicator (Hi or Lo) will continuously flash on the LCD display.

Setting the Auto-Power Off Time

Follow steps 1 through 3 when "  " appears on the LCD as shown in Figure 6.



1. The auto-power off time can be set between 10, 30 minutes, 1, 2, 4, 8 hours, or off.
2. Press the ▲ and ▼ buttons to adjust the required auto-power off time.
3. Press the   button to confirm selection and skip to the next parameter.









Figure 6

Note: At any time, you can press the  button to exit setup mode and resume normal operation.

continued...

Setting the Time and Date

Follow steps 1 through 12 when the date appears on the LCD as shown in Figure 7.

1. Press the ▲ and ▼ buttons to set the last 2 digits of the applicable year.
2. Press the  ← button to confirm selection and skip to the first 2 digits of the applicable year.
3. Press the ▲ and ▼ buttons to set the first 2 digits of the applicable year.
4. Press the  ← button to confirm selection and skip to the Month digits.
5. Press the ▲ and ▼ buttons to set the applicable month.
6. Press the  ← button to confirm selection and skip to the Date digits.
7. Press the ▲ and ▼ buttons to set the applicable date.
8. Press the  ← button to confirm selection and skip to the hour digits.
9. Press the ▲ and ▼ buttons to set the hour digits.
10. Press the  ← button to confirm selection and skip to the minute digits.
11. Press the ▲ and ▼ buttons to set the minute digits.
12. Press the  ← button to confirm selection and skip to the next parameter.

Note: At any time, you can press the  button to exit setup mode and resume normal operation. The internal clock will keep accurate time when the meter is powered off. When new batteries are installed the clock will have to be reset.

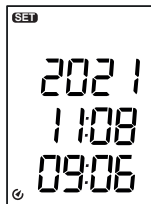



Figure 7

continued...

Data Logging

1. Turn the meter on and select your desired sampling rate. (see "Setting the Data Logging Sampling Rate" for details).
2. To begin a data logging session, press the  button and "REC" will appear on the LCD.
3. Press the  button again to stop data logging.

Note: When the internal memory is full (32,000 data points), the **FULL** indicator will blink on the LCD and the recording session stops.

Upload Recorded Data to PC

Connect the R9905 via the included USB cable to a port on your PC to download the recorded data. For steps to follow on how to use the software, please refer to the instructions provided in the HELP section within the software program.

Software Installation

Please visit www.REEDInstruments.com/software to download the R9905 software.

Full specifications and Operating System compatibility can be found on the product page at www.REEDInstruments.com. If you have specific questions related to your application and/or questions related to software setup and functionality please contact the nearest authorized distributor or Customer Service at info@reedinstruments.com or 1-877-849-2127.

Clearing Stored Data

1. To delete the internal memory, press and hold the  button while powering on the meter.
2. The display will show a 5 seconds countdown along with the "REC", "CLR" and "SURE" indicators.
3. Once the countdown is completed "CLR" will display confirming the memory has been erased.
4. Release the buttons when the meter emits a beep.

Note: To cancel the clearing of stored data, release both buttons before the countdown ends.

Calibration Mode

CO₂ Calibration

The R9905 can be field calibrated using the internal calibration menu. These adjustments are intended to make calibration changes to match a user's calibration standards and is not considered a certified calibration. For multi-point calibration and certification, please contact the nearest authorized REED distributor or authorized service center.

The R9905 CO₂ sensor can be calibrated with span gas (cylinder with a very specific concentration of carbon dioxide) that has a concentration ranging anywhere between of 0 to 2000ppm, 2% accuracy, with balanced air.

Note: It is recommended to use a span gas value close to the gas concentration you expect to measure.

1. Switch the CO₂ sensor to the "CAL" position as shown in Figure 1.
2. Remove the protective cap.
3. Connect the silicone tubing to the calibration inlet of the sensor as shown in Figure 2.
4. While the meter is off, press the **SET**, **MN MAX AVG**, and the **30°C** buttons simultaneously for 3 seconds and release when the LCD displays " - - - ".
5. Press the **SET** -> **°C/°F** -> **°C/°F** buttons in sequence and within 3 seconds to enter CO₂ calibration mode.
6. The CAL indicator will appear at the bottom right of the LCD display confirming the meter is now in CAL mode.

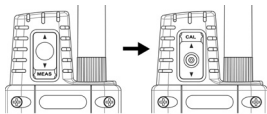

Figure 1

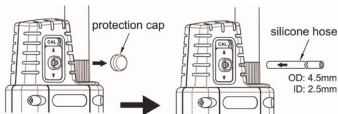

Figure 2

continued...

REED



www.REEDInstruments.com

17

.800.561.8187







www.itm.com

information@itm.com

7. The upper part of the LCD will display the current CO₂ measurement while the lower part of the LCD will display the CO₂ calibration gas concentration.
8. Press the ▲▼ buttons to increase/decrease the CO₂ value to match the concentration of the span gas.
9. Turn on the calibration gas valve.
10. The current CO₂ reading should begin to update.
11. Press the   button when current CO₂ reading has stabilized (approx. 2 minutes).
12. The LCD will display "PASS" if there are no errors.
13. Shut off the calibration gas valve when calibration is successfully completed.
14. Press the  button to exit calibration mode and resume normal operation.

Note: If the meter displays **OL**, make sure the altitude compensation value is set correctly.



Humidity/Temperature Calibration

1. While the meter is off, press the , , and the  buttons simultaneously for 3 seconds and release when the LCD displays "- - -".
2. Press the  ->  ->  buttons in sequence and within 3 seconds to enter humidity calibration.
3. Press the  button to select the desired channel (Hi RH, Lo RH, Hi Temp or Lo Temp) for calibration.



Calibrating Hi RH

1. The upper part of the LCD will display the "Hi" indicator while the lower part of the LCD will display the "Hi" RH calibration data point.
2. Insert the tip of the meter into the 75% Humidity Calibration Standard (REED R9975).
3. If using a different Hi calibration standard, press the ▲▼ buttons to increase/decrease the humidity value to match the humidity standard.

continued...



4. Press the   button after 2 to 3 minutes to save the calibration and skip to the "Lo" RH Calibration mode.

Calibrating Lo RH

1. The upper part of the LCD will display the "Lo" indicator while the lower part of the LCD will display the "Lo" RH calibration data point.
2. Insert the tip of the meter into the 33% Humidity Calibration Standard (REED R9933).
3. If using a different Lo calibration standard, press the ▲▼ buttons to increase/decrease the humidity value to match the humidity standard.
4. Press the   button after 2 to 3 minutes to save the calibration and skip to the "Hi" Temp Calibration mode.
5. When the Hi/Lo RH calibration steps have been successfully completed, press the  button to exit calibration mode and resume normal operation.

The steps highlighted below for Hi/Lo Temp calibration should only be performed by an authorized service center technician with the use of a temperature chamber as it may affect the meter's overall accuracy and reliability.

Calibrating Hi Temp

1. The upper part of the LCD will display the "Hi" indicator while the lower part of the LCD will display the "Hi" Temp calibration data point.
2. Insert the meter into the standard temperature chamber.
3. Press the ▲▼ buttons to increase/decrease the temperature value to match the temperature standard.
4. Press the   button after approx. 30 minutes to save the calibration and skip to the "Lo" Temp Calibration mode.

Calibrating Lo Temp

1. The upper part of the LCD will display the "Lo" indicator while the lower part of the LCD will display the "Lo" Temp calibration data point.
2. Insert the meter into the standard temperature chamber.

continued...

REED



www.REEDInstruments.com

19

.800.561.8187

www.itm.com

information@itm.com

3. Press the ▲▼ buttons to increase/decrease the temperature value to match the temperature standard.
4. Press the  button after approx. 30 minutes to save the calibration.
5. Press the  button to exit calibration mode and resume normal operation.

Battery Replacement

When the low battery indicator appears on the display, the battery should be replaced. Remove the battery cover on the back and insert a new 9V battery.

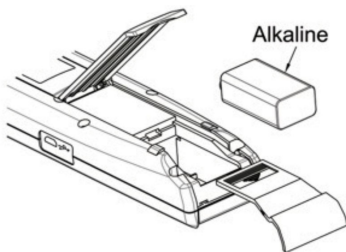

Applications

Environmental Monitoring in:

- Schools
- Office buildings
- Greenhouses
- Factories
- Hotels
- Hospitals
- Areas where high levels of carbon dioxide are generated

Accessories and Replacement Parts

- **R9905-PROBE** Replacement Temperature and Humidity Probe
- **R9933** Humidity Calibration Standard, 33%
- **R9975** Humidity Calibration Standard, 75%
- **R9980** Humidity Calibration Kit (33% and 75%)
- **R8890** Large Hard Carrying Case

Don't see your part listed here? For a complete list of all accessories and replacement parts visit your product page on www.REEDInstruments.com.

Appendix A – Recommended Guidelines

NIOSH Recommendations

- 250 to 350ppm: normal outdoor ambient concentrations.
- 600ppm: minimal air quality complaints.
- 600 to 1000ppm: less clearly interpreted.
- 1000ppm: indicates inadequate ventilation; complaints such as headaches, fatigue, and eye/throat irritation will be more widespread. 1000ppm should be used as an upper limit for indoor levels.

ASHRAE Standard 62 to 1989: 1000ppm

- CO₂ concentration in occupied building should not exceed 1000ppm.

Building Bulletin 101 (BB101): 1500ppm

- UK standards for schools say that CO₂ at averaged over the whole day (i.e. 9am to 3.30pm) should not exceed 1500ppm.

OSHA: 5000ppm

- Time weighted average over five 8-hour work days should not exceed 5000ppm.

Germany, Japan, Australia: 5000ppm

- 8 hours weighted average in occupational exposure limit is 5000ppm.

Product Care

To keep your instrument in good working order we recommend the following:

- Store your product in a clean, dry place.
- Change the battery as needed.
- If your instrument isn't being used for a period of one month or longer please remove the battery.
- Clean your product and accessories with biodegradable cleaner. Do not spray the cleaner directly on the instrument. Use on external parts only.

Product Warranty

REED Instruments guarantees this instrument to be free of defects in material or workmanship for a period of one (1) year from date of shipment. During the warranty period, REED Instruments will repair or replace, at no charge, products or parts of a product that proves to be defective because of improper material or workmanship, under normal use and maintenance. REED Instruments total liability is limited to repair or replacement of the product. REED Instruments shall not be liable for damages to goods, property, or persons due to improper use or through attempts to utilize the instrument under conditions which exceed the designed capabilities. In order to begin the warranty service process, please contact us by phone at 1-877-849-2127 or by email at info@reedinstruments.com to discuss the claim and determine the appropriate steps to process the warranty.

Product Disposal and Recycling



Please follow local laws and regulations when disposing or recycling your instrument. Your product contains electronic components and must be disposed of separately from standard waste products.

Product Support

If you have any questions on your product, please contact your authorized REED distributor or REED Instruments Customer Service by phone at 1-877-849-2127 or by email at info@reedinstruments.com.

Please visit www.REEDINSTRUMENTS.com for the most up-to-date manuals, datasheets, product guides and software.

*Product specifications subject to change without notice.
All rights reserved. Any unauthorized copying or reproduction of this manual is strictly prohibited without prior written permission from REED Instruments.*

REED

INSTRUMENTS

TEST & MEASURE WITH CONFIDENCE



CHECK OUT OUR LATEST PRODUCTS!

www.REEDInstruments.com

.800.561.8187

www.itm.com

information@itm.com

REED INSTRUMENTS

TEMPERATURE
& HUMIDITY



SOUND



MOISTURE



AIR VELOCITY



ELECTRICAL



www.REEDInstruments.com

.800.561.8187

www.itm.com

information@itm.com