

R9000

REED INSTRUMENTS

Video Inspection Camera



Instruction Manual

Table of Contents

Introduction	3
Product Quality.....	4
Safety	4-6
<i>Battery Pack Safety and Using Guide</i>	4-5
<i>Usage Tips</i>	5-6
Features.....	7
Included.....	7
Specifications.....	7-8
Instrument Description	9-12
<i>Camera Head</i>	9
<i>Cable Wheel and Push Cable</i>	9
<i>Battery Pack</i>	9
<i>Remote Control</i>	10
<i>DVR and Tool Box Contents Description</i>	11-12
<i>DVR Icon Description</i>	12
Operating Instructions.....	12-20
<i>Installation</i>	12-14
<i>Installing Camera Head</i>	12-13
<i>Installing the Support Guide Fitting</i>	13
<i>Installing the 1.8" (46mm) Support Guides</i>	13
<i>Installing the 3.15" (80mm) Support Guides</i>	13
<i>Installing the SD Card</i>	14
<i>DVR Function Guide</i>	14
<i>Live Video</i>	14
<i>Video Menu Options</i>	14-15
<i>Setting the Video Resolution</i>	15
<i>Set Recording Time</i>	15
<i>Enabling/Disabling Sound</i>	15
<i>Enabling/Disabling Timestamp</i>	15

continued...

<i>Playback Mode</i>	16
<i>Playback Settings</i>	16-18
<i>Deleting Media Files</i>	17
<i>Setting Interval Time</i>	17
<i>Protecting Media Files</i>	17
<i>Setting Thumbnail Viewer</i>	17
<i>File List Viewer</i>	18
<i>Volume Adjustment</i>	18
<i>Setup Mode</i>	18-20
<i>Formatting the SD Card</i>	18-19
<i>Adjusting LCD Brightness</i>	19
<i>Selecting System Language</i>	19
<i>System Reset</i>	19
<i>Setting Light Frequency</i>	19
<i>Selecting TV Output</i>	19
<i>Enabling/Disabling Date & Time</i>	20
Applications.....	20
Accessories and Replacement Parts.....	20
Product Care.....	21
Product Warranty.....	21
Product Disposal and Recycling.....	21
Product Support.....	22

Introduction

Thank you for purchasing your REED R9000 Video Inspection Camera. Please read the following instructions carefully before using your instrument. By following the steps outlined in this manual your meter will provide years of reliable service.

Product Quality

This product has been calibrated during the manufacturing process to meet the stated product specifications.

Safety

Read all safety warnings and instructions. To reduce the risk of electric shock, fire and/or serious personal injury, follow the warnings and instructions listed below.

- Save this operation manual for future reference.
- Do not operate this instrument in explosive atmospheres, such as in the presence of flammable liquids, gases, hazardous chemicals, superheated liquid or heavy dust. It may create sparks which may ignite the dust or fumes.
- The camera head and the push cable are waterproof (IP67 rated), however, the battery pack, DVR and connector cable are not. Do not expose them to water or rain as this increases the risk of electrical shock.
- Never point the connected camera in someone's eyes when the monitor is switched on as the LEDs are bright.
- Avoid using in environments of extreme cold, heat or humidity.
- Do not store or use the instrument and battery pack in locations where the temperature may reach or exceed 122°F (50°C).
- Do not drop the case as it may damage the instrument.
- Only authorized service centers are allowed to repair this instrument.
- Do not use the camera if condensation forms inside the lens. Let the water evaporate before using again.
- Do not use in places where there is high voltage equipment as it does not contain high voltage protection and isolation.
- Only use attachments/accessories specified by the manufacturer.

Battery Pack Safety and Guide

Read the following battery pack safety precautions before using the battery and charger to reduce the risk of electrical shock.

- Recharge the battery pack with the proper accessory charging unit to avoid any damage.

continued...

- Do not charge or use battery in explosive atmospheres, such as in the presence of flammable liquids, gases or dust. Inserting or removing the battery from the charger may ignite the dust or fumes.
- DO NOT splash or immerse in water or other liquids as it will increase the risk of electrical shock.
- Never attempt to open the battery pack. If battery pack case is cracked or damaged, do not insert into charger.
- Never connect the car charger to any 24 volt cigarette lighter slot as it will harm the battery pack and DVR.
- Do not disassemble charger or battery pack; send it to an authorized service center when service or repair is required. Incorrect reassembly may result in electrical shock or fire.
- If the skin comes into contact with battery contents, wash area with mild soap and water. If it gets into the eye, seek immediate medical attention.
- Plug the power adapter to the AC outlet, and insert the other end into the DC inlet located on top of the battery pack. During the charging process, the LED lights will be red and turn to green when fully charged. If the battery has been depleted for a long period of time, the charger will pre-charge the battery automatically for approx. 10 minutes, during which time the LED lights will be blink red.
- When the battery pack is turned on it will supply the system and the battery level will be indicated by the green LED indicators. There are 4 indicators and each represents 25% of the battery.
- Allow up to 8 hours to fully charge the battery. If possible, recharge the battery when the camera system is switched off. This increases the operational lifetime of the rechargeable battery.

Usage Tips

- Use a power adaptor or car charger to charge the battery pack.
- If the instrument will not be used for a long period of time, recharge the battery pack every 6 months.
- Always backup your data before connecting your SD memory card to this system.
- Do not disconnect the instrument while recording or during playback as it may damage the instrument and/or the SD memory card.

continued...

- Handle the cable with care at all times. The cable is made of a flexible material and can cause a whipping motion when tension is released. It is strongly recommended to protect your eyes with safety glasses during use.
- Suitable for pipes with a diameter of 0.98 to 7.87" (25 to 200mm).
- Ability to go through 90° bends in pipes with a minimum diameter of 1.97" (50mm).
- For health and safety reasons it is strongly recommended to wear rubber gloves when operating the camera.
- Try to keep the push cable away from sharp edges of a pipe as this may cause damage.
- NEVER force the camera through a pipe as this may damage the camera head.
- Always try to run water down the pipe under inspection. This will keep the system clean and allow the camera to be pushed further.
- When the camera has settled in the pipe, adjust the LED lights to a level which provides the best picture.
- It is usually necessary to give a little extra push at changes in direction such as P- traps, Tee's, Y's, Elbows, etc. Pull back the camera head approximately 8" (20cm) from the bend, if necessary, and give it a quick push, "popping" the camera through a turn. Try to be as gentle as possible and do not hammer or snap the camera head through corners.
- Do not try to use the camera head to clear obstructions. This system is a diagnostic tool, not a drain cleaner. Using the camera head to clear obstructions could damage the camera head or cause it to be caught in the pipe.
- If the camera sits in a pipe, or an enclosed environment for long periods of time, heat may buildup. This may lead to the camera head overheating which will cause fuzzy lines to appear on the monitor. In the event this occurs, turn off the system immediately, remove the camera from the pipe and let the camera head cool for 10 to 15 minutes. Running cooler water into the line will also help cool the camera head.
- When the inspection is finished it is recommended to use paper towel or a rag to wipe off the push cable as it is being retrieved.

Features

- Complete video inspection system built in a hard carrying case
- Camera and video functions save high resolution images and records video/audio
- Twelve high visibility LED lights provide illumination in dimly lit environments
- Scratch-resistant sapphire lens and durable stainless steel camera housing
- 65.6ft (20m) cable mounted on cable reel
- High resolution 16:9 7" TFT LCD display
- Video and audio output
- Rechargeable lithium-ion battery and car charger
- Sun visor is included to act as a sun shield for outdoor inspections
- 90° mirror rotation and low battery indicator

Included

- Camera Head
- 20m Cable Reel and Push Cable
- Remote Control
- Hard Carrying Case with built-in DVR
- Battery Pack and Cable
- Car Charger
- Fuse
- 1 x Support Guide, 1.8" (46mm)
- 1 x Support Guide, 3.15" (80mm)
- 2 x Screw
- 2 x Nut
- Waterproof Ring and Adapters
- Screwdriver

Specifications

Camera

Camera Resolution:	800 x 480
Camera Diameter:	0.91" (23mm)
Camera Length:	4.7" (120mm)
Lens/Housing Material:	Sapphire/Stainless Steel
Viewing Distance:	7.9 to 39.4" (20 to 100cm)
Depth of Field:	100cm to infinity
Viewing Angle:	0 to 140°

continued...

General Specifications

Display:	7" Color TFT LCD (16 x 9)
Display Resolution:	800 x 480
Frames per Second (FPS):	30
Standard Gooseneck/Cable Length:	65.6' (20m)
Cable Diameter:	0.2" (5.2mm)
Rotate Display:	Yes (90°)
Playback:	Photo, Video and Audio
Memory:	Internal/SD Card
TV Out:	PAL/NTSC
Data Output:	USB/SD Card
LED Brightness Adjustment:	Yes (12 white LEDs)
Low Battery Indicator:	Yes
Power Supply:	Rechargeable Li-ion Battery, AC Adapter, Car Charger
On-Screen Supported Languages:	English, German, French, Spanish, Italian, Chinese, Japanese, Russian, Portuguese
Product Certifications:	CE, IP67 (Camera Head)
Operating Temperature:	14 to 122°F (-10 to 50°C)
Storage Temperature:	4 to 140°F (-20 to 60°C)
Operating Humidity Range:	30 to 90%
Dimensions:	22.7 x 10.4 x 20.4" (575 x 265 x 520 mm)
Weight:	22lbs (10kg)

Instrument Description

The pipe inspection system includes the following four main parts: camera head, cable reel, battery pack and DVR.

Camera Head

1. Connector
2. Spring
3. LED Lights
4. Sapphire Lens

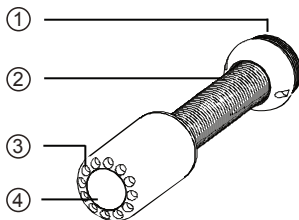

Cable Wheel and Push Cable

1. Rotation Mechanism
2. Cable Wheel
3. Push Cable
4. Cable Connector (to Camera)
5. Handle

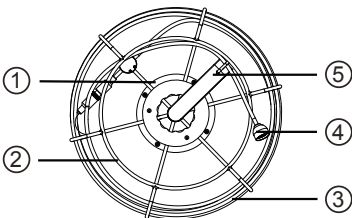

Battery Pack

1. DC 7.4V Output
2. USB Output (DC 5V)
3. DC 12V Recharging
4. Power Button
5. LED (Battery Level Indicator)
6. Fuse

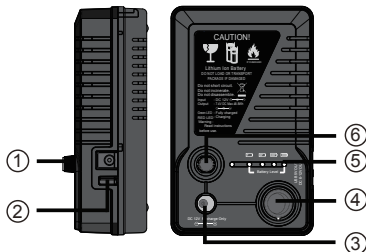

continued...

Remote Control

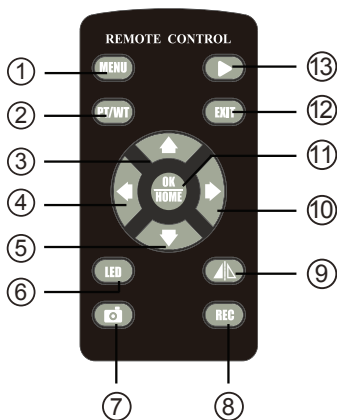

1. Menu Button
2. Pt/Wt: Meter Counter Function (Not Available)
3. Up: Select Up/Previous Item
4. Left: Select Left Item
5. Down: Select Down/Next Item
6. LED: Adjust the LED Brightness
7. Photo: Take Photo
8. REC: Start/Stop Recording
9. Mirror: Mirror And Flip Image
10. Right: Select Right Item
11. OK & Home: Confirm/Select Menu
12. Exit: Exit Menu
13. Playback Button

continued...

DVR and Tool Box Contents Description

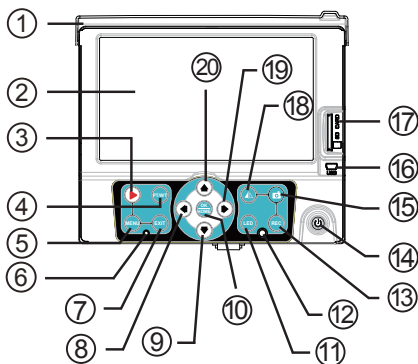

- | | |
|--|------------------------------------|
| 1. Sun Visor | 11. LED: Change the LED Brightness |
| 2. Color TFT LCD Display | 12. IR For Remote Control |
| 3. Playback Mode Button Menu Button | 13. REC: Start/Stop Recording |
| 4. Pt/Wt: Meter Counter Function (Not Available) | 14. Power Switch |
| 5. Menu Button | 15. Photo: Take Photo |
| 6. Power Indicator LED | 16. USB 2.0 to PC |
| 7. Exit Menu Button | 17. SD Card Slot |
| 8. Left Button | 18. Mirror: Mirror and Flip Image |
| 9. Down: Select Down/Next Item | 19. Right: Select Right Item |
| 10. OK & Home: Confirm/Select Menu | 20. Up: Select Up/Previous Item |

continued...

21. Video & Audio Out
22. DC In
23. DC 12V Cable
24. Camera Head Slot
25. Battery Pack & Cable
26. Remote Control Slot
27. Adapter & Car Charger
28. Aviation Electrical Connector

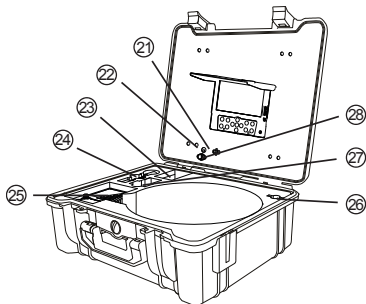

DVR Icon Description

1. Record
2. LED Brightness
3. Timestamp
4. Image Mirror
5. Image Reverse & Mirror
6. Image Reverse
7. Battery Level
8. SD Card

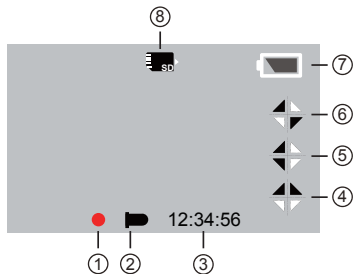

Operating Instructions

Installation

Installing Camera Head

1. Prior to installing the camera, ensure the cable is secured on the hook of the handle.
2. Hold the cable connector in one hand.
3. Grip the guide spring and screw the camera head clockwise until it is tight.
4. Ensure the seal ring and the gold pins are in good condition before installing camera head.

continued...

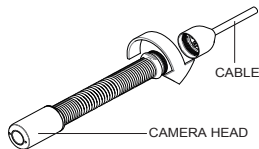
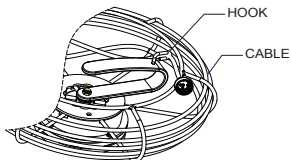

Installing the Support Guide Fitting

Support guides are designed to help position the camera towards the middle of the pipe. Two different size guides are available to meet application requirements.

1. Installing the 1.8" (46mm) Support Guides

With the included screwdriver unscrew the 46mm support guide. Place each part of the guide on either side of the camera head and tighten the screws to fasten the guide.

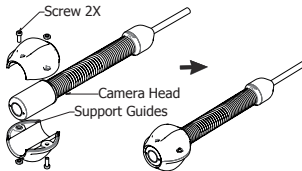

Applicable to 2.5 to 3.5" pipe

2. Installing the 3.15" (80mm) Support Guides

With the included screwdriver unscrew the 80mm support guide. Place each part of the guide on either side of the camera head and tighten the screws to fasten the guide.

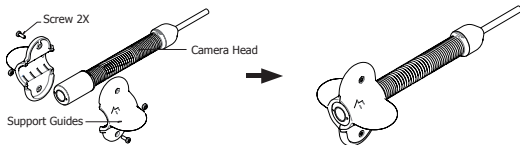

Applicable to 4 to 5" pipe





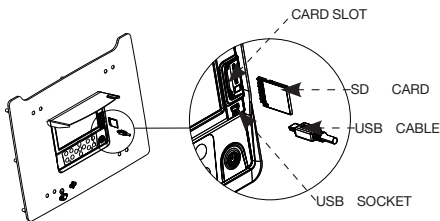

continued...

Installing the SD Card





DVR Function Guide

Live Video

1. Press  to turn on/off. When powered, the DVR will enter the live video mode. Press  to enter playback mode.
2. Press  to start/stop recording.
3. Press  to mirror and/or reverse the image.
4. Press  to adjust the brightness of camera LEDs.
5. Press  to take a picture.

Video Menu Options



1. Press the  button to enter the video menu options.
2. Press the  and  arrows to scroll through the following parameters:

Setting the Video Resolution (Size)
Set Recording Time (Video Seg)
Enabling/Disabling Sound (Sound)
Enabling/Disabling Timestamp (Timestamp)

3. Once the appropriate parameter has been selected by pressing the  button follow the associated instructions below.

continued...



Setting the Video Resolution

1. Press the ▲ and ▼ arrows to select between "HD", "D1 (720*576)", "VGA (640*480)", "QVGA (320*240)".
2. Press the  button to confirm the selection.
3. Press the  button to exit the "Video Menu Options" and resume normal operation.



Set Recording Time

1. Press the ▲ and ▼ arrows to select between 10min, 20min, 30min, 40min of recording time or "OFF".



Note: When enabled, this function prevents oversized files and overwrites older files when SD memory card is full. Set to "OFF" to disable file size restriction and overwriting.

2. Press the  button to confirm the selection.
3. Press the  button to exit the "Video Menu Options" and resume normal operation.

Enabling/Disabling Sound

1. Press the ▲ and ▼ arrows to select between "ON" or "OFF".
2. Press the  button to confirm the selection.
3. Press the  button to exit the "Video Menu Options" and resume normal operation.

Enabling/Disabling Timestamp









1. Press the ▲ and ▼ arrows to select between "Date & Time", "Date only" or "OFF".
2. Press the  button to confirm the selection.
3. Press the  button to exit the "Video Menu Options" and resume normal operation.

continued...

Playback Mode



1. Press the  button to enter playback mode, which allows the user to browse, preview and playback media files.

Note: If there are no files to view, the display will indicate "NO IMAGE". Press the  button to exit.

2. Press the  and  arrows to scroll through media files.
3. Press the  button to confirm the selection.
4. Follow the media controls below to preview the selected media file:
 -  button to Play/Pause media file
 -  button to stop the playback and skip back to the beginning
 -  button to rewind the media file
 -  button to forward the media file
 -  button set speed rate of rewind/forward function of the media file
5. Press the  button to exit the selected media file and return to the "Playback" mode.

Note: At any time, you can press the  button to exit and resume normal operation.

Playback Settings



1. While in playback mode, press the  button to enter the playback settings.
2. Press the  and  arrows to scroll through the following parameters:

Delete	Delete single or all media files
Slide Show	Set interval time of the slide shows ranging from 3sec/5sec/10sec
Protection	Protect important media files
Thumbnail	View 9 media files per page
File List	View 3 media files per page
Volume	Adjust the volume of media files

3. Once the appropriate parameter has been selected by pressing the  button follow the associated instructions below.



continued...

Deleting Media Files

1. Press the ▲ and ▼ arrows to select between deleting a "Single/Current Media File" or "All Media Files".
2. Press the  button to confirm the selection.
3. Press the  button to exit the Playback settings and return to the Playback mode.



Note: At any time, you can press the ► button to exit and resume normal operation.

Setting Interval Time

1. Press the ▲ and ▼ arrows to select between 3sec/5sec/10sec slide show interval times.
2. Press the  button to confirm the selection and view selected media file slide show.
3. Press the  button to exit the Playback settings and return to the Playback mode.

Note: At any time, you can press the ► button to exit and resume normal operation.

Protecting Media Files

1. Press the ▲ and ▼ arrows to select between protecting a "Single/Current Media File" or "All Media Files".
2. Press the  button when selected.
3. Press the  button again to "Set" the media file protection.

Note: Repeat steps 1 to 3 to cancel the protected file(s).

4. Press the  button to exit the Playback settings and return to the Playback mode.

Note: At any time, you can press the ► button to exit and resume normal operation.

Setting Thumbnail Viewer

Pressing the  button while in playback settings executes thumbnail viewer.

Note: At any time, you can press the ► button to exit and resume normal operation.





continued...

File List Viewer

Pressing the  button while in playback settings executes file list viewer.





Note: At any time, you can press the  button to exit and resume normal operation.

Volume Adjustment

1. Press the  and  arrows to adjust the volume of media file(s) ranging from 4 to 6.
2. Press the  button to confirm the selection.
3. Press the  button to exit the Playback settings and return to the Playback mode.

Note: At any time, you can press the  button to exit and resume normal operation.



Setup Mode

1. Press the  button to enter the video menu options.
2. Press the  button to enter setup mode/menu.
3. Press the  and  arrows to scroll through the following parameters:

Format	Format the SD card
LCD	LCD brightness
Language	English, German, French, Spanish, Italian, Chinese, Japanese, Russian, Portuguese
System Reset	Reset all settings
Light Frequency	Setting ambient light frequency, 50/60Hz
TV Output	PAL/NTSC
Date Input	To set date and time of media file

4. Once the appropriate parameter has been selected by pressing the  button follow the associated instructions below.





Formatting the SD card

1. Press the  and  arrows to cancel or execute the SD card formatting.
2. The system will automatically return to the Setup menu when formatting is complete.





continued...

3. Press the  button to exit the "Video Menu Options" and resume normal operation.



Adjusting LCD Brightness

1. Press the  and  arrows to adjust the LCD brightness of media file(s) ranging from 7 to 9 intensity.
2. Press the  button to confirm the selection.
3. Press the  button to exit the "Video Menu Options" and resume normal operation.





Selecting System Language

1. Press the  and  arrows to select the required system language from the default list.
2. Press the  button to confirm the selection.
3. Press the  button to exit the "Video Menu Options" and resume normal operation.





System Reset

1. Press the  and  arrows to cancel or execute the system reset
2. The system will automatically return to the normal operation screen when complete.

Setting Light Frequency



1. Press the  and  arrows to select between 50 or 60Hz light frequency.
2. Press the  button to confirm the selection.
3. Press the  button to exit the "Video Menu Options" and resume normal operation.

Selecting TV Output

1. Press the  and  arrows to select between "NTSC" or "PAL TV" output.
2. Press the  button to confirm the selection.
3. Press the  button to exit the "Video Menu Options" and resume normal operation.

continued...

Enabling/Disabling Date & Time

1. Press the ▲ and ▼ arrows to "Enable (Set)" or "Disable (Off)" media file date & time.
2. Press the  button to confirm the selection.
3. If enabled, press the ▲ and ▼ arrows to display the date as "DD/MM/YYYY", "MM/DD/YYYY" or "YYYY/MM/DD".
4. When selected, press the ◀ and ▶ arrows to scroll through each value and adjust if required.
5. To adjust a specific value press the ▲ and ▼ arrows.
6. Press the  button to confirm the timestamp.
7. Press the  button to exit the "Video Menu Options" and resume normal operation.

Applications

- Sewer and pipe inspection
- Building ducts/HVAC/R inspections
- Well inspections
- Building and home inspection

Accessories and Replacement Parts

R9000-BALL Replacement Ball Guide

R9000-SKID Replacement Skid Guide

R9000-RCH Replacement Camera Head

R9000-CAMT Camera head with 512hz Transmitter

R9000-RCV Receiver, 512hz

R9000-20M Replacement 65.6' (20m) Cable

R9000-40M Extended Length Cable 131.2' (40m)

SD-4GB SD Memory Card, 4GB

RSD-16GB Micro SD Memory Card w/Adapter, 16GB

Don't see your part listed here? For a complete list of all accessories and replacement parts visit your product page on www.reedinstruments.com.

Product Care

To keep your instrument in good working order we recommend the following:

- Store your product in a clean, dry place.
- Change the battery as needed.
- If your instrument isn't being used for a period of one month or longer please remove the battery.
- Clean your product and accessories with biodegradable cleaner. Do not spray the cleaner directly on the instrument. Use on external parts only.

Product Warranty

REED Instruments guarantees this instrument to be free of defects in material or workmanship for a period of one (1) year from date of shipment. During the warranty period, REED Instruments will repair or replace, at no charge, products or parts of a product that proves to be defective because of improper material or workmanship, under normal use and maintenance. REED Instruments total liability is limited to repair or replacement of the product. REED Instruments shall not be liable for damages to goods, property, or persons due to improper use or through attempts to utilize the instrument under conditions which exceed the designed capabilities. In order to begin the warranty service process, please contact us by phone at 1-877-849-2127 or by email at info@reedinstruments.com to discuss the claim and determine the appropriate steps to process the warranty.

Product Disposal and Recycling



Please follow local laws and regulations when disposing or recycling your instrument. Your product contains electronic components and must be disposed of separately from standard waste products.

Product Support

If you have any questions on your product, please contact your authorized REED distributor or REED Instruments Customer Service by phone at 1-877-849-2127 or by email at info@reedinstruments.com.

Please visit www.REEDINSTRUMENTS.com for the most up-to-date manuals, datasheets, product guides and software.

*Product specifications subject to change without notice.
All rights reserved. Any unauthorized copying or reproduction of this manual is strictly prohibited without prior written permission from REED Instruments.*

REED

INSTRUMENTS

TEST & MEASURE WITH CONFIDENCE



CHECK OUT OUR LATEST PRODUCTS!

.800.561.8187

www.**itm**.com

information@itm.com

REED INSTRUMENTS

TEMPERATURE
& HUMIDITY



SOUND



MOISTURE



AIR VELOCITY



ELECTRICAL

