

R4500SD

REED INSTRUMENTS

Data Logging Hot Wire Thermo- Anemometer



Instruction Manual

Table of Contents

Introduction	3
Product Quality.....	3
Safety	4
Features.....	4
Included.....	4
Specifications.....	5-6
Instrument Description	7
Display Description	8
Hot Wire Probe Description.....	9
Operating Instructions.....	9-11
<i>Power ON/OFF</i>	9
<i>Selecting Measurement Modes</i>	9
<i>Air Velocity/Temperature Measurement</i>	9-10
<i>Changing the Air Velocity Unit of Measure</i>	10
<i>Type K/J Thermocouple Measurement Mode</i>	10
<i>Data Hold</i>	11
<i>Recording Maximum and Minimum Readings</i>	11
<i>Backlight</i>	11
Setup Mode.....	12-15
<i>Setting the Time and Date (dAtE)</i>	12
<i>Setting Data Decimal Format (dEC)</i>	13
<i>Enabling/Disabling Auto Power Off (PoFF)</i>	13
<i>Enabling/Disabling the Beeper (bEEP)</i>	13
<i>Selecting Thermocouple Type (tYPE)</i>	14
<i>Selecting the Temperature Unit of Measure (t-CF)</i>	14
<i>Setting the Data Logging Sampling Rate (SP-t)</i>	14
<i>Formatting the SD Card (Sd F)</i>	14-15
<i>Verify Set Time and Date</i>	15
<i>Verify Sampling Rate</i>	15

continued...

Data Logging	15-17
<i>Data Recording Modes</i>	15
<i>Manual Data Logging Mode</i>	15-16
<i>Automatic Data Logging Mode</i>	16
<i>Transferring Data from the SD Memory Card to a Computer</i>	16-17
Data Stream Output	17-18
<i>3.5mm Terminal to RS-232 Serial Connection</i>	18
System Reset	18
Battery Replacement.....	19
Applications.....	19
Accessories and Replacement Parts	19-20
Frequently Asked Questions (FAQ's).....	20
Product Care	20
Product Warranty	21
Product Disposal and Recycling	21
Product Support.....	21

Introduction

Thank you for purchasing your REED R4500SD Data Logging Hot Wire Thermo-Anemometer. Please read the following instructions carefully before using your instrument. By following the steps outlined in this manual your meter will provide years of reliable service.

Product Quality

This product has been manufactured in an ISO9001 facility and has been calibrated during the manufacturing process to meet the stated product specifications. If a certificate of calibration is required please contact the nearest authorized REED distributor or authorized Service Center. Please note an additional fee for this service will apply.

Safety

Never attempt to repair or modify your instrument. Dismantling your product, other than for the purpose of replacing batteries, may cause damage that will not be covered under the manufacturer's warranty. Servicing should only be provided by an authorized service center.

Features

- Measures air velocity (fpm, m/s, kph, mph and knots) and air temperature
- Contact temperature measurement with type J/K thermocouple option
- Thermistor sensor for fast air temperature readings
- Hot wire probe for precise low air velocity measurements
- Real-time data logger with integrated SD memory card
- User selectable sampling rate from 1 to 3600 seconds
- Easy-to-read backlit LCD display
- Data hold and Min/Max functions
- Tripod mount for long-term monitoring
- Low battery indicator and auto shut off

Included

- Telescope Hot Wire Probe
- Hard Carrying Case
- Batteries

Specifications

Type:	Hot Wire
Measuring Ranges:	fpm: 40 to 4921 m/s: 0.2 to 25 km/h: 0.7 to 90 mph: 0.5 to 55.9 knots: 0.4 to 48.6
Air Temperature:	32 to 122°F (0 to 50°C)
Type K Temperature:	-148 to 2372°F (-100 to 1300°C)
Type J Temperature:	-148 to 2192°F (-100 to 1200°C)
Accuracy:	Air Velocity: $\pm(5\% \text{ rdg} + 20 \text{ fpm},$ 0.2 m/s, 0.3 km/h, 0.2 mph, 0.2 knot) Air Temperature: $\pm 1.5^\circ\text{F}$ (0.8°C) Contact Temperature: $\geq -58^\circ\text{F}$ (-50°C) $\pm(0.4\% + 1^\circ\text{F}$ (0.5°C)) $\leq -58^\circ\text{F}$ (-50°C) $\pm(0.4\% + 1.8^\circ\text{F}$ (1°C))
Resolution:	fpm: 1 m/s, km/h, mph, knot: 0.1
Temperature:	0.1°F/°C
Telescope Probe Length:	11 to 37" (280 to 940mm)
Response Time:	<1 second
Display:	5-digit, Dual LCD Display
Backlit Display:	Yes
Data Hold:	Yes
Min:	Yes
Max:	Yes
Datalogging Capabilities:	Yes
Real-Time Clock and Date Stamp:	Yes
Sampling Rate:	Yes (1, 2, 5, 10, 30, 60, 120, 300, 600, 1800, 3600 seconds)

continued...

REED

External Memory:	Yes, expandable up to 16GB with SD card (optional)
Auto Shut-off:	Yes (after 10 minutes/off)
Kick Stand:	Yes
Tripod Mountable:	Yes
Low Battery Indicator:	Yes
Power Supply:	6 x AA batteries or AC Adapter (optional)
Data Output:	Yes (RS-232)
Product Certifications:	CE
Operating Temperature:	32 to 122°F (0 to 50°C)
Storage Temperature:	14 to 140°F (-10 to 60°C)
Operating Humidity Range:	10 to 80%
Dimensions:	8 x 3 x 1.5" (203 x 76 x 38mm)
Weight:	1.13lbs (515g)

Instrument Description

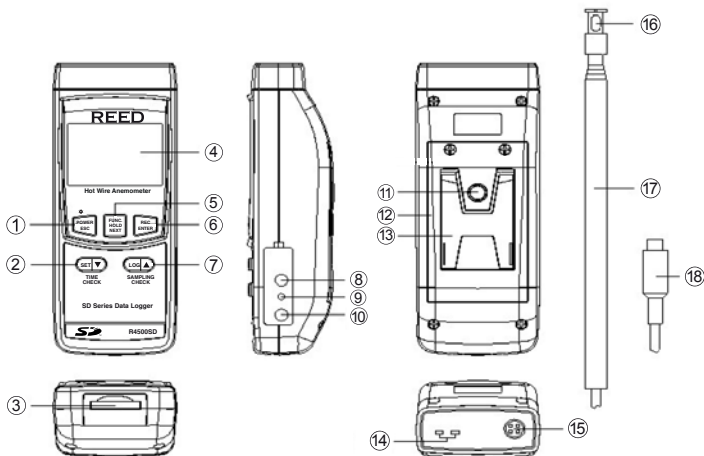

- | | |
|------------------------------------|---|
| 1. POWER/Backlight/ESC Button | 10. Power Adapter Input |
| 2. SET/Down/Time Button | 11. Tripod Mounting Screw |
| 3. SD Card Slot | 12. Battery Cover |
| 4. LCD Display | 13. Kickstand |
| 5. HOLD/FUNCTION/
NEXT Button | 14. Type K/J Thermocouple
Input Jack |
| 6. REC/ENTER Button | 15. Telescopic Probe Input Socket |
| 7. LOG/Up/Sampling
Check Button | 16. Telescopic Probe Sensing Head |
| 8. RS-232 Output Jack | 17. Telescopic Probe Handle |
| 9. Reset Pin | 18. Telescopic Probe Plug |

Display Description

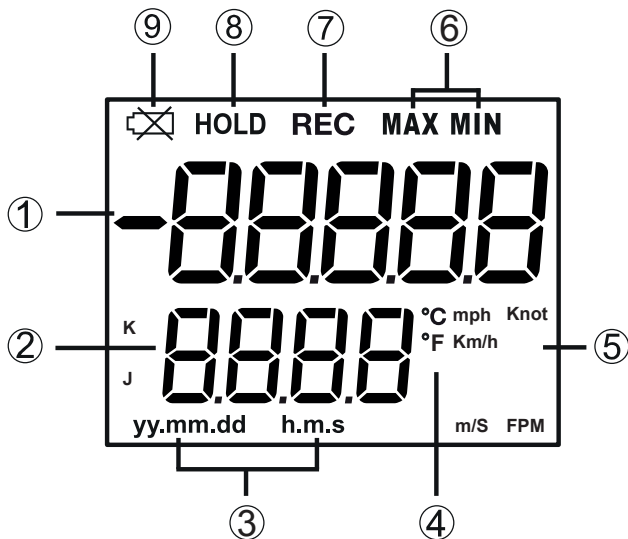

1. Measurement Reading Indicator
2. Date & Time Values/Measurement Modes Indicator
3. Date/Time Stamp
4. Temperature Unit of Measure
5. Unit of Measure
6. Maximum and Minimum Indicators
7. Record Mode Indicator
8. Data Hold Indicator
9. Low Battery Indicator

Hot Wire Probe Description

1. Wind Direction Marker
2. Air Velocity Sensor
3. Protective Cover in the Open position
4. Protective Cover in the Closed position
5. Temperature Sensor

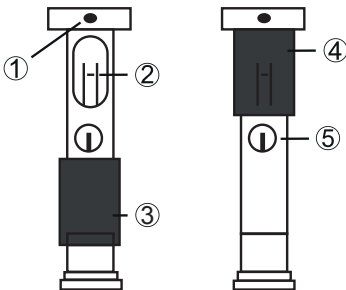

Operating Instructions

Power ON/OFF

Turn the meter on by pressing the **POWER** button. To turn the meter off, press and hold the **POWER** button for 2 seconds.

Note: This meter can be powered by either six (6) "AA" batteries or AC adapter (sold separately).

Selecting Measurement Modes

The R4500SD offers 2 types of measurement modes:

- Air Velocity/Temperature measurement
 - Type K/J Thermometer measurement
1. When the meter is on, press and hold the **FUNCTION** button to toggle between "An" for air velocity/temperature and "tP" for Type K/J Thermometer measurement modes of operation.
 2. Release the **FUNCTION** button to confirm selection.

Air Velocity/Temperature Measurement

When the Telescopic Probe is not in use, slide the Sensor Cover over the Sensor Head. Before using the Telescopic Probe, slide the Sensor Cover down.

continued...

Note: Avoid touching the sensor with your fingers or with any tools, as this may cause damage or incorrect readings.

1. Plug the Telescopic Probe into the Probe Input Socket while the meter is off.
2. Once the meter is powered up, select "Air" function (see *Selecting Measurement Modes* for details).
3. Hold the Probe Handle and face the wind direction mark on the sensor head towards the direction of the airflow. The top part of the display will indicate the air velocity, and the lower part of the display will indicate the air temperature value.

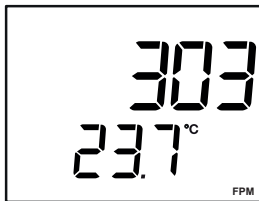

Changing the Air Velocity Unit of Measure

To change the air velocity unit of measure, press and hold the **ENTER** button. The display will scroll through each unit (m/S, Km/h, mph, Knot, & FPM). Release the **ENTER** button to select the displayed unit. The selected unit will be saved as the new default unit of measure.

Type K/J Thermocouple Measurement Mode

1. Select the "tP" function (see *Selecting Measurement Modes* for details).
2. Plug the optional Type K or J Thermocouple Probe into the Type K/J thermocouple input jack.

Note: Make sure to remove the telescopic probe before inserting the thermocouple probe.

3. The screen will display a "K", confirming that is configured by default to a Type K thermocouple probe. The measured temperature will now be displayed on the display screen.

Note: If using a type J thermocouple probe, see *Selecting Thermocouple Type* for details.



continued...

Data Hold

1. While taking a measurement, press the **HOLD** button to freeze the current readings on the display.
2. While in this mode a "HOLD" symbol will appear.
3. Press the **HOLD** button again to resume normal operation.

Note: When the Data Hold feature is active all buttons except the **POWER** button are disabled.

Recording Maximum and Minimum Readings

1. Press the **REC** button to enter recording mode as indicated by "REC" on the LCD. The meter will now begin recording maximum and minimum readings.
2. While in recording mode;
 - A) Press the **REC** button once and the maximum value will appear on the display as indicated by "REC MAX".
 - B) Press the **REC** button again and the minimum value will appear on the display as indicated by "REC MIN".
 - C) To exit recording mode and resume normal operation, press and hold the **REC** button for two seconds.

When in recording mode the **POWER** button is disabled and the meter cannot be turned off.

Backlight

After powering the meter ON, the LCD Backlight will turn on automatically. Press the BACKLIGHT button to turn the LCD Backlight on or off.

Setup Mode

1. Press and hold the **SET** button for 2 seconds to enter Setup Mode.
2. Press the **NEXT** button continuously to scroll through the following parameters.

Parameter	Description
dAtE	Set the time and date
dEC	Set the decimal format (USA (20.00) or European (20,00))
PoFF	Enable or disable the auto-power off function
bEEP	Turn the beeper on or off
tYPE	Select thermocouple type (K or J)
t-CF	Select the temperature unit of measure (°C or °F)
SP-t	Set the data logging sampling rate
Sd F	Format the SD memory card

3. Once the appropriate parameter has been selected, follow the instructions below.

Note: The meter will automatically exit out of the Setup mode if no key is pressed within 7 seconds.

Setting the Time and Date (dAtE)

1. Press the **ENTER** button when "dAtE" appears on the LCD.
2. Press the **▲** and **▼** buttons to adjust the year as indicated by "YY."
3. Press the **ENTER** button to confirm selection.
4. Repeat steps 1 and 2 for month, day, hour, minute and seconds as indicated by (mm/dd/h/m/s).
5. After each value has been selected and confirmed, it will automatically skip to the next parameter.

Note: At any time, you can press the **ESC** button to exit the Setup mode and resume normal operation. The internal clock will keep accurate time when the meter is powered off. When new batteries are installed the clock will have to be reset.

continued...

Setting Data Decimal Format (dEC)

Numeric formats vary in different countries. By default the meter is set to bASIC mode where a decimal point is used to separate units, (i.e. 20.00). The European format uses a comma (i.e. 20,00) to separate units. To change this setting, follow steps 1 and 2 when the "dEC" parameter appears on the LCD.

1. Press the ▲ and ▼ buttons to select between bASIC and Euro.
2. Press the **ENTER** button to confirm selection and skip to next parameter.

Note: At any time, you can press the **ESC** button to exit the Setup mode and resume normal operation.

Enabling/Disabling Auto Power Off (PoFF)

Follow steps 1 and 2 when "PoFF" appears on the LCD.

1. Press the ▲ and ▼ buttons to select between YES (enabled) or NO (disabled). With the Auto Power OFF feature enabled, the meter will automatically switch OFF after 10 minutes of inactivity to preserve battery life.
2. Press the **ENTER** button to confirm selection and skip to next parameter.

Note: At any time, you can press the **ESC** button to exit the Setup mode and resume normal operation.

Enabling/Disabling the Beeper (bEEP)

Follow steps 1 and 2 when "bEEP" appears on the LCD.

1. Press the ▲ and ▼ buttons to select between ON (enabled) or OFF (disabled).
2. Press the **ENTER** button to confirm selection and skip to next parameter.

Note: At any time, you can press the **ESC** button to exit the Setup mode and resume normal operation.

continued...

Selecting Thermocouple Type (tYPE)

Follow steps 1 and 2 when "tYPE" appears on the LCD.

1. Press the ▲ and ▼ buttons to select between type K and J.
2. Press the **ENTER** button to confirm selection and skip to next parameter.

Note: At any time, you can press the **ESC** button to exit the Setup mode and resume normal operation.

Selecting the Temperature Unit of Measure (t-CF)

Follow steps 1 and 2 when "t-CF" appears on the LCD.

1. Press the ▲ and ▼ buttons to select between °C and °F.
2. Press the **ENTER** button to confirm selection and skip to next parameter.

Note: At any time, you can press the **ESC** button to exit the Setup mode and resume normal operation.

Setting the Data Logging Sampling Rate (SP-t)

Follow steps 1 and 2 when "SP-t" appears on the LCD.

1. Press the ▲ and ▼ buttons to adjust the sampling rate between 0, 1, 2, 5, 10, 30, 60, 120, 300, 600, 1800, and 3600 seconds.
2. Press the **ENTER** button to confirm selection and skip to next parameter.

Note: At any time, you can press the **ESC** button to exit the Setup mode and resume normal operation.

Formatting the SD Card (Sd F)

Follow steps 1 through 5 when "Sd F" appears on the LCD.

1. Press the ▲ and ▼ buttons to select "YES" to format the card. Select "NO" to abort.
2. Press the **ENTER** button to confirm selection.
3. Press the **ENTER** button again to re-confirm.
4. The meter will format the SD card and automatically return to the Setup menu when formatting is complete.
5. Press the **ESC** button to exit the Setup mode and resume normal operation.

Note: It is recommended that new SD cards should be formatted prior to first use. If the formatting process fails, the meter will display -E-.

continued...

Verify Set Time and Date

During normal operation press the TIME CHECK button to display the year, month, day, hour and minutes.

Verify Sampling Rate

During normal operation, press the SAMPLING CHECK button to view the selected sampling rate.

Data Logging

Data Recording Modes

Manual Data Logging: Press the **LOG** button to manually log up to 99 readings on a SD memory card (see *Manual Data Logging Mode* for details).

Automatic Data Logging: Setup the meter parameters in order to automatically log data on a SD memory card. The number of data points is limited by the size of the memory card.

Note: It is recommended to use a class 4 SDHC memory card between 1 and 16Gb. Insert the SD memory card in the slot at the bottom of the meter. The card must be inserted with the label side facing the rear of the meter.

Manual Data Logging Mode

In manual mode, the **LOG** button is pressed to manually log a reading on the inserted SD card at any time. In order to setup the meter for manual data logging, follow steps 1 through 8 below.

1. Set the data logging sampling rate to "0" seconds (see *Setting the Data Logging Sampling Rate* section for details).
2. Press the **REC** button and "REC" will appear on the LCD.
3. The meter will also display P-X (X = memory position number between 1 and 99).
4. Press the **SET** button to enter the data memory positions selection.
5. Press the **▲** and **▼** buttons to select one of the 99 data memory positions in which to record.
6. Press the **ENTER** button to confirm selection.

continued...

7. Press the **LOG** button to save a reading to memory.

Note: If a card is not inserted or the card is defective, the meter will flash "CArD -E-". In this case, power the meter OFF and try again with another SD memory card or verify that the card is correctly inserted.

8. To exit manual data logging mode, press and hold the **REC** button 2 seconds to resume normal operation.

Automatic Data Logging Mode

In automatic mode the desired data logging sampling rate is set to 1, 2, 5, 10, 30, 60, 120, 300, 600, 1800 or 3600 seconds prior to recording (see *Setting the Data Logging Sampling Rate* section for details). In order to setup the meter for automatic data logging, follow steps 1 through 5 below.

1. To begin a data logging session, press the **REC** button and "REC" will appear on the LCD.

2. Press the **LOG** button. The meter will scan for a SD memory card.

Note: If a card is not inserted or the card is defective, the meter will flash "CArD -E-" indefinitely. In this case, power the meter OFF and try again with another SD memory card or verify that the card is correctly inserted.

3. The "REC" icon will appear on the LCD and will continuously flash while in a data logging session.

4. To pause the data logging session press the **LOG** button and "REC" will stop flashing. To resume press the **LOG** button again.

5. To end the current data logging session pause the data logging session and hold the **REC** button until "REC" disappears.

Transferring Data from the SD Memory Card to a Computer

1. While the meter is powered Off remove the SD memory card from the SD card slot.

2. Insert the SD memory card into the computer.

continued...

3. Open the file(s) with Excel. See sample below:

Place	Date	Time	Value	Unit	Value	Unit
1	19-07-10	8:14:05	0.6	m/S	21.6	AMTemp C
2	19-07-10	8:14:08	0.5	m/S	21.6	AMTemp C
3	19-07-10	8:14:10	15	m/S	27	AMTemp C
4	19-07-10	8:14:12	0.4	m/S	21.6	AMTemp C
5	19-07-10	8:14:14	0.4	m/S	21.6	AMTemp C
6	19-07-10	8:14:16	10	m/S	30	AMTemp C
7	19-07-10	8:14:18	0.3	m/S	21.6	AMTemp C
8	19-07-10	8:14:20	0.1	m/S	21.6	AMTemp C
9	19-07-10	8:14:22	13	m/S	25	AMTemp C
10	19-07-10	8:14:24	1.1	m/S	21.4	AMTemp C
11	19-07-10	8:14:26	2.8	m/S	21.3	AMTemp C
12	19-07-10	8:14:28	3.7	m/S	21.3	AMTemp C

The raw data can be used to create a graph in Excel. See sample below:

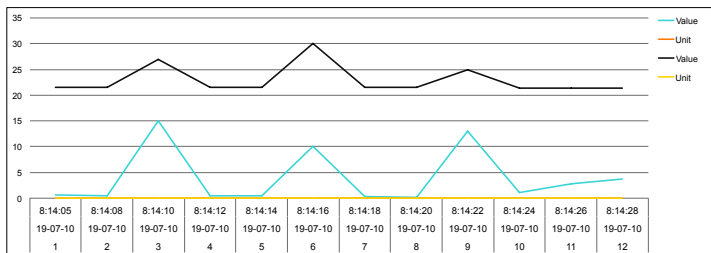

Data Stream Output

Using Terminal application, a data stream can be viewed from the RS-232 output, connect RS-232/USB cable between the product and terminal/PC and use the following setting to view the data stream.

Terminal Settings:

- Bits per second: 9600
- Data bits: 8
- Parity: None
- Stop bits: 1

continued...

41080100000035 = Upper Value, 3.5 m/s

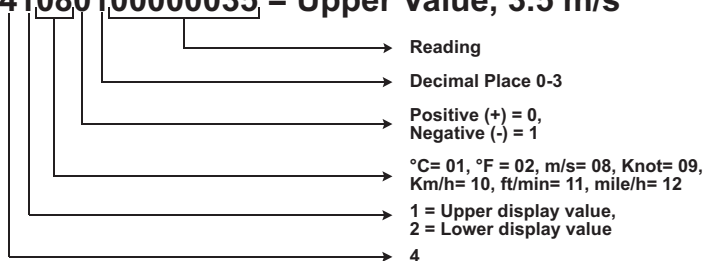

3.5mm Terminal to RS-232 Serial Connection

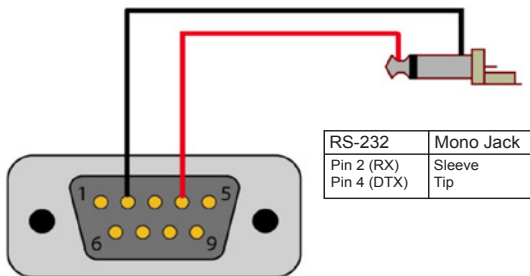

System Reset

If the meter becomes unresponsive or if the display freezes, the Reset pin can be used to reset the instrument.

1. Use a paper clip or any similar small object to press the Reset pin.
2. After pressing the Reset pin, power the meter back up by holding the **POWER** button for 2 seconds.
3. If resetting the meter does not resolve the issue, please return the meter to the nearest authorized REED distributor or authorized Service Center for repair.

Battery Replacement

When the low battery icon  appears on the LCD, the batteries must be replaced.

1. Remove the two (2) Phillips screws on the back of the meter directly located above the top of the kickstand.
2. Remove the battery cover.
3. Replace 6 x "AA" batteries.
4. Secure the battery cover with the two (2) Phillips screws.

Applications

- HVAC/R and Refrigeration Servicing
- Detecting Filter Blockage
- Condensers and Chillers

Accessories and Replacement Parts

R4500SD-PROBE Replacement Probe for R4500SD

R2920 Surface Thermocouple Probe

R2930 Right Angle Thermocouple Probe

R2940 Air/Gas Thermocouple Probe

R2950 Immersion Thermocouple Probe

R2960 Needle Tip Thermocouple Probe

TP-01 Beaded Thermocouple

R1500 Tripod

RSD-ADP-NA Power Supply, 110V

RSD-ADP-EU Power Supply, 220V

CA-05A Soft Carrying Case

R8888 Deluxe Hard Carrying Case

SD-4GB 4GB Class 4 SDHC Memory Card

RSD-16GB 16GB Micro SD Memory Card w/ Adapter

Don't see your part listed here? For a complete list of all accessories and replacement parts visit your product page on www.REEDInstruments.com.

REED

Frequently Asked Questions (FAQ's)

I cannot turn off my meter, do you know why?

Often times, the meter cannot be turned off because it is in recording mode ("REC" mode). Make sure to exit that function by holding down the **REC** button before attempting to turn the meter off.

How long can I record for?

Battery life will depend on a number of factors:

- Quality of Battery
- Whether the beeper is ON or OFF
- Whether the backlight is ON or OFF
- Environmental Conditions during data logging

As a reference, using alkaline batteries with both the backlight and beeper on while automatic data logging at a 2 second sampling rate; the batteries lasted approx. 14 hours.

Product Care

To keep your instrument in good working order we recommend the following:

- Store your product in a clean, dry place.
- Change the battery as needed.
- If your instrument isn't being used for a period of one month or longer please remove the battery.
- Clean your product and accessories with biodegradable cleaner. Do not spray the cleaner directly on the instrument. Use on external parts only.

Product Warranty

REED Instruments guarantees this instrument to be free of defects in material or workmanship for a period of one (1) year from date of shipment. During the warranty period, REED Instruments will repair or replace, at no charge, products or parts of a product that proves to be defective because of improper material or workmanship, under normal use and maintenance. REED Instruments total liability is limited to repair or replacement of the product. REED Instruments shall not be liable for damages to goods, property, or persons due to improper use or through attempts to utilize the instrument under conditions which exceed the designed capabilities. In order to begin the warranty service process, please contact us by phone at 1-877-849-2127 or by email at info@REEDInstruments.com to discuss the claim and determine the appropriate steps to process the warranty.

Product Disposal and Recycling



Please follow local laws and regulations when disposing or recycling your instrument. Your product contains electronic components and must be disposed of separately from standard waste products.

Product Support

If you have any questions on your product, please contact your authorized REED distributor or REED Instruments Customer Service by phone at 1-877-849-2127 or by email at info@REEDInstruments.com.

Please visit www.REEDInstruments.com for the most up-to-date manuals, datasheets, product guides and software.

*Product specifications subject to change without notice.
All rights reserved. Any unauthorized copying or reproduction of this manual is strictly prohibited without prior written permission from REED Instruments.*

REED INSTRUMENTS

TEST & MEASURE WITH CONFIDENCE



Access our
Product Catalog

Over 200 portable test and
measurement instruments

