

R2165

REED INSTRUMENTS

Thermal Imaging Camera



Instruction Manual

Table of Contents

Introduction	3
Product Quality.....	3
Safety	3-4
Features.....	4
Included.....	5
Specifications	5-6
Instrument Description	7
Display Description	8
Emissivity.....	9
Software Installation.....	10
Operating Instructions.....	10-19
<i>Power ON/OFF</i>	10
<i>Main Menu</i>	10-13
<i>Enable/Disable Center Point, High/Low Temperature Spots or Region of Interest (ROI)</i>	11
<i>Color Palette Selection</i>	11-12
<i>Enable/Disable Temperature Points</i>	12-13
<i>Select Image Mode</i>	13
<i>Advanced Settings Menu</i>	14-19
<i>Setting the Language</i>	14
<i>Setting the Date and Date Format</i>	14
<i>Switching the Unit of Measure (°F/°C)</i>	15
<i>Setting the High/Low Alarm Values</i>	15
<i>Adjusting Emissivity</i>	16
<i>Setting the LCD Brightness</i>	16
<i>Enabling/Disabling Auto Power OFF</i>	16-17
<i>Changing USB Mode</i>	17
<i>Enable/Disable Auto Save</i>	17
<i>System Settings</i>	18
<i>Device Information</i>	18
<i>Factory Reset</i>	18
<i>Formatting the SD Card</i>	19
Turning the LED Flashlight ON/OFF	19

continued...

Saving, Viewing & Deleting Images	19
Charging the Battery	20
Applications.....	20
Accessories and Replacement Parts	21
Product Care	21
Product Warranty	21
Product Disposal and Recycling	21
Product Support.....	22

Introduction

Thank you for purchasing your REED R2165 Thermal Imaging Camera. Please read the following instructions carefully before using your instrument. By following the steps outlined in this manual your meter will provide years of reliable service.

Product Quality

This product has been manufactured in an ISO9001 facility and has been calibrated during the manufacturing process to meet the stated product specifications. If a certificate of calibration is required please contact the nearest authorized REED distributor or authorized Service Center. Please note an additional fee for this service will apply.

Safety

- Never attempt to repair or modify your instrument. Dismantling your product, other than for the purpose of replacing batteries, may cause damage that will not be covered under the manufacturer's warranty. Servicing should only be provided by an authorized service center.
- Do not point the thermal imager (with or without the lens cover) at intensive energy sources as this can damage the thermal imager.
- Do not use the thermal imager in a temperature higher than 122°F (50°C).
- Always charge the battery between 32 to 122°F (0 to 50°C).
- Clean the case with a damp cloth and a diluted soap solution.
- Do not use abrasives, isopropyl alcohol, or solvents to clean the instrument, lens or screen.

continued...

- Do not clean the infrared lens too vigorously, this can damage the anti-reflective coating.
- Store the thermal imager in cool and dry environment.
- Please use the correct emissivity to obtain accurate temperature measurements.
- To ensure accuracy, please let the instrument warm up for 10 minutes before taking a measurement if it has not been used for a long time.
- When being charged, the internal temperature of the product will rise, which will lead to inaccurate temperature measurement, it is not recommended to take measurements during or right after charging the instrument.

Features

- 160 x 120 infrared resolution (19,200 pixels)
- 2.8" color TFT Display
- Built-in LED flashlight
- Choice of 7 color palettes
- Intuitive on-screen measurement tools
- 3 image modes (Thermal, Visual Image, Thermal Blending)
- High and Low temperature spot and alarm indicators
- IP65 and 6.5' (2m) drop tested
- Rechargeable li-ion battery
- Tripod mountable for continuous long-term monitoring
- View, analyze stored data and generate reports or project in real-time
- Low battery indication and auto shut-off

Included

- Thermal Imaging Camera
- USB Cable
- 32GB Micro SD Card
- Soft Carrying Case

Specifications

Imaging and Optical Specifications

Field of View (FOV):	56 x 42°
Optimal Focal Distance:	0.25m (0.82')
Spatial Resolution:	(IFOV) 6.1 mrad
Thermal Sensitivity (NETD):	<0.05°C (50mK)
Image Capture Frequency:	9Hz
Focus:	Fixed

Measurement

Temperature Range:	14 to 752°F (-10 to 400°C)
Accuracy:	±3.6°F (2°C) or ±2% of reading, for ambient temperature at 77°F (25°C)
Resolution:	0.1°F/°C

Detector Specifications

Detector Type:	Uncooled microbolometer, Focal plane array (UFPA)
Spectral Range:	8 to 14µm
IR Resolution:	160 x 120 (19,200 pixels)

Image Presentation and Measurement Analysis

Display:	2.8" color TFT
Color Palettes:	7 (Ironbow/Rainbow/Rainbow(HC)/ Lava/Red-Hot/White-Hot/Black-Hot)
Image Modes:	Thermal, Visual Image, Thermal Blending
On-Screen Temperature Markers:	7 (Center / High Temp / Low Temp / Region of Interest / Up to 3 points)
Center Spot:	Yes

continued...

Emissivity:	Adjustable (0.01 to 0.99)
Temperature Alarm Indicators:	High/Low (User adjustable)
Automatic Hot/Cold Detection:	Auto hot or cold spot-meter markers

General Specifications

Digital Camera:	Yes
Digital Camera Resolution:	640 x 480 pixels
Display Resolution:	320 x 240 pixels
Image Format:	BMP
LED Flashlight:	Yes
External Memory:	Micro SD card
Auto Shut-off:	Yes (user adjustable 5/10/30 minutes)
Tripod Mountable:	Yes
Low Battery Indicator:	Yes
Power Supply:	3.7V/5000mAh rechargeable Li-ion battery
Battery Life:	Approx. 6 hours
Charging System:	In Camera
Charge Time:	4 hours
PC Connectivity:	USB Cable (Type-C)
Software:	Yes (download from website)
Software Functionality:	Image Analysis / Report Generation / Live Camera Feed
Software OS Compatibility:	Windows 7/8/10/11
Supported Languages:	English and French
Product Certifications:	CE, IP65, 6.5' (2m) drop test
Operating Temperature:	32 to 122°F (0 to 50°C)
Storage Temperature:	-4 to 140°F (-20 to 60°C)
Operating/Storage Humidity Range:	10 to 90%
Maximum Operating Altitude:	6561' (2000m)
Dimensions:	9.3 x 3 x 3.4" (236 x 76 x 86mm)
Weight:	1lbs (454g)

Instrument Description

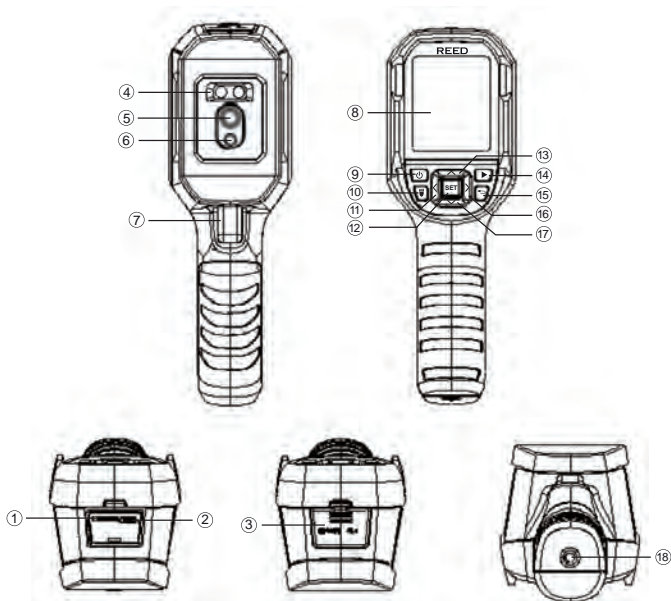

- | | |
|-----------------------------|--------------------------|
| 1. Micro SD Card Slot | 10. Flashlight button |
| 2. USB Interface | 11. Left button |
| 3. Interface Cover | 12. Down button |
| 4. LED Lights | 13. Up button |
| 5. Infrared camera lens | 14. Replay button |
| 6. Visual light camera lens | 15. Right button |
| 7. Trigger | 16. Back button |
| 8. LCD display | 17. SET button |
| 9. Power button | 18. Tripod mounting hole |

Display Description

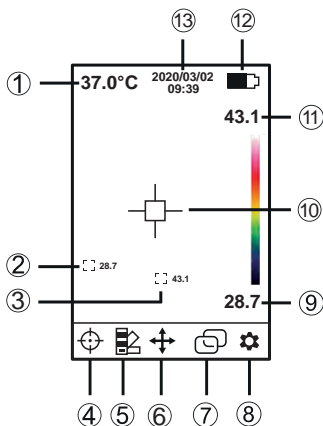

- | | |
|--------------------------------|------------------------------|
| 1. Center Spot Temperature | 8. Advanced Menu Settings |
| 2. Minimum Spot Temperature | 9. Minimum Spot Temperature |
| 3. Maximum Spot Temperature | 10. Center Spot |
| 4. Center Spot Menu Settings | 11. Maximum Spot Temperature |
| 5. Color Palette Menu Settings | 12. Battery Status Indicator |
| 6. Spot Menu Settings | 13. Date & Time |
| 7. Image Mode Menu Settings | |

Emissivity

This thermal imager measures infrared energy from the surface of the object and uses this data to calculate an estimated temperature value. Surfaces that are good at radiating energy (high emissivity), the emissivity factor is ≥ 0.90 . Shiny surfaces or unpainted metals are not good at radiating energy (low emissivity) have an emissivity of < 0.6 . To more accurately measure materials with a low emissivity, an emissivity correction is necessary. Emissivity is set directly as a value or from a list of emissivity values for some common materials.

The following table gives typical emissivity of some materials:

Material	Emissivity	Material	Emissivity
Asphalt	0.95	Drywall	0.95
Concrete	0.95	Render	0.94
Hard plaster	0.90	Smoothing cement	0.90
Wood (natural)	0.93	Lacquer	0.92
Lime Stone	0.98	Latex paint	0.97
Ballast chipping	0.95	Wallpaper	0.93
Paper (every color)	0.95	Tiling	0.93
Plastics non film	0.95	Parquet floor	0.90
Tissue (fabric)	0.95	Laminate	0.90
Sand	0.90	PVC-Floor	0.92
Glass wool	0.90	Brick	0.93
Melted asphalt	0.93	Cliff	0.97
Screed/pavement	0.93	Roofing cardboard	0.93
Foamed polystyrene	0.94	Stucco	0.91

Software Installation

Visit www.REEDInstruments.com/software to download the R2165 software.

Full specifications and Operating System compatibility can be found on the product page at www.REEDInstruments.com.

If you have specific questions related to your application and/or questions related to software setup and functionality please contact the nearest authorized distributor or Customer Service at info@reedinstruments.com or 1-877-849-2127.

Operating Instructions

Power ON/OFF





Press and hold the POWER button for 3 seconds to power on.

Main Menu

1. Press the **SET** button to enter the main menu.





2. Use the  and  buttons to scroll through the list of parameters.

	Enable/Disable Center Point, High/Low Temperature Spots or Region of Interest (ROI)
	Select Color Palette
	Enable/Disable Temperature Points
	Select Image Mode
	Advanced Settings Menu

3. Follow the instructions below to adjust each parameter.

continued...

Enable/Disable Center Point, High/Low Temperature Spots or Region of Interest (ROI)

1. Press the **SET** button when  is highlighted to access the sub-menu.
2. Use the  and  buttons to toggle between the options and press the **SET** button to enable/disable the following features:

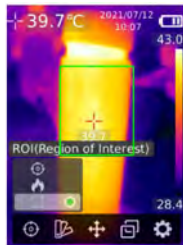









Fig. 1

	Display Center Spot Temperature (when enabled the Center Spot temperature will appear in the top left corner of the screen)
	Display Hi/Lo Spot Temperatures
<input type="checkbox"/>	Display Region of Interest (Fig. 1)

3. Press the  button to confirm selection and return to the main menu.
4. Press the  button again to exit the main menu and resume normal operation.

Color Palette Selection

1. Press the **SET** button when  is highlighted to access the sub-menu.
2. Use the  and  buttons to scroll through the list of color palettes (Fig. 2).
3. Press the **SET** button to select the desired color palette between
Iron (Fig. 3)
Rainbow (Fig. 4)
White Hot (Fig. 5)
Red Hot (Fig. 6)
Black Hot (Fig. 7)
Lava (Fig. 8)
Rainbow HC (Fig. 9).

continued...

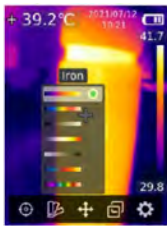

Fig. 2

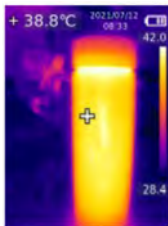

Fig. 3

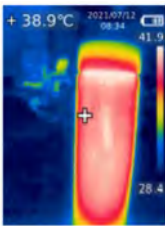

Fig. 4



Fig. 5

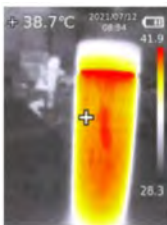

Fig. 6



Fig. 7

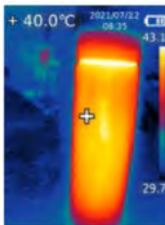

Fig. 8

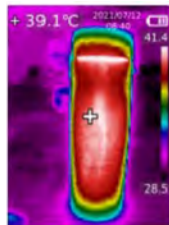









Fig. 9

4. Press the  button to exit the main menu and resume normal operation.

Enable/Disable Temperature Points

1. Press the **SET** button when is  highlighted to access the sub-menu.
2. Use the  and  buttons to toggle through the list of temperature points (Fig. 10).
3. Press the **SET** button to enable or disable the selected temperature point.
4. When enable, the meter will exit the main menu and resume normal operation.
5. Press the     buttons to move the temperature point to the desired area (Fig. 11).

continued...

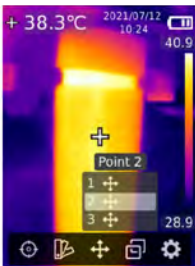

Fig. 10

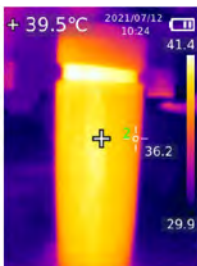





Fig. 11

6. Repeat steps 1 through 5 to enable up to a total of 3 temperature points.
7. When disabling any active temperature point, press the  button twice to exit the main menu and resume normal operation.

Select Image Mode

1. Press the **SET** button when  is highlighted to access the sub-menu.
2. Use the  and  buttons to toggle through the list of image modes.
3. Press the **SET** button to select the desired image mode between Thermal (Infrared Image) (Fig. 12), Digital (Visual Light Image) (Fig. 13), and Fusion (Image Blending) (Fig. 14).

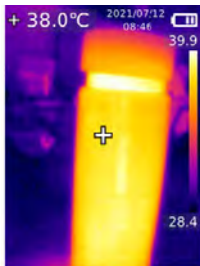

Fig. 12



Fig. 13





Fig. 14

4. Press the  button to exit the main menu and resume normal operation.

continued...

Advanced Settings Menu

1. Press the **SET** button when  is highlighted to enter the sub-menu.
2. Use the  and  buttons to toggle between the features listed (Fig. 15).
3. Once the appropriate parameter has been selected follow the associated instructions below.





Note: At any time, press the  button twice to exit and resume normal operation.



Fig. 15

Setting the Language

1. Press the **SET** button when "Language" is highlighted to enter the appropriate function.
2. Press the  and  buttons to scroll through the list of languages.
3. Press the **SET** button to confirm selection.
4. Press the  button to exit the "Language" function and return to advanced settings.

Note: At any time, press the  button twice to exit and resume normal operation.

Setting the Date and Date Format







1. Press the **SET** button when "Date & Time" is highlighted to enter the appropriate function.
2. Use the  and  buttons to select the parameter to be adjusted.
3. Press the **SET** button followed by the  and  buttons to adjust the selected parameter (Fig. 16).
4. Press the **SET** button again to confirm selection.
5. Repeat steps 2 through 4 for each required parameter.
6. Press the  button to exit the "Date & Time" function when complete and return to advanced settings.



Fig. 16

Note: At any time, press the  button twice to exit and resume normal operation.

continued...

Switching the Unit of Measure (°F/°C)

1. Press the **SET** button when "Temperature Unit" is highlighted to enter the appropriate function.
2. Use the \wedge and \vee buttons to select between °C or °F.
3. Press the **SET** button to confirm selection.
4. Press the \leftarrow button to exit the "Temperature Unit" function when complete and return to advanced settings.

Note: At any time, press the \leftarrow button twice to exit and resume normal operation.

Setting the High/Low Alarm Values

1. Press the **SET** button when "HI/LO Alert" is highlighted to enter the appropriate function.
2. Use the \wedge and \vee buttons to select the alarm value to be adjusted or to Enable (On) or Disable (Off) the applicable temperature alerts (Fig. 17).
3. Press the **SET** button to confirm selection.
4. Use the \wedge and \vee buttons to increase or decrease the alarm values when applicable.
5. Press the **SET** button to confirm selection.
6. Repeat steps 2 through 5 for each parameter.



Fig. 17

HI – When triggered an alarm icon in Red will appear on the display.

LO – When triggered an alarm icon in Green will appear on the display.

LED Alert – When the HI alarm is triggered, the Dual LED flashlight will blink on and off repeatedly.

7. Press the \leftarrow button to exit the "HI/LO Alert" function and return to advanced settings.

Note: At any time, press the \leftarrow button twice to exit and resume normal operation.

continued...

Adjusting Emissivity

1. Press the **SET** button when "Measurements" is highlighted to enter the appropriate function.
2. Press the **SET** button again to adjust the selected emissivity (Fig. 18).
3. Use the \wedge and \vee buttons to increase or decrease the emissivity values.
4. Press the **SET** button to confirm selection.
5. Press the \leftarrow button to exit the "Measurements" function and return to advanced settings.

Note: At any time, press the \leftarrow button twice to exit and resume normal operation.

Setting the LCD Brightness

1. Press the **SET** button when "Display Brightness" is highlighted to enter the appropriate function.
3. Use the \wedge and \vee buttons to select the desired brightness level between "Low", "Medium" or "High" (Fig. 19).
4. Press the **SET** button to confirm selection.
5. Press the \leftarrow button to exit the "Display Brightness" function and return to advanced settings.

Note: At any time, press the \leftarrow button twice to exit and resume normal operation.

Enabling/Disabling Auto Power OFF

1. Press the **SET** button when "Auto Power Off" is highlighted to enter the appropriate function.
2. Press the \wedge and \vee buttons to select the desired Auto Power Off option between "Off", "5 Min", "10 Min" or "30 Min" (Fig. 20).
3. Press the **SET** button to confirm selection.



Fig. 18

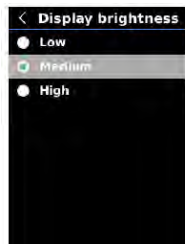

Fig. 19

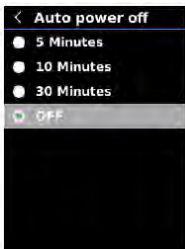





Fig. 20

continued...

4. Press the  button to exit the "Auto Power Off" function and return to advanced settings.

Note: At any time, press the  button twice to exit and resume normal operation.

Changing USB Mode

1. Press the **SET** button when "USB mode" is highlighted to enter the appropriate function.
2. Press the  and  buttons to select the desired USB mode between "File Transfer" and "Live Projection".

File Transfer – This USB mode should be selected when transferring files between the camera and PC.



Live Projection – This USB mode should be selected when the camera is being used to project real-time measurements on a PC.

Note: The desired USB Mode should be selected prior to connecting the camera to a PC.

3. Press the **SET** button to confirm selection.
4. Press the  button to exit the "USB mode" function and return to advanced settings.

Note: At any time, press the  button twice to exit and resume normal operation.

Enable/Disable Auto Save

1. Press the **SET** button when "Auto save" is highlighted to enter the appropriate function.
2. Press the  and  buttons to Enable (Yes) or Disable (No) the auto save function (Fig. 21).
3. Press the **SET** button to confirm selection.
4. Press the  button to exit the "Auto save" function and return to advanced settings.

Note: At any time, press the  button twice to exit and resume normal operation.

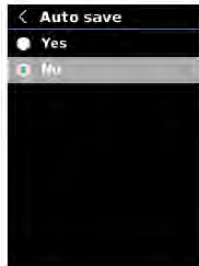

Fig. 21

continued...

System Settings

1. Press the **SET** button when "System settings" is highlighted to enter the appropriate function.
2. Press the \wedge and \vee buttons to scroll through the list of parameters (Fig. 22).
3. Once the appropriate parameter has been selected follow the associated instructions below.

Device Information

1. Press the **SET** button when "Device information" is highlighted to view detailed information of the device (Fig. 23).
2. Press the \leftarrow button to exit the "Device information" function and return to advanced settings.

Note: At any time, press the \leftarrow button twice to exit and resume normal operation.

Factory Reset

1. Press the **SET** button when "Factory reset" is highlighted to view detailed information of the device.
2. Press the \wedge and \vee buttons to select between "Yes" or "No" (Fig. 24).
3. Press the **SET** button to confirm selection.
4. Press the \leftarrow button to exit the "Factory reset" function and return to advanced settings.

Note: At any time, press the \leftarrow button twice to exit and resume normal operation.



Fig. 22



Fig. 23

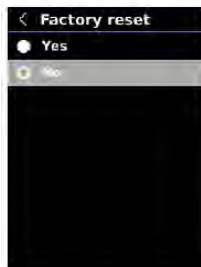

Fig. 24

continued...

Formatting the SD Card

1. Press the **SET** button when "Format sdcard" is highlighted to view detailed information of the device.
2. Press the \wedge and \vee buttons to select between "Yes" or "No" (Fig. 25).
3. Press the **SET** button to confirm selection.
4. Press the \leftarrow button to exit the "Format sdcard" function and return to advanced settings.

Note: At any time, press the \leftarrow button twice to exit and resume normal operation.

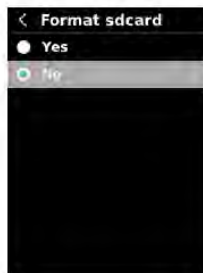

Fig. 25

Turning the LED Flashlight ON/OFF

The camera is equipped with Dual LED flashlights. Press and hold the LED Light button to turn the flashlight on and off.

Saving, Viewing & Deleting Images

While in normal operation, multiple images can be saved to the Micro SD card (Fig. 26).

1. To save an image, pull the trigger and use the \leftarrow and \rightarrow buttons to discard (X) or save \checkmark the image.

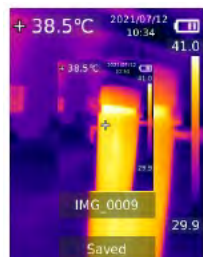
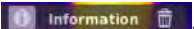

Fig. 26

Note: While in auto save mode, the image will automatically be saved to the SD card.

2. To display a saved image, press the \triangleright button to enter the saved pictures gallery.
3. Use the \leftarrow and \rightarrow buttons to scroll through the list of saved images if applicable (Fig. 27).
4. Press the **SET** button to select an image and view in full screen.
5. Press the **SET** button to enter the saved picture toolbar as indicated by .

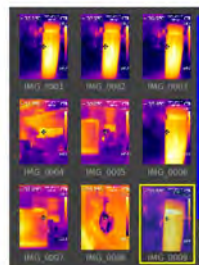

Fig. 27

continued...

6. Use the < and > buttons to select between "Information" ⓘ to view all relevant information on the saved image or "Delete" the saved image 🗑️.
7. Press the **SET** button to confirm your selection.
8. If "Information" is selected, the display will appear as shown in Fig. 28.
8. Press the ⬅️ button to return to the saved pictures screen.
9. If "Delete" is selected, use the < and > buttons to select between "Yes" or "No" as shown in Fig. 29.
10. Press the **SET** button to confirm your selection.

Note: At any time, press the ⬅️ button twice to exit and resume normal operation.

Charging the Battery

1. Connect the R2165 via the included cable to a USB port on your PC or into a wall outlet using a USB Power Adapter (not included) to charge the Li-ion battery.
2. Charge the meter until the battery indicator appears full and remove the charging cable when done.

Applications

- Home and Building Inspection
- Plant and General Maintenance
- Electrical and Mechanical Inspection
- Predictive Maintenance
- HVAC/R & Plumbing
- Equine & Veterinary
- Road Construction



Fig. 28

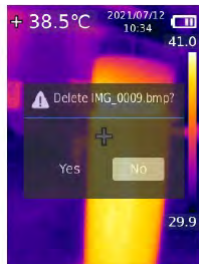

Fig. 29

Accessories and Replacement Parts

R8888 Medium Hard Carrying Case

R1500 Tripod

RSD-16GB Micro SD Memory Card w/Adapter, 16GB

Don't see your part listed here? For a complete list of all accessories and replacement parts visit your product page on www.REEDInstruments.com.

Product Care

To keep your instrument in good working order we recommend the following:

- Store your product in a clean, dry place.
- Clean your product and accessories with biodegradable cleaner. Do not spray the cleaner directly on the instrument. Use on external parts only.

Product Warranty

REED Instruments guarantees this instrument to be free of defects in material or workmanship for a period of one (1) year from date of shipment. During the warranty period, REED Instruments will repair or replace, at no charge, products or parts of a product that proves to be defective because of improper material or workmanship, under normal use and maintenance. REED Instruments total liability is limited to repair or replacement of the product. REED Instruments shall not be liable for damages to goods, property, or persons due to improper use or through attempts to utilize the instrument under conditions which exceed the designed capabilities. In order to begin the warranty service process, please contact us by phone at 1-877-849-2127 or by email at info@reedinstruments.com to discuss the claim and determine the appropriate steps to process the warranty.

Product Disposal and Recycling



Please follow local laws and regulations when disposing or recycling your instrument. Your product contains electronic components and must be disposed of separately from standard waste products.

Product Support

If you have any questions on your product, please contact your authorized REED distributor or REED Instruments Customer Service by phone at 1-877-849-2127 or by email at info@reedinstruments.com.

Please visit www.REEDInstruments.com for the most up-to-date manuals, datasheets, product guides and software.

*Product specifications subject to change without notice.
All rights reserved. Any unauthorized copying or reproduction of this manual is strictly prohibited without prior written permission from REED Instruments.*

REED INSTRUMENTS

TEST & MEASURE WITH CONFIDENCE



Over 200 portable test and
measurement instruments

Access our
Product Catalog



REED INSTRUMENTS

TEMPERATURE
& HUMIDITY



SOUND



MOISTURE



AIR VELOCITY



ELECTRICAL

