

MAESTRO INSTALLATION

PROPER INSTALLATION IS IMPORTANT. IF YOU NEED ASSISTANCE, CONSULT A CONTRACTOR, ELECTRICIAN OR TELEVISION ANTENNA INSTALLER (CHECK WITH YOUR LOCAL BUILDING SUPPLY, OR HARDWARE STORE FOR REFERRALS). TO PROMOTE CONFIDENCE, PERFORM A TRIAL WIRING BEFORE INSTALLATION.

- 1 Determine where you are going to locate both the rooftop sensors and the read-out.

Feed the terminal lug end of the 2-conductor cable through one of the rubber boots and connect the lugs to the terminals on the bottom of the wind speed sensor. (Do NOT adjust the nuts that are already on the sensor). The polarity does not matter.

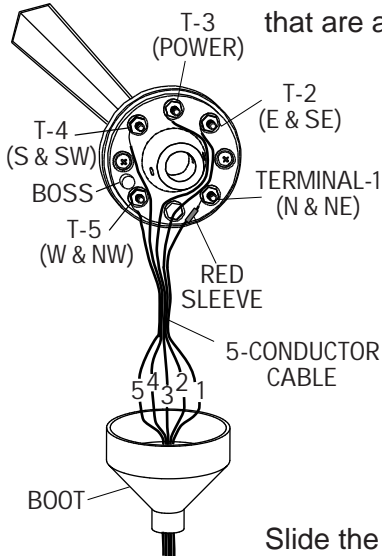
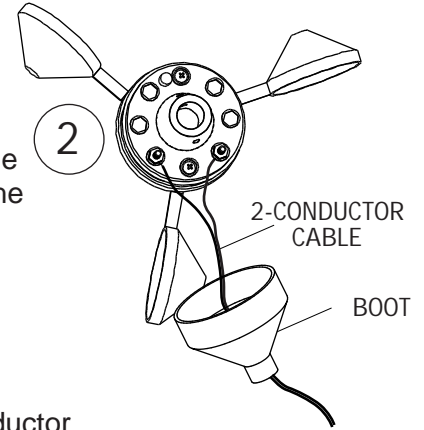

- 3 Feed the terminal lug end of the five-conductor cable through the other rubber boot and connect the lugs to the terminals on the bottom of the wind-direction sensor. (Do NOT adjust the nuts that are already on the sensor). The red sleeve indicates wire #1.

Slide the stub masts through the rubber boots and insert the stub masts into the bottom of the sensors. Secure with the cotter pins. Coat all wire connections with silicone sealant and slip the boots over the sensors.

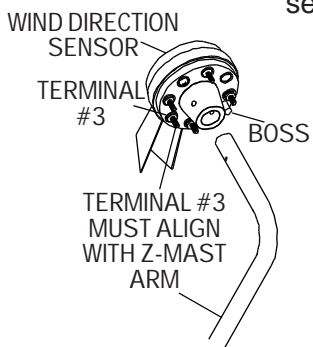
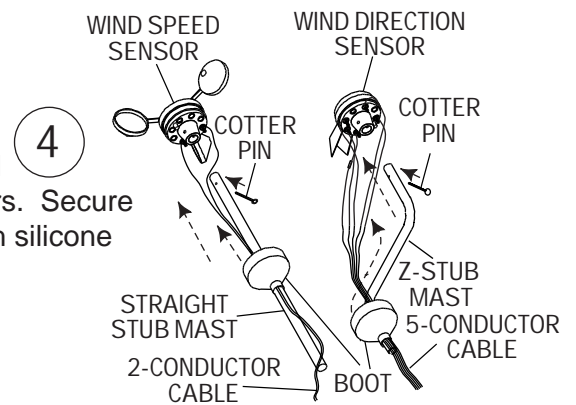

- 4A When assembling the wind direction sensor to the Z-mast, make certain that terminal #3 is aligned with the Z-mast arm.

Secure the sensors and stub masts to your antenna mast (not supplied) with the two hose clamps. **Align the wind-direction Z-mast arm to true North.** Radio Shack and similar stores have a selection of tall masts and roof mounting brackets. Choose a mount that best suits your location and provides at least eight feet of vertical clearance above objects on the roof.

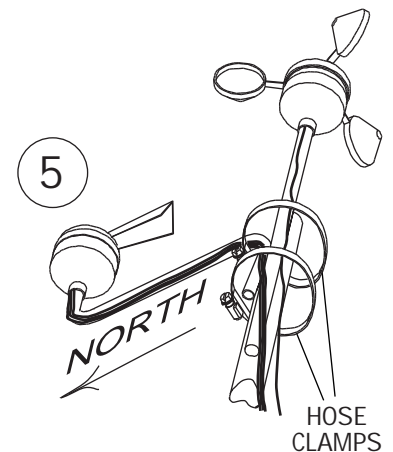

MAXIMUM INC.

MAESTRO

INSTALLATION

(continued)

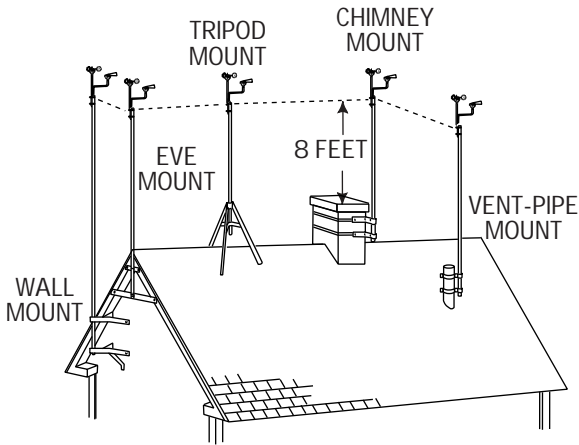

6

Follow the instructions supplied with the antenna mount and secure the mast to the mount.

Secure the wire to the building using cable clips (do not use regular staples). Form a drip loop where the wires enter the hole drilled through the exterior wall. Caulk the hole when done.

7

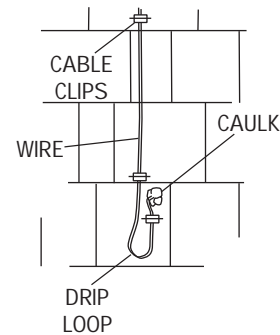

8

Feed the cables through the wall to where the read-out is going to be located. Attach the wires to the rear of the read-out as shown. The direction wires must follow in sequence for the direction sensor. The polarity does not matter for the wind speed or power supply connections. (Do NOT adjust the nuts that are already on the meter).

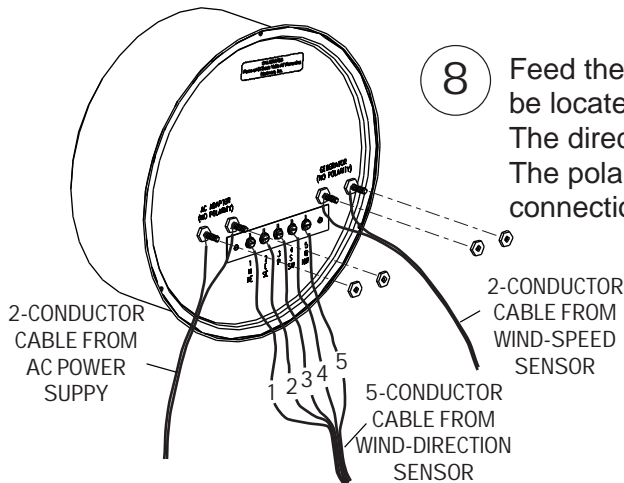

9

Mount the brass read-out directly over the cable feed-thru-hole to avoid crimping the wire under the lip. We recommend mounting the read-out on one of our pre-drilled and centered panels. Plug the power supply into a 110 VAC power outlet.

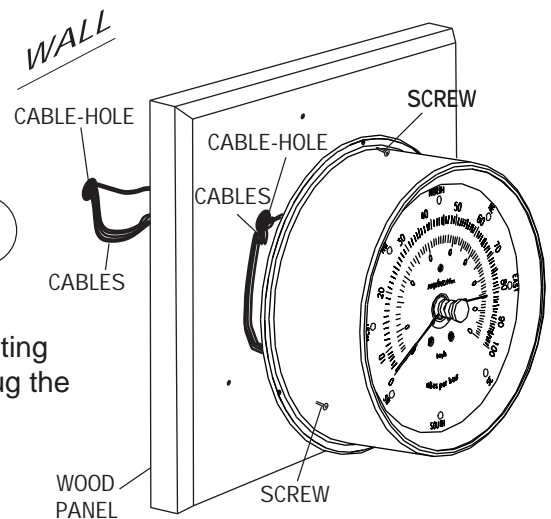

MAXIMUM INC.

MAESTRO

OPERATION

To reset the gust register needle, turn the knob counter-clockwise.

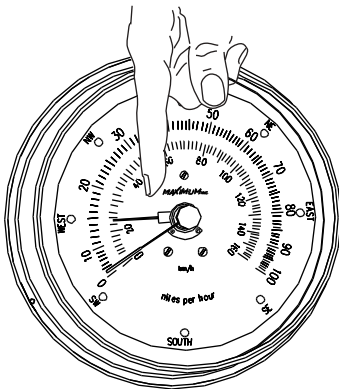
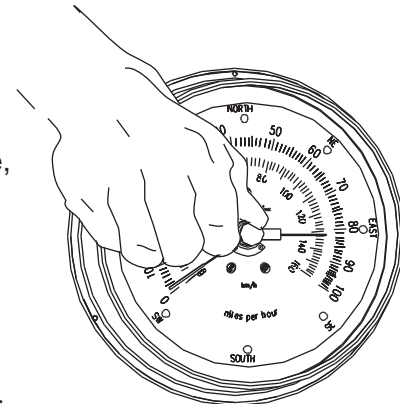

Turning the knob counter-clockwise will eventually contact the gust register. The Gust Register should not be set under 15 MPH - this gives the needle room to operate at low speeds. If the Gust Register is set below 15 MPH turn the knob clockwise until the needle registers greater than 15 MPH.

After setting the Gust Register turn the knob clockwise until the reset arm is parked near the six o'clock position. Failure to do so may damage your meter.

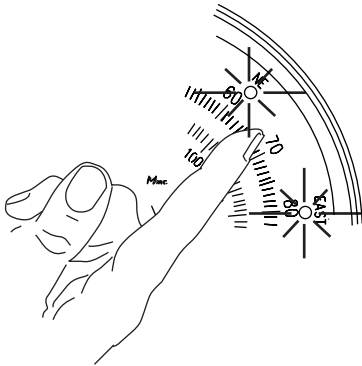
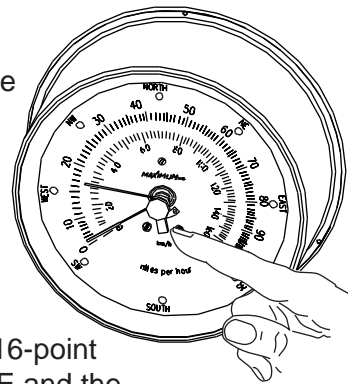

The wind direction may be read with 16-point accuracy. In this example both the NE and the E indicator lamps are illuminated. This would be read as East-Northeast.

ADDITIONAL INFORMATION

Cables can be shortened or lengthened without affecting accuracy

WIRE GAUGE	MAXIMUM FEET WITHOUT RECALIBRATION	WIRE GAUGE	MAXIMUM FEET WITHOUT RECALIBRATION
24	300'	16	2000'
22 (supplied with instrument)	500'	14	3200'
20	750'	12	5000'
19	1000'	10	8000'
18	1250'		

MAXIMUM INC.

MAESTRO

TROUBLE SHOOTING

Maximum Instruments are accurate and reliable. Most problems that occur are due to loose or corroded connections. If, after checking the connections, there is still a problem, determine if the problem is with the sensor or the brass read-out.

WIND SPEED

- ① Disconnect the two wind-speed wires from the back of the brass read-out.
- ② Attach a low range *AC Analog Voltmeter* to the wires. If the speed sensor is operating properly, you will achieve these approximate readings: 8-9 MPH = 0.28 VAC rms, 17 MPH = 0.56 VAC rms, 51 MPH = 1.78 VAC rms, 102 MPH 3.67 VAC rms
- ③ If the speed sensor delivers these approximate readings, then the brass read-out is faulty. If the speed sensor does not produce these readings, then either the speed sensor or the wire is faulty.

WIND DIRECTION

- ① Unplug the AC Power Adaptor.
- ② Disconnect the AC Adaptor wires and the 5-conductor cable wires from the back of the brass read-out.
- ③ Connect an AC Voltmeter to the two wires coming from the AC Power Adaptor.
- ④ Plug in the AC Power Adaptor to a 110 VAC outlet. When functioning properly, the adaptor will deliver 11.5-18 VAC. If the adaptor checks out fine, proceed further with the test. If not, send both the adaptor and the instrument to Maximum.
- ⑤ If the AC Adaptor checks okay, unplug the Adapter and re-connect the two wires to the back of the brass read-out.
- ⑥ Plug in the AC Power Adapter.
- ⑦ Using a small piece of wire or a paper clip as a jumper, touch one end to terminal #3 (the middle one of the five). Touch the other end to terminal #1, then #2, then #4 and lastly #5 (keeping one end of the jumper on terminal #3). At each terminal, two adjacent lights should light up simultaneously. If any light fails to function properly, the fault lies within the brass read-out.
- ⑧ If all the lights function properly, then the problem lies with either the wiring or with the outdoor wind direction sensor. Disconnect the wires at the sensor and bring it down to the brass read-out.
- ⑨ Use a short piece of the 5-wire cable and reconnect the sensor to the brass readout as shown in the installation instructions.
- ⑩ Rotate the vane slowly by hand and observe the lights on the brass read-out. If they operate properly, then the installed wiring is at fault; if not, then the outdoor wind direction sensor is faulty.

MAXIMUM INC.

IMPORTANT ADDITIONAL INFORMATION

Components: Along with the indicator, the following components are included with this instrument:

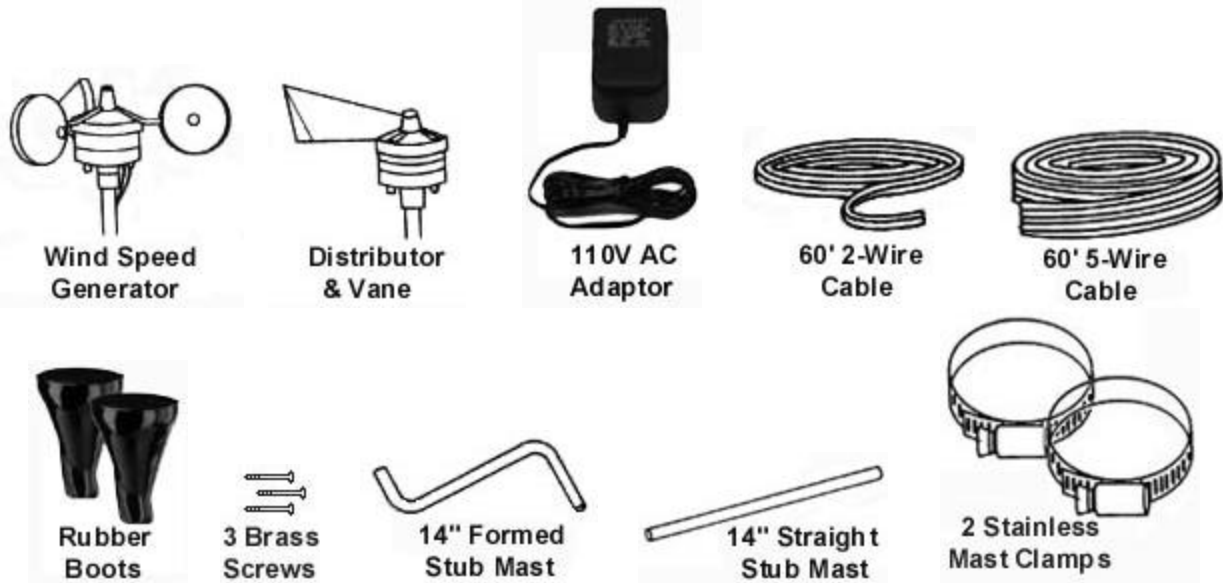

Rooftop sensors: To insure a clear unobstructed path for the wind to the sensors, they should be mounted on some type of antenna mast at least 8-10' above the highest object on your roof. Remember, your roof is also an obstruction and it usually requires at least 8' of height to avoid the turbulence it creates.

AC Adaptor: This instrument requires its own AC Adaptor. Due to the various power requirements of each Maximum instrument, attempting to run more than one instrument on a single adaptor could cause improper operation and/or damage to the instrument(s) thereby voiding your 5-year warranty.

Sensors: Properly installed, your sensors will require virtually no maintenance at all. Our sensors do not utilize brushes or wiping contacts. All bearings are Rulon-J self lubricating type and will perform for many years in the harshest environments.

Brass Case: Your brass case is solid brass A70-30 Holloware quality, with a durable lacquer finish. It is in fact a piece of jewelry and should be treated as such. It should be cleaned at least once a week to keep airborne pollutants (dust, etc...) and any moisture from collecting on the case thereby attacking the lacquer. At no time should you use an abrasive cleaner or cloth on the brass case. Simply use a soft cloth or soft paper towel with a mild glass cleaner to wipe the case clean. If your instruments are in a summer home, and you are not able to clean them regularly, simply lay a small cloth or towel across the top two-thirds so that dust cannot settle on the finish.

Specifications: All instrumentation or measuring devices have accuracy tolerances and specifications. Making comparisons between different pieces of equipment is appropriate provided the specified accuracies of both are known.

	Measurement Range	Guaranteed Accuracy
Wind Speed	0-100 MPH	±3% Full Scale & Mid Scale
Wind Direction (Indicator)	16 Compass Points	Zero Error (Digital Display System)
Wind Direction (Sensor)		±11.25 Degrees



Electrical Damage – Common Causes & Recommended Prevention

Electrical damage can be caused by many different factors. Below are some of the more common causes and some suggested methods of minimizing potential problems.

Common Causes:

- **Storm Activity** – lightning in your area can do damage to your instruments in different ways. The obvious way is due to a direct or nearby strike. In addition, lightning storms, dust storms, dry snowstorms and strong dry winds can all cause static electricity to build up on and around your external sensors. Regardless of the cause this built up electricity can discharge itself through the cable connecting the external sensors to the instrument.
- **Power Surges** – A surge may come from the electric company's switching generators or power grids, from local industries or after power interruption when accumulated power suddenly surges back through AC lines. Even the on-and-off switching of large electrical appliances, such as refrigerators or clothes dryers can create damaging fluctuations. This is especially true with sensitive weather recording devices.
- **Yourself** – Are you constantly giving and/or receiving a shock every time you touch a doorknob or another person? If so you have a great deal of static electricity in your environment. Depending on where you live, static electricity may be a year round problem or only a seasonal problem. In either case, it is possible for a person to carry enough of a charge to damage an instrument.

Recommended Prevention:

Ground Your Mounting Mast – *IMPORTANT: PVC and fiberglass are not recommended mast materials as they can store high amounts of static electricity within themselves.* It is recommended that you follow the grounding instructions that came with your mounting mast, while also maintaining accordance to your local Electric Code. In the absence of instructions for your mast system, the following generic guidelines from the **National Electric Code** may be helpful.

- 1) The NEC requires that the antenna mast and mount be grounded directly. No splices or connections are allowed in the ground wire between the mast and the ground rod.
 - 2) Attach one end of a No. 8 (or thicker) copper or aluminum ground wire to the antenna mast. **Note:** As static electricity issues are more common for weather sensors than direct lightning strikes, consider installing the ground wire as physically close to the wind sensors as possible to best combat static electricity issues. For multi-piece (or telescoping) masts, consider connecting the ground to each separate section of the mast.
 - 3) For painted or coated masts, scrape off the coating around the area where the contact will be made. This will ensure a good, solid connection. (Once the ground is attached to the mast, any scraped off portion that is exposed should be recoated with paint or other sealant.)
 - 4) Next, run the ground wire to ground as directly as possible. Standard wire staples can be used to secure the ground wire against the side of the house. Avoid making 90° or sharper turns with the ground wire. A lightning charge has difficulty making such a turn and therefore may discharge into the house. Make ground wire bends as smooth and as gradual as possible.
 - 5) The ground wire must be connected to a ground rod. Water pipes or plumbing fixtures are not acceptable. A good copper-coated steel ground rod driven at least 3 feet into the ground is required. Special clamps that provide a solid connection between the ground wire and ground rod should be used
- **Use Surge Protectors** – For the AC adapter, a UL 1449 rated surge protector with EMI/RFI filtering is recommended. This rating will be clearly listed on the packaging of any good quality surge protector.
 - **Discharge Yourself** – If the instruments are located in an environment where static electricity is a problem, make sure that you discharge yourself before touching the instrument(s). The shock that you get from touching a doorknob or another person can often be sufficient to damage an instrument.