

# METRAHIT | ENERGY

## TRMS System Multimeter

3-349-576-03  
3/9.11



## Standard Equipment – Contact Persons

### Scope of Delivery

- 1 TRMS system multimeter METRAHIT ENERGY (M249A)
- 1 KS29 measurement cable set (Z229A)
- 2 Batteries
- 1 Condensed operating instructions
- 1 CD ROM (with operating instructions, data sheet and more)
- 1 DKD calibration certificate
- 1 Rubber holster and carrying strap

### Overview

Function	
Power measurement	W (Var, VA, PF)
Energy measurement	Wh (varh, VAh)
Events recording	DC / AC events
Power disturbance recording	PQ
Harmonic analysis	 V, A
Voltage (Ri ≥ 17 MΩ)	V <sub>DC</sub>
Voltage (Ri ≥ 9 MΩ)	V <sub>AC</sub> TRMS
Voltage (Ri ≥ 9 ... 17 MΩ)	V <sub>AC+DC</sub> TRMS
Crest factor (1 ≤ CF ≤ 11)	✓
Frequency in Hz with V <sub>AC</sub>	... 300 kHz
Low-pass filter	1 kHz with VAC
Bandwidth for V <sub>AC+DC</sub> or V <sub>AC</sub>	100 kHz
Pulse frequency in MHz at 5V TTL	1 Hz...1 MHz
Duty cycle as %	2.0% ... 98%
Voltage level measurement in dB	✓
Resistance	Ω
Conductivity	nS
Low-resistance measurement where I <sub>CONST</sub> = 3 mA	R <sub>SL</sub>

Function	
Continuity test where I <sub>CONST</sub> = 1 mA	✓
Diode test where I <sub>CONST</sub> = 1 mA	✓
Temperature °C/°F with T <sub>C</sub>	Type K
Temperature °C/°F R <sub>TD</sub>	Pt100/Pt1000
Capacitance in F	✓
Cable length in m	✓
Current	A <sub>DC</sub>
	A <sub>AC</sub> TRMS
	A <sub>AC+DC</sub> TRMS
Bandwidth for A <sub>AC+DC</sub> or A <sub>AC</sub>	10 kHz
Frequency in Hz for A <sub>AC</sub>	... 60 kHz
Current clamp measurement with adjustable transformation ratio	∞ mV / A ∞ mA / A
Relative value measurement (ref. value measurement) ΔREL	✓
Zero point	✓
Data logger function <sup>1</sup> (memory)	16 MBit
Min-Max / data hold	✓
IR interface (38.4 kBd)	✓
Power pack socket	✓
Rubber holster	✓
Fuse	10 A / 1000 V
Protection <sup>3</sup>	IP 52
Measuring Category	600 V CAT III 300 V CAT IV
Calibration	DKD

<sup>1</sup> 16 Mbit = 2048 kByte = up to 300,000 measured values,  
sampling rate adjustable from 0.5 second to 9 hours

Contents	Page	Contents	Page
<b>1 Safety Features and Precautions .....</b>	<b>7</b>	<b>5 Measurements .....</b>	<b>25</b>
1.1 Use for Intended Purpose .....	9	5.1 Voltage Measurement .....	25
1.2 Meanings of Danger Symbols .....	9	5.1.1 Direct Voltage, Pulsating Voltage and Crest Factor Measurement – V DC, V (DC+AC) and CF .....	26
1.3 Meanings of Acoustic Warning Signals .....	9	5.1.2 Alternating Voltage and Frequency Measurement V AC and Hz with Selectable Low-Pass Filter, V AC + FILTER and dB V AC .....	30
<b>2 Operating Overview – Connections, Keys, Rotary Switch, Symbols . 10</b>		5.1.3 Mains Monitoring / Mains Disturbance Recording – PQ .....	33
<b>3 Initial Start-Up .....</b>	<b>14</b>	5.1.4 Mains Disturbance Recording in Memory Mode Operation .....	35
3.1 Inserting Batteries or Rechargeable Batteries .....	14	5.1.5 Harmonic Analysis (voltage measurement) .....	36
3.2 Switching the Instrument On .....	14	5.1.6 Frequency and Duty Cycle Measurement .....	38
3.3 Setting the Operating Parameters .....	14	5.2 Resistance, Conductivity and Low-Resistance Measurement .....	39
3.4 Switching the Instrument Off .....	15	5.2.1 Conductivity Measurement .....	40
<b>4 Control Functions .....</b>	<b>16</b>	5.2.2 Low-Resistance Measurement with Constant Current (RPE) .....	40
4.1 Selecting Measuring Functions and Measuring Ranges .....	16	5.3 Continuity Test with Constant Current of 1 mA .....	41
4.1.1 Automatic Measuring Range Selection (auto-ranging) .....	16	5.4 Diode Testing with Constant Current of 1 mA .....	42
4.1.2 Manual Measuring Range Selection .....	16	5.5 Temperature Measurement .....	43
4.1.3 Peak Value Monitoring for Automatic and Manual Measuring Range Selection .....	17	5.5.1 Measurement with Thermocouples, Temp TC .....	43
4.1.4 Quick Measurements (MAN or DATA function) .....	18	5.5.2 Measurement with Resistance Sensors .....	44
4.2 Zero Offset / Relative Measurements – ZERO/Delta REL Function .....	18	5.6 Measuring Capacitance and Cable Length in km .....	45
4.3 Display (LCD) .....	19	5.6.1 Cable Length Measurement in m .....	46
4.4 Measured Value Storage: DATA (auto-hold / compare) .....	20	5.7 Measurement of Active, Apparent and Reactive power – W, VA, VAR Measurement of Active, Apparent and Reactive Energy – Wh, VAh, VARh .....	47
4.4.1 Saving Minimum and Maximum Values – Min/Max Function .....	21	5.8 Current measurement .....	52
4.5 Measurement Data Recording – Memory Mode Operation, STORE Menu Function .....	22	5.8.1 Direct Current Measurement .....	53
4.5.1 Rapid Momentary Value Acquisition for U DC and I DC .....	24	5.8.2 Current Measurement with Current Clamp Sensor .....	56
4.5.2 Power and Energy Measurement in the Memory Mode .....	24	5.8.3 Current Measurement with Current Clamp Transformer .....	58
		<b>6 Device and Measuring Parameters .....</b>	<b>60</b>
		6.1 Paths to the Various Parameters .....	61
		6.2 List of all Parameters, Main Menus and Submenus .....	62

## Table of Contents

Contents	Page	Contents	Page
6.3 Querying Parameters – InFo Menu (as moving letters) .....	63	(KS17-2 safety cable set included with instrument) .....	89
6.4 Entering Parameters – SETUP Menu .....	64	10.3 NA X-TRA Power Pack (Z218G: not included) .....	89
6.4.1 SYSTEM Submenu .....	64	10.4 PMA 16 Power Measuring Adapter (Z228A: not included) .....	90
6.4.2 EVEntS Submenu .....	65	10.5 Interface Accessories (not included) .....	90
6.4.3 General Parameters .....	66	<b>11 Glossary – Abbreviations of Measuring Functions and Measuring Parameters with their Meanings .....</b>	<b>92</b>
6.4.4 EnErGY Submenu .....	68	<b>12 Index .....</b>	<b>96</b>
6.4.5 MAInS Submenu .....	69		
6.4.6 HARm Submenu .....	71		
6.4.7 StorE Submenu – Parameters for Memory Mode Operation .....	72		
6.5 Default Settings (factory settings) – Reset .....	74		
<b>7 Interface Operation .....</b>	<b>75</b>		
7.1 Activating the Continuous Transmission Mode .....	75		
7.2 Configuring Interface Parameters .....	76		
<b>8 Technical Data .....</b>	<b>77</b>		
<b>9 Maintenance and Calibration .....</b>	<b>85</b>		
9.1 Displays – Error Messages .....	85		
9.2 Batteries .....	85		
9.3 Fuse .....	86		
9.4 Housing Maintenance .....	87		
9.5 Return and Environmentally Sound Disposal .....	87		
9.6 Recalibration .....	87		
9.7 Manufacturer's Guarantee .....	88		
<b>10 Accessories .....</b>	<b>89</b>		
10.1 General .....	89		
10.2 Technical Data for Measurement Cables			

## 1 Safety Features and Precautions

You have selected an instrument which provides you with high levels of safety.

This instrument fulfills all requirements of applicable European and national EC directives. We confirm this with the CE mark. The relevant declaration of conformity can be obtained from GMC-I Messtechnik GmbH.

The TRMS digital multimeter has been manufactured and tested in accordance with the following safety regulations: IEC 61010-1:2001 / DIN EN 61010-1/VDE 0411-1:2002. When used for its intended purpose (see page 9), safety of the operator, as well as that of the instrument, is assured. Their safety is however not guaranteed, if the instrument is used improperly or handled carelessly.

**In order to maintain flawless technical safety conditions, and to assure safe use, it is imperative that you read the operating instructions thoroughly and carefully before placing your instrument into service, and that you follow all instructions contained therein.**

The multimeter is equipped with an **automatic socket blocking mechanism** for your safety, and in order to safeguard your instrument. This mechanism is linked to the rotary switch and only allows access to those jacks which are actually required for the selected function (exception: the voltage jack is open during current measurement, but a visible red ring warns the user of possible incorrect connection). The socket blocking mechanism also prevents the user from turning the rotary switch to impermissible functions after the measurement cables have already been plugged in.

If dangerous voltages are applied in the high-impedance voltage measuring functions (switch position V or PQ), switching to low-impedance measuring functions (switch position MHz,  $\Omega$ , continuity, temperature or capacitance) causes "HiVolT" to appear at the display and the respective measurement is disabled.

Hazardous contact voltages are not detected when the ohm or capacitance measurement is selected.

If the instrument switches itself off in the event that hazardous contact voltage is applied (only possible during memory mode operation), the high-voltage warning symbol remains visible at the display.

### Measuring Categories and their Significance per IEC 61010-1

CAT	Definition
I	Measurements in electrical circuits which are not directly connected to the mains, e.g. <i>electrical systems in motor vehicles and aircraft, batteries etc.</i>
II	Measurements in electrical circuits which are directly connected to the low-voltage mains <i>via plug, e.g. in household, office and laboratory applications etc.</i>
III	Measurements in building installations: Stationary consumers, distributor terminals, devices connected permanently to the distributor
IV	Measurements at power sources for low-voltage installations: meters, mains terminals, primary overvoltage protection devices

The measuring category and the associated maximum rated voltage which are printed on the device apply to your measuring instrument, e.g. 600 V CAT III.

### Observe the following safety precautions:

- The multimeter may not be used in **potentially explosive atmospheres**.
- The multimeter may only be operated by persons who are capable of recognizing **contact hazards** and taking the appropriate safety precautions. Contact hazards according to the standard exist anywhere, where voltages of greater than 33 V TRMS or 70 V DC may occur. Avoid working alone when taking measurements which involve contact hazards. Be certain that a second person is present.

## Safety Precautions

---

- **Maximum permissible voltage**  
between the voltage measuring sockets or all connector sockets and ground is 600 V for measuring category III and 300 V for measuring category IV.
- Be aware of the fact that dangerous voltage peaks with significant frequency components of greater than 1 kHz are not displayed when the **low-pass filter** is activated. We recommend measuring voltage without the low-pass filter first, in order to be able to detect any dangerous voltages.
- Be prepared for the occurrence of unexpected voltages at devices under test (e.g. defective devices). For example, capacitors may be dangerously charged.
- Make certain that the measurement cables are in flawless condition, e.g. no damage to insulation, no interruptions in cables or plugs etc.
- No measurements may be made with this instrument in electrical circuits with corona discharge (high-voltage).
- Special care is required when measurements are made in HF electrical circuits. Dangerous pulsating voltages may be present.
- Measurements under moist ambient conditions or with an instrument with condensation are not permissible
- Be absolutely certain that the measuring ranges are not overloaded beyond their allowable capacities. Limit values are included in section 8, "Technical Data", in the table entitled "Measuring Functions and Measuring Ranges" in the "Overload Capacity" column.

- **The multimeter may only be operated with installed batteries or rechargeable batteries. Dangerous currents and voltages are otherwise not indicated, and the instrument may be damaged.**
- The instrument may not be operated if the fuse cover or the battery compartment lid has been removed, or if its housing is open.
- The input for the current measuring range is equipped with a fuse link. Use specified fuses only (see page 84)! The fuse must have a **breaking capacity of at least 30 kA**.
- Observe optical and acoustic warning signals (see section 1.2 and section 1.3).

### Repair and Parts Replacement

When the instrument is opened, voltage conducting parts may be exposed. The instrument must be disconnected from the measuring circuit before performing repairs or replacing parts. If repair of a live open instrument is required, it may only be carried out by trained personnel who are familiar with the dangers involved.

### Defects and Extraordinary Strains

If it may be assumed that the instrument can no longer be operated safely, it must be removed from service and secured against unintentional use.

Safe operation can no longer be relied upon:

- If the device demonstrates visible damage
- If the instrument no longer functions, or if malfunctioning occurs
- After long periods of storage under unfavorable conditions (e.g. humidity, dust or extreme temperature (see "Ambient Conditions" on page 84).

### 1.1 Use for Intended Purpose

- The multimeter is a portable device which can be held in the hand during the performance of measurements.
- Only those types of measurements described in section 5 may be performed with the measuring instrument.
- The measuring instrument, including measurement cables and plug-on test probes, may only be utilized up to the maximum specified measuring category (see page 84 and the table on page 7 regarding significance).
- Overload limits may not be exceeded. See technical data on page 77 for overload values and overload limits.
- Measurements may only be performed under the specified ambient conditions. See page 84 regarding operating temperature range and relative humidity.
- The measuring instrument may only be used in accordance with the specified degree of protection (IP code) (see page 84).

### 1.2 Meanings of Danger Symbols



Warning concerning a source of danger (attention: observe documentation!)



**Warning at the display regarding dangerous contact voltage at the voltage measuring input (jacks 8 and 10, see page 10):**  
**U > 30 V AC or U > 35 V DC**



#### Note

For safety reasons, the instrument cannot be switched off when dangerous contact voltages are being applied.



#### Note

Electrical discharge or high frequency interference may cause incorrect displays to appear. To reset the instrument, switch it off and then back on again. See also section 6.5 with regard to restoring the factory settings.

### 1.3 Meanings of Acoustic Warning Signals

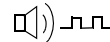

**Voltage warning: > 600 V (intermittent acoustic signal)**

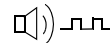

**Current warning: > 10 A (intermittent acoustic signal)**

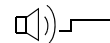

**Current warning: > 16 A (continuous acoustic signal)**

### 2 Operating Overview – Connections, Keys, Rotary Switch, Symbols







- 1 Display (LCD) (see page 12 for significance of symbols)
- 2 **MAN/AUTO**: shift key for manual/automatic measuring range selection  
 △ Increase parameter values  
*Operating mode menu: selection of indiv. menu entries against direction of flow*
- 3 **ON / OFF | LIGHT**: key for switching device and display illumination on and off
- 4 **FUNC | ENTER** Multifunction key  
*Operating mode menu: acknowledge entry (ENTER)*
- 5 ▷ Increase measuring range or move decimal point to the right (MAN function)  
 Power measurement: change displayed unit of measure
- 6 **Rotary switch** for meas. functions (see significance of symbols on page 13)
- 7 DKD calibration mark
- 8 Connector socket for ground / connected to ground
- 9 Socket connector for direct current measurement and current clamp transformer, with automatic blocking
- 10 Connector socket for voltage, resistance, temperature, diode and capacitance measurement, and current clamp sensor
- 11 **DATA/MIN/MAX**: key for freezing, comparing and deleting measured value, and for Min-Max function  
 ▽ Decrease values  
*Operating mode menu: selection of indiv. menu entries in direction of flow*
- 12 **MEASURE | SETUP**: key for switching back and forth between measuring and menu function
- 13 **ZERO | ESC**  
 Key for zero balancing  
*Operating mode menu:* Exit current menu level and return to a higher level.  
 Exit parameters entry function without saving.
- 14 ◁ Reduce meas. range or move decimal point to the left (MAN function)  
 Power measurement: change displayed unit of measure
- 15 Power pack connector jack
- 16 Infrared interface

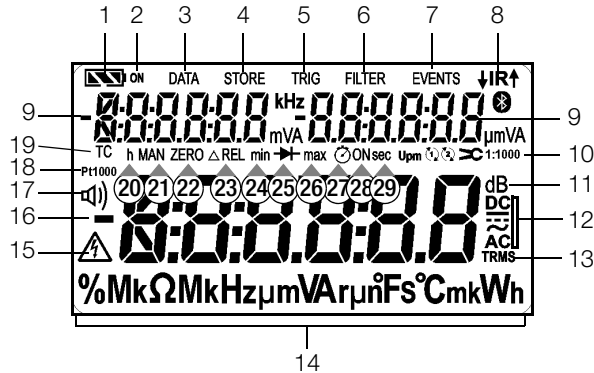



Symbols Used in the Digital Display





Battery Level Indicator

-  Battery full
-  Battery OK
-  Battery weak
-  Battery (almost) dead,  $U < 1.8\text{ V}$























Interface Indicator

-  Data transmission ↓ to / ↑ from multimeter, active
-  IR interface active (ready to receive starting commands)

- 1 Battery level indicator
- 2 ON: continuous operation (automatic shutdown deactivated)
- 3 DATA: display memory, “freeze measured value”
- 4 STORE: memory mode active
- 5 TRIG: synchronized storage
- 6 FILTER: low-pass filter active
- 7 EVENTS: events measurement
- 8 IR: infrared interface indicator
- 9 **Auxiliary display:** digital display with decimal point and polarity display
- 10 Transformation ratio (factor for current clamp sensor and transformers)
- 11 dB: alternating voltage level measurement
- 12 Selected type of current
- 13 TRMS measurement
- 14 Unit of measure
- 15 **Warning regarding dangerous voltage:**  $U > 30\text{ V AC}$  or  $U > 35\text{ V DC}$
- 16 **Main display:** digital display with decimal point and polarity display
- 17  Continuity test with acoustic signal active
- 18 Pt100/Pt1000: selected platinum resistance sensor with automatic selection of Pt100 / Pt1000
- 19 TC: temperature measurement with type K thermocouple (NiCr-Ni)
- 20 h (hours): unit of time
- 21 MAN: manual measuring range selection active
- 22 ZERO: zero balancing active
- 23 ΔREL: relative measurement with reference to offset
- 24 min: minimum value storage
- 25 Diode measurement selected
- 26 max: maximum value storage
- 27  Stopwatch active or time since beginning of measurement
- 28 ON: together with the symbol in item 27: elapsed time since activation of the respective function
- 29 sec (seconds): unit of time

## Operating Overview – Connections, Keys, Rotary Switch, Symbols

### Symbols and Functions for Rotary Switch Positions (MD: main display, AD: auxiliary display, MR: measuring range)

Switch	FUNC	Display	Measuring function	Sub-Function
V~	0/4	V~AC TRMS / HZ  A~AC TRMS (0/2)	CLiP=OFF: alternating voltage, AC TRMS, full bandwidth CLiP=ON: alternating current via current clamp sensor, TRMS AC value	DATA/MIN/MAX, MAN/AUTO, ZERO
V~	1	Hz ~AC TRMS /  (1)	CLiP=OFF: voltage frequency, to 300 kHz / CLiP=ON current frequency sensor	DATA/MIN/MAX, MAN/AUTO, ZERO
V~ 	2	V filter ~AC TRMS / Hz man	Alternating voltage, AC TRMS, with low pass filter (1 kHz)	DATA/MIN/MAX, MAN/AUTO, ZERO
dB	3	dB ~AC TRMS	Alternating voltage level measurement	DATA/MIN/MAX
V=	0/4	V= DC /  (0/2)	CLiP=OFF: direct voltage measured directly / CLiP=ON: via current clamp sensor	DATA/MIN/MAX, MAN/AUTO, ZERO
V=	1	V= DC + AC TRMS / CF /  (1)	CLiP=OFF: pulsating voltage, direct, TRMS / CLiP=ON: via current clamp sensor	DATA/MIN/MAX, MAN/AUTO, ZERO
V=	2	V= DC EVENTS	Direct voltage events	DATA/MIN/MAX, MAN/AUTO
V=	3	V~AC TRMS EVENTS	Alternating voltage events	DATA/MIN/MAX, MAN/AUTO
PQ	0/2	MAInS: V= DC + AC TRMS	Mains quality: events (type, start time, date, duration, value)	Event querying:    keys
	1	thd % ~AC TRMS / V / thd % ~AC TRMS / A /  (0/2)	Main display: total harmonic distortion relative to fundamental frequency as % Auxiliary display: RMS value for the total signal in V	Query harmonics 1 through 15: RMS values and distortion via   keys
MHz	0/2	MHz	(High) Frequency at 5 V~ up to 1 MHz	DATA/MIN/MAX, MAN/AUTO
%	1	%	Duty cycle at 5 V~	DATA/MIN/MAX
Ω	0/3	Ω	(DC) resistance	DATA/MIN/MAX, MAN/AUTO, ZERO
nS	1	nS	Conductivity (in nano-Siemens)	DATA/MIN/MAX
Ω	2	RPE Ω	Low-resistance measurement with acoustic signal where Iconst = 3 mA	DATA/MIN/MAX, ZERO
	0/2	 Ω	Continuity test, Ω, with acoustic signal where Iconst = 1 mA	DATA/MIN/MAX, ZERO
	1	 V= DC	Diode voltage up to max. 6 V where Iconst = 1 mA	DATA/MIN/MAX
Temp. TC	0/2	°C, type K	Temperature, type K thermocouple	DATA/MIN/MAX
Temp. RTD	1	°X, Pt100	Temperature with Pt100 / Pt1000 resistance sensor	DATA/MIN/MAX, MAN/AUTO, ZERO
	0/2	nF	Capacitance	DATA/MIN/MAX, MAN/AUTO, ZERO
m	1	km	Cable length	DATA/MIN/MAX, MAN/AUTO, ZERO
W	0/2	W= DC + AC TRMS / V+A / PF	Power (active, reactive, apparent power) / voltage + current / power factor	DATA/MIN/MAX, MAN/AUTO, W – VA – VAR: vw
Wh	1	Wh= DC + AC TRMS energy time	Energy: energy (active, reactive, apparent energy) / on-time Mean: average power / max: maximum power	MAN/AUTO, Wh – VAh – VARh: vw keys Energy – Mean – max:  , ZERO = reset
A=	0/4	A= DC + AC TRMS /  (2)	CLiP=OFF: pulsating current, direct, TRMS AC+DC, CLiP=ON: current clamp transformer	DATA/MIN/MAX, MAN/AUTO, ZERO
A=~/	1	A= DC /  (3)	CLiP=OFF: direct voltage, direct, CLiP=ON: direct voltage via current clamp trans.	DATA/MIN/MAX, MAN/AUTO, ZERO
A~	2	A~AC TRMS / Hz /  (0/4)	CLiP=OFF: alternating current direct, TRMS AC / current frequency, CLiP=ON: alternating current via current clamp trans. // temperature: MB 6 A and 10 A	DATA/MIN/MAX, MAN/AUTO, ZERO
A=~/	3	thd % ~AC TRMS / A (1)	Main display: total harmonic distortion relative to fundamental frequency as % Auxiliary display: RMS value for the total signal in A	Query harmonics 1 through 15: RMS values and distortion via   keys

## User Interface Symbols in the Following Sections

- ▷ ... ▷ Scroll through main menu
- ▽ ... ▽ Scroll through submenu
- ◁ ▷ Select decimal point
- △ ▽ Increase/decrease value
- b* *FE* Submenu/parameter (7-segment font)
- lfo* Main menu (7-segment font, boldface)

## Symbols on the Device

 Warning concerning a source of danger (attention: observe documentation!)

 Ground

**CAT III / IV** Measuring category III or IV device, see also “Measuring Categories and their Significance per IEC 61010-1” on page 7

 Continuous, doubled or reinforced insulation

 EC mark of conformity

 **IR** ▽ Position of the infrared interface, window on the top of the instrument



See also section 3.1 regarding location of the power pack adapter socket.

 Fuse for current measuring ranges, see section 9.3

 This device may not be disposed of with the trash.

Calibration seal (red seal):

<b>B0730</b>	Consecutive number
<b>DKD-K</b>	German Calibration Service – calibration laboratory
<b>19701</b>	Registration number
<b>10-02</b>	Date of calibration (year – month)

See also “Recalibration” on page 87.

### 3 Initial Start-Up

#### 3.1 Inserting Batteries or Rechargeable Batteries

*Be certain to refer to section 9.2 regarding correct battery installation.*

Momentary battery voltage can be queried in the Info menu (see section 6.3).

---



#### Attention!

Disconnect the instrument from the measuring circuit before opening the battery compartment lid in order to replace the batteries.

---

#### Operation With Power Pack (not included, see section 10.3)

Installed batteries are disconnected electronically if the NA X-TRA power pack is used, and need not be removed from the instrument. If rechargeable batteries are used, they must be recharged externally.

If the external power supply is switched off, the device is switched to battery operation without interruption.

#### 3.2 Switching the Instrument On

##### Switching the Instrument On Manually

- ⇨ Press the **ON / OFF | LIGHT** key until the display appears. Power-up is acknowledged with a brief acoustic signal. As long as the key is held depressed, all of the segments at the liquid crystal display (LCD) are illuminated. The LCD is depicted on page 11. The instrument is ready for use as soon as the key is released.

#### Display Illumination

After the instrument has been switched on, background illumination can be activated by briefly pressing the **ON / OFF | LIGHT** key. Illumination is switched back off by once again pressing the same key, or automatically after approximately 1 minute. If necessary, automatic deactivation of background illumination can be disabled with the appropriate parameter setting (see bLIghT parameter in SYStEM submenu) or via the interface.

#### Switching the Instrument On with a PC

The multimeter is switched on after transmission of a data block from the PC, assuming that the “r5Lb” parameter has been set to “on” (see section 6.4).

**However, we recommend using the power saving mode: “oFF”.**

---



#### Note

Electrical discharge and high frequency interference may cause incorrect displays to appear, and may disable the measuring sequence.

**Disconnect the device from the measuring circuit.** Switch the instrument off and back on again in order to reset. If the problem persists, briefly dislodge the battery from the connector contacts (see also section 9.2).

---

#### 3.3 Setting the Operating Parameters

##### Setting Time and Date

See the “t, nE” and “dRLE” parameter in section 6.4.

### 3.4 Switching the Instrument Off

#### Switching the Instrument Off Manually

⇨ Press the **ON / OFF | LIGHT** key until *OFF* appears at the display.

Shutdown is acknowledged with a brief acoustic signal.

If hazardous contact voltage has been detected (HV symbol appears), the instrument cannot be switched off.

#### Automatic Shutdown



The instrument is switched off automatically if the measured value remains unchanged for a long period of time (maximum measured value fluctuation of approx. 0.8% of the measuring range per minute or 1°C or 1°F per minute), and if none of the keys or the rotary switch have been activated before a selected period of time in minutes has elapsed (see “*APdFF*” parameter on page 64). Shutdown is acknowledged with a brief acoustic signal.

Automatic shutdown is disabled in the following operating modes: continuous operation, mains analysis, power or energy measurement and whenever dangerous contact voltage has been detected (exception: memory mode).

#### Disabling Automatic Shutdown

The instrument can be set to continuous operation.

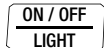
⇨ Simultaneously press the

 and  keys to this end.

The “Continuous On” function is indicated at by means of the **ON** display to the right of the battery symbol.

**The “Continuous On” setting can only be canceled by changing the respective parameter (see “*APdFF*” on page 64 regarding instrument shutdown via parameter) or by switching the instrument off manually.**

**In this case, the parameter is reset to 10 minutes.**

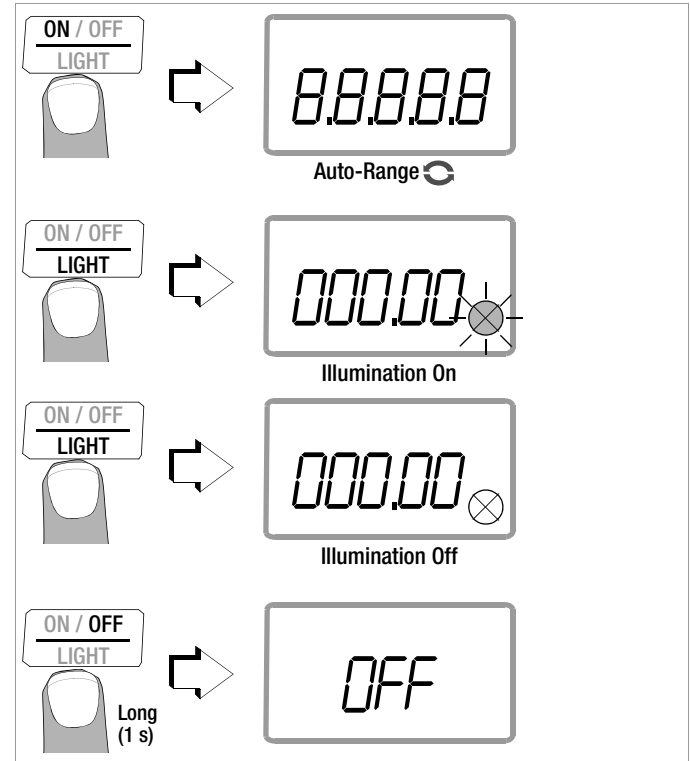

## 4 Control Functions

### 4.1 Selecting Measuring Functions and Measuring Ranges

The rotary switch is linked to an automatic socket blocking mechanism which only allows access to two jacks per function (exception: the voltage jack is open during current measurement, but a visible red ring warns the user of possible incorrect connection). Be certain to remove the appropriate plug from its respective jack before switching to and from the “A” functions. The socket blocking mechanism prevents the user from inadvertently turning the selector switch to impermissible functions after the measurement cables have been plugged in to the instrument.

#### Presence of Dangerous Contact Voltages

If dangerous voltages are applied in the high-impedance voltage measuring functions (switch position V or PQ), switching to low-impedance measuring functions (switch position MHz,  $\Omega$ , continuity, temperature or capacitance) causes “HiVoLt” to appear at the display and the respective measurement is disabled. The measuring function is not switched until dangerous contact voltage is no longer applied to the input.

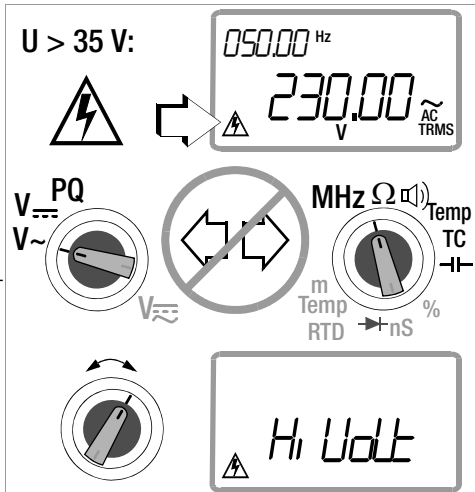

If the instrument switches itself off in the event that hazardous contact voltage is applied (during memory mode operation with large sampling period), the high-voltage warning symbol remains visible at the display.

#### 4.1.1 Automatic Measuring Range Selection (auto-ranging)

The multimeter is equipped with auto-ranging for most measuring functions. Auto-ranging is active as soon as the instrument is switched on. The instrument automatically selects the measuring range which allows for highest possible resolution of the applied quantity. When the instrument is switched to frequency measurement, the previously selected voltage measuring range remains active.

#### AUTO-Range Function

The multimeter is switched automatically to the next higher range at  $\pm(6\ 1000\ d + 1\ d \rightarrow 06\ 100\ d)$  and to the next lower range at  $\pm(05400\ d - 1\ d \rightarrow 53999\ d)$ .

*Exceptions: capacitance and cable length measurement*

The multimeter is switched automatically to the next higher range at  $\pm(6\ 100\ d + 1\ d \rightarrow 006\ 10\ d)$  and to the next lower range at  $\pm(0540\ d \rightarrow 5399\ d)$ .

#### 4.1.2 Manual Measuring Range Selection

Auto-ranging can be deactivated and measuring ranges can be selected manually in accordance with the following table by pressing the **MAN / AUTO** button. The desired measuring range can then be selected with the  $\triangleleft$  or  $\triangleright$  scroll key (exceptions: power and energy measurement, see next page).

The instrument is automatically returned to automatic range selection when the **MAN / AUTO** key is pressed, the rotary switch is activated or the instrument is switched off and back on again.

### Overview: Auto-Ranging and Manual Range Selection

	Function	Display
<b>MAN / AUTO</b>	Manual mode active: utilized measuring range is fixed	MAN
◁ or ▷	Range switching sequence for: <b>V DC:</b> 60 mV* ↔ 600 mV* ↔ 6 V ↔ 60 V ↔ 600 V <b>V AC/AC+DC:</b> 600 mV* ↔ 6 V ↔ 60 V ↔ 600 V <b>Hz (V AC):</b> 600 Hz ↔ 6 kHz ↔ 60 kHz ↔ 600 kHz <b>MHz</b> 600 Hz ↔ 6 kHz ↔ 60 kHz ↔ 600 kHz ↔ 1 MHz <b>Ω:</b> 600 W ↔ 6 kW ↔ 60 kW ↔ 600 kW ↔ 6 MW ↔ 60 MW <b>A:</b> 600 mA ↔ 6 mA ↔ 60 mA ↔ 600 mA ↔ 6 A ↔ 10 A (16 A) <b>Hz (A AC):</b> 600 Hz ↔ 6 kHz ↔ 60 kHz ↔ 600 kHz <b>F:</b> 60 nF ↔ 600 nF ↔ 6 mF ↔ 60 mF ↔ 600 mF <b>m:</b> 6 km ↔ 60 km	MAN
<b>MAN / AUTO</b>	Return to automatic measuring range selection	—

\* Via manual measuring range selection only

### “Intelligent” MAN Function

If a small measurement value occurs, the instrument can be switched to a measuring range with higher resolution by pressing the **MAN / AUTO** key.

### Power and Energy Measurements

In the power measurement function of **Metrahit Energy**, you can choose between automatic measuring range selection or fixed voltage and current measuring ranges.

In contrast to the other measuring functions, however, manual measuring range selection is not possible in this case, as the instrument cannot distinguish whether the voltage or current measuring range is to be changed. The practical procedure is therefore to start by applying the highest anticipated voltage and

current values in the case of automatic measuring range selection and then to lock in the resulting measuring ranges by pressing the **MAN / AUTO** key. Locking is disabled by pressing the key once again.

The voltage and current measuring ranges can be selected individually when the multimeter is remote-controlled via its IR interface by using the USB X-TRA adapter (and the METRAWin 10-Hit software or control command via terminal program).

### Mains and Harmonic Analysis

The measuring range for mains analysis (switch position PQ) is specified in the menu (Set > MAINS > rAnGE).

The measuring range for harmonic analysis can be selected as a fixed setting in the menu (Set > HARm > U.rAnGE and Set > HARm > I.rAnGE, clamp factor is not taken into consideration!), or auto-ranging can be activated.

#### 4.1.3 Peak Value Monitoring for Automatic and Manual Measuring Range Selection

The peak value is measured in addition to RMS measurement in the V / A DC, AC and AC+D functions, as well as for power measurement. If the peak value exceeds the valid range of the corresponding measuring path, the instrument is switched up one range, even if the displayed measured value has not yet reached the threshold value. If the momentary range is manually selected, (-)OL is displayed.

This assures that, in these functions, measurement is always performed in the correct range (e.g. during measurement of a signal with a high crest factor or measurement of the DC component of a mixed signal with a large AC component).

### 4.1.4 Quick Measurements (MAN or DATA function)

Measurements performed using a suitable fixed measuring range are executed more quickly than those which utilize automatic range selection. Quick measurement is made possible with the following two functions:

- **Manual measuring range selection**, i.e. selection of the measuring range with the best resolution (see section 4.1.2)

or

- With the **DATA function** (see section 4.4) In this way, the appropriate measuring range is selected automatically after the first measurement and the second measurement is executed more quickly.

The selected measuring range remains active for the subsequent series of measurements with these two functions.

### 4.2 Zero Offset / Relative Measurements – ZERO/Delta REL Function

Zero offset or a reference value for relative measurements can be stored to memory depending upon deviation from the zero point:

Deviation from Zero Point – with short-circuited measurement cables for V, $\Omega$ , R <sub>PE</sub> , $\square$ , A – with open input for capacitance unit of measure (F)	Display
±(0 ... 200) digits	ZERO ΔREL
±(200 ... 25000) digits (10 A measuring range: up to 5000 digits)	ΔREL

The relevant reference or correction value is deducted individually for the respective measuring function as an offset from all future measurements and remains in memory until deleted, or until the multimeter is switched off.

Zero balancing and reference value adjustment can be used for auto-ranging, as well as for manual measuring range selection.

#### Zero Balancing

- ⇒ Plug the measurement cables into the instrument and connect the free ends to each other, except for capacitance measurement in which case the ends of the cables are not connected to each other.
- ⇒ Briefly press the **ZERO | ESC** key.  
The instrument acknowledges zero balancing with an acoustic signal, and the “ZERO ΔREL” symbol appears at the LCD. The value measured at the moment the key is pressed serves as a reference value.
- ⇒ Zero balancing can be cleared by once again pressing the **ZERO | ESC** key.



### Setting the Reference Value

- ⇨ Plug the measurement cables into the instrument and measure a reference value (max. 25,000 digits, or 5000 digits in 10 A range)
- ⇨ Briefly press the **ZERO | ESC** key.  
The instrument acknowledges storage of the reference value with an acoustic signal, and the “ZERO ΔREL” or the “ΔREL” symbol appears at the LCD. The value measured at the moment the key is pressed serves as a reference value.
- ⇨ The reference value can be cleared by once again pressing the **ZERO | ESC** key.

### Notes Regarding Relative Measurement

- Relative measurement effects the main display only.
- In the case of relative measurement,  $\Omega$ , F or AC quantities may also appear as negative values.

### 4.3 Display (LCD)

#### Measured Value, Unit of Measure, Type of Current, Polarity

The measured value with decimal and plus or minus sign appears at the digital display. The selected unit of measure and current type are displayed as well. A minus sign appears to the left of the value during the measurement of zero-frequency quantities, if the plus pole of the measured quantity is applied to the “ $\perp$ ” input.

#### Overranging

“ $\overline{0}$ ” (overload) is displayed as of 61,000 digits.

Exceptions: “OL” appears at the display as of 6100 digits for measuring functions with a measuring range span of 6000 digits.

## 4.4 Measured Value Storage: DATA (auto-hold / compare)

An individual measured value can be automatically “frozen” with the DATA function (auto-hold). This is useful, for example, when contacting the measuring points with the test probes requires your full attention. After the measuring signal has been applied and the measured value has settled in accordance with the “condition” listed in the table below, the measured value is frozen at the digital display and an acoustic signal is generated. The test probes can now be removed from the measuring points, and the measured value can be read from the digital display. If the measuring signal falls below the value specified in the table, the function is reactivated for storage of the next value.

### Measured Value Comparison (DATA compare)

If the currently frozen value deviates from the first saved value by less than 100 digits, the acoustic signal is generated twice. If deviation is greater than 100 digits, only a brief acoustic signal is generated.



#### Note

The selected measuring range cannot be manually changed as long as the DATA function is active.

The DATA function is deactivated by pressing and holding the **DATA/MIN/MAX** key (approx. 1 second), when the measuring function is changed, or when the instrument is switched off and back on again.

### DATA Function in Memory Mode Operation (rAtE parameter = dAtA)

If dAtA is selected as the storage rate under the StorE > rAtE measuring parameter setting, and if memory mode operation is then started, measured values “frozen” with activated DATA function are automatically saved to permanent memory with time stamp.

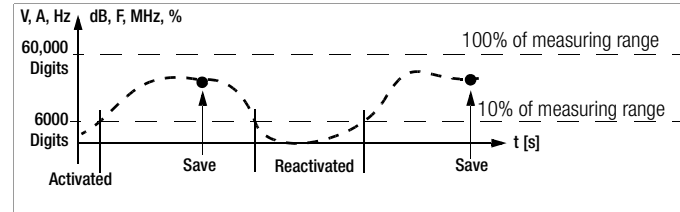

Function DATA	Data/ Min/Max Key	Condition		Response from Instrument		
		Measuring Function	Measuring Signal	Display Digital MV	DATA	Acous- tic
Activate	Brief				Blinks	Once
Save (stabilized measured value)		V, A, Hz, dB, F, MHz, %	> 10% rdg.	Is dis- played	Static	Once Twice <sup>2</sup>
		$\Omega \rightarrow \rightarrow$	$\neq \Omega$			
Reactivate <sup>1)</sup>		V, A, Hz, dB, F, MHz, %	< 10% rdg.	Stored MV	Blinks	
		$\Omega \rightarrow \rightarrow$	$= \Omega$			
Change to Min/Max	Brief	See table in section 4.4.1				
Exit	Long			Is deleted	Is deleted	Twice

<sup>1</sup> Reactivation results from falling short of specified measured value limits.

<sup>2</sup> Two acoustic signals are generated the first time a measured value is saved as a reference value. For subsequent data hold, two acoustic signals are only generated if the currently frozen value deviates from the **first** saved value by less than 100 digits.

Key: MV = measured value, MR = measuring range

**Example**

The voltage measuring range is set manually to 6 V. The first measured value is 3 V and is stored to memory because it is greater than 10% of the measuring range (6000 digits = 0.6 V), and is thus reliably above the background noise level. As soon as the measured value drops to less than 10% of the measuring range (6000 digits), i.e. amounts to less than 6 V which corresponds to removal of the test probes from the measuring point, the instrument is ready to store a new value.

**4.4.1 Saving Minimum and Maximum Values – Min/Max Function**

Minimum and maximum measured values applied to the measuring instrument's input after the Min-Max function has been activated can be "frozen" at the auxiliary display along with time of occurrence. The most important use of this function is the determination of minimum and maximum values during long-term measured value observation.

Except during power measurement, the Min-Max function has no effect on the main display, at which the current measured value continues to appear.

Apply the measured quantity to the instrument and set the measuring range with the **MAN / AUTO** key before activating the Min-Max function.

The Min-Max function is deactivated by pressing and holding the **DATA/MIN/MAX** key (approx. 1 second), when the measuring function is changed, or when the instrument is switched off and back on again.

**Note**

Extreme values can be reset by pressing the ZERO key.

Min-Max Function	Data/Min/Max Key	Min. and Max. Measured Values	Response from Instrument		
			Display Digital Measured Value	Max. Min.	Acoustic Signal
1 Activate and save	<b>DATA/MIN/MAX</b> 1 x brief	Are saved	Current measured value		Once
2 Save and display	<b>DATA/MIN/MAX</b> Brief	Storage continues in the background, new min. and max. values are displayed together with time.	Saved min. value	Min.	Once
	Brief		Saved max. value	Max.	Once
Reset	<b>ZERO/ESC</b> Brief	Are deleted	Saved min.-max. values	min/max	1
Stop	<b>DATA/MIN/MAX</b> Long	are deleted and function is exited	Current measured value	Is deleted	Twice

**Power Measurement (special case)**

Instantaneous power is displayed with the switch in the **W** setting. The Min-Max function is activated with the **DATA/MIN/MAX** key. The minimum and maximum values for active, reactive and apparent power are displayed as of the beginning of the power measurement, along with time of occurrence (date and time). Previous Min-Max values can be cleared without exiting the function by pressing the ZERO key.

This function differs from the general Min-Max function insofar as measurement is performed continuously in the background, even if the Min-Max display is not shown, and while the instrument is in the energy measuring mode

### 4.5 Measurement Data Recording – Memory Mode Operation, STORE Menu Function

The system multimeter is capable of recording measurement data using an adjustable sampling rate for long periods of time in the form of measurement series. Data are stored to permanent memory, an68: EnErGY Submenud are retained even after the multimeter is switched off, as well as after battery replacement.

Stored measured values can subsequently be read out at the computer. The only prerequisite is a PC which is connected by means of an interface cable to the USB X-TRA bidirectional interface adapter, which is plugged onto a system multimeter. See also section 7, "Interface Operation".

#### Memory Parameters Overview



Parameter	Page: Header
<i>CLEAR</i>	23: Clear Memory
<i>dENAnd b rAE</i>	66: tEMP unit – Select a Unit of Measure for Temperature
<i>EMPTY</i>	23: Clear Memory – appears after <i>CLEAR</i>
<i>HYSL</i>	73: HYSL – Hysteresis (parameter for memory mode operation)
<i>OCCUP</i>	23: Querying Memory Occupancy
<i>rALE</i>	68: EnErGY Submenu
<i>StArE</i>	22: Starting Recording via Menu Functions
<i>StoP</i>	23: Ending Recording
<i>EStorE</i>	74: tStorE – Recording Time (parameter for memory mode operation)

#### Preparing for Recording – Parameter Settings

- First set the **sampling rate** for memory mode operation (see section 6.4 the *rALE* parameter).
- Set hysteresis for efficient use of available memory space. During memory mode operation, new measured data are only saved if they deviate from the previously stored value by an amount which exceeds the selected hysteresis value (see section 6.4, "*HYSL*" parameter).
- Set "*t.StorE*" in order to limit recording duration.
- First select the desired measuring function and an appropriate measuring range.
- Check the battery charge level before starting long-term measurement recordings (see section 6.3).  
Connect the NA X-TRA power pack if applicable.

#### Starting Recording via Menu Functions

- Switch to the "*SEL*" mode by pressing **MEASURE | SETUP** and select the "*StorE*" menu.

 *Info* ▷ ... ▷ *StorE*  *StorE* OFF *StArE* (blinks)

 *StorE*

- Memory mode operation is started by acknowledging the blinking "*StArE*" prompt at the main display with the **FUNC | ENTER** key. The **STORE** display segment appears in the header and indicates that the memory mode has been activated. "*StorE*" APPEARs at the main display.
- Press the **MEASURE | SETUP** key in order to return to the measuring function.

**Note**

The StorE > StArt and StorE > CLEAR menu functions can only be selected as long as memory is not completely full (StorE > StArt), or not completely empty (StorE > CLEAR).

**Ending Recording**

- ◇ If the instrument is in the measuring mode, return to the menu function by pressing the **MEASURE | SETUP** key. Select “**StorE**” again and acknowledge by pressing the **FUNC | ENTER** key. “**StorE**” blinks at the main display.

StorE on **StorE**  StorE

- ◇ Acknowledge the “**StorE**” display by pressing **FUNC | ENTER**. The **STORE** display segment in the header is cleared, indicating that recording has been ended.
- ◇ Press the **MEASURE | SETUP** key in order to return to the measuring function.
- ◇ Memory mode operation can also be exited by switching the multimeter off.

**Querying Memory Occupancy**

Memory occupancy can be queried during recording with the help of the “**Info**” menu (see also section 6.3). Memory occupancy range: 000. % to 099.9%.

 **Info**  bAtt:xxV ▾ ... ▾ OCCUP: 0 17.4 %

**Clear Memory**

This function deletes all measured values from memory! (*blinks*) It's advisable to execute this function before starting a new measurement data recording.

 **Info** ▷ ... ▷ **StorE**  StorE off **StArt** (*blinks*)

▷ StorE CLEAR no ▷ **YES**  EMPTY → StorE

**Storage of Individual Values Using the SAMPLE or dAtA Sampling Rate**

If only individually selected values need to be saved, the **SAMPLE** value must be selected as the StorE > rAtE sampling value. If memory mode operation is then started, a single measured value is saved to permanent memory with time stamp when the **DATA/ MIN/MAX** key is pressed and held until two rapidly repeating acoustic signals are generated (not in the case of mains analysis). If **dAta** is selected as the StorE > rAtE sampling rate, and if memory mode operation is then started, measured values ascertained with activated DATA function are automatically saved to permanent memory with time stamp.

### 4.5.1 Rapid Momentary Value Acquisition for U DC and I DC

Rapid momentary value acquisition is only activated during memory mode operation in the U DC and I DC functions, and only after selecting a sampling period of 0.5, 1, 2, 5, 10, 20 or 50 ms: All trigger and hysteresis functions are available, although the momentary value is acquired with a separate measuring circuit. This allows for the recording of the waveshapes of low-frequency **signals with reduced resolution and accuracy** (typically < 1% of the measuring range under reference conditions, not specified). Roughly 300,000 measured values can be saved in this mode. Values of up to about 1.9 x U<sub>max</sub> or I<sub>max</sub> are recorded (with fixed range, range-dependent fluctuations), and thus the range limit can be exceeded by approximately 90%.



#### Note

The ZERO/ $\Delta$ REL function is not taken into consideration for rapid momentary value acquisition!

---

### 4.5.2 Power and Energy Measurement in the Memory Mode

The value selected for the SEt > EnErGY > StorE menu parameter specifies which values from power and energy measurements will be saved during memory mode operation:

- SEt > EnErGY > StorE = **normal** (default setting):  
**Momentary values** for current, voltage, active, reactive and apparent power, as well as power factor, are acquired and saved to memory at the selected sampling rate (at least 0.5 s).
  - SEt > EnErGY > StorE = **demand**:  
The instrument only saves mean power values **at the end of the** dEMAnd tiME observation period (see section 6.4.4, “dEMAnd tiME” parameter).
  - SEt > EnErGY > StorE = **all**:  
Momentary values are saved at the selected sampling rate and mean power values are saved at the end of each dEMAnd tiME observation period (see section 6.4.4, “dEMAnd tiME” parameter).
- Set the dEMAnd tiME interval for memory mode operation before you start recording.

## 5 Measurements

### 5.1 Voltage Measurement

#### Notes Regarding Voltage Measurement

- **The multimeter may only be operated with installed batteries or rechargeable batteries. Dangerous voltages are otherwise not indicated, and the instrument may be damaged.**
- The multimeter may only be operated by persons who are capable of recognizing **contact hazards** and taking the appropriate safety precautions. Contact hazards exist anywhere, where voltages of greater than 33 V (RMS) may occur. The test probes may only be only gripped up to the finger guard. Do not touch the metallic test probes under any circumstances.
- Avoid working alone when taking measurements which involve **contact hazards**. Be certain that a second person is present.
- **Maximum permissible voltage** between the connector sockets, (9 and 10) and ground (8) is 600 V for measuring category III and 300 V for measuring category IV. An acoustic signal is generated at a display value of greater than 600.0 V in the 600 V range (intermittent acoustic signal: 250 ms on, 250 ms off).
- **Power limiting:** <math>6 \times 10^6</math> Volts x Hertz.
- Be prepared for the occurrence of **unexpected voltages** at devices under test (e.g. defective devices). For example, capacitors may be dangerously charged.
- No measurements may be made with this instrument in electrical circuits with corona discharge (high-voltage).
- Special care is required when measurements are made in HF electrical circuits. Dangerous pulsating voltages may be present.

- **Be aware of the fact that dangerous voltage spikes are not displayed during measurement with the low-pass filter. We recommend measuring voltage without the low-pass filter first, in order to be able to detect any dangerous voltages.**
- Be absolutely certain that the measuring ranges are not overloaded beyond their allowable capacities. Limit values are included in section 8, "Technical Data", in the table entitled "Measuring Functions and Measuring Ranges" in the "Overload Capacity" column.
- With the rotary switch in the V position, the instrument is always in the 6 V measuring range immediately after it's switched on. As soon as the **MAN / AUTO** key is pressed, and assuming the measured value is less than 600 mV, the instrument is switched to the mV measuring range.

#### Scope of Functions, Voltage Measurement

Function	
V AC / Hz TRMS, dB ( $R_i \geq 9 \text{ M}\Omega$ ) <sup>1</sup>	•
V AC / TP-Filter 1 kHz <sup>1</sup> ( $R_i \geq 9 \text{ M}\Omega$ ) TRMS	•
V AC+DC TRMS ( $R_i \geq 9 \text{ M}\Omega$ )	•
V DC ( $R_i \geq 17 \text{ M}\Omega$ )	•
MHz at 5 V AC	•
Duty cycle as %	•
Frequency bandwidth	100 kHz

<sup>1</sup> A 1 kHz low-pass filter can be used in this case, in order to filter out high frequency pulses of greater than 1 kHz, for example when performing measurements at pulsed motor drives.

### 5.1.1 Direct Voltage, Pulsating Voltage and Crest Factor Measurement – V DC, V (DC+AC) and CF

#### Note

Set the  $CL, P$  parameter to **OFF** in the current clamp setup menu. Otherwise all measured values are displayed in amperes, corrected by the amount resulting from the selected transformation ratio for an interconnected current clamp sensor. The clamp symbol is also displayed. Refer to section 6.4, "Entering Parameters – SETUP Menu", regarding adjustment.

- In accordance with the voltage to be measured, turn the rotary switch to  $V_{DC}$  or  $V_{DC+AC}$ .
- Connect the measurement cables as shown. The "⊥" connector jack should be grounded.

#### Note

An intermittent acoustic signal warns the operator if the measured value exceeds the upper range limit in the 600 V range.

Make sure that a current measuring range ("A") has not been activated when the multimeter is connected for voltage measurement! If the fuse's blowing limits are exceeded as a result of operator error, both the operator and the instrument are in danger!

With the rotary switch in the V position (auto-ranging), the multimeter is always in the 6 V measuring range immediately after it's switched on. As soon as the **MAN / AUTO** key is pressed, and assuming the measured value is less than 600 mV, the instrument is switched to the 600 mV measuring range. Press the  $\triangleleft$  key in order to switch to the 60 mV measuring range.

$CL, P = OFF!$

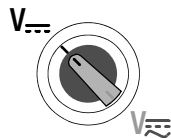

Measuring ranges:

$V_{DC}$ : 60 mV ... 600 V

$V_{DC+AC}$ : 600 mV ... 600 V

CF: 1.0 ... 11.0

max. 600 V (< 10 kHz)

max. 100 V (> 10 kHz)

$P_{max} = 6 \times 10^6 \text{ V} \times \text{Hz}$

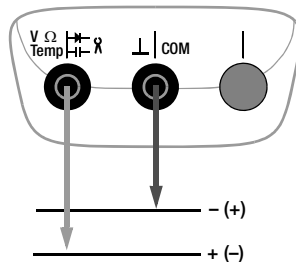

Warnings regarding dangerous voltage:

> 30 V AC or > 35 V DC:

> 600 V:

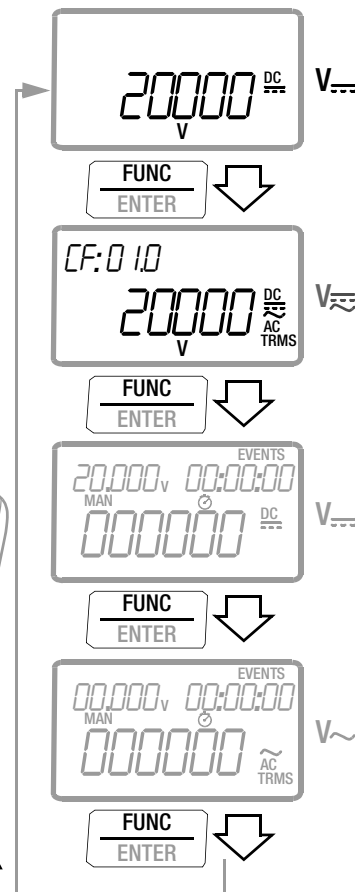





**Note**

**60 mV range:**

Thermovoltages occur in the event of temperature fluctuation, which appear as additional voltage offset. It may be necessary to repeat zero offsetting in order to achieve the specified degree of accuracy.

**Crest Factor Display**

Crest factor is displayed for voltages in the V (AC+DC) function along with the measured voltage value. The voltage value is measured simultaneously in a separate measuring circuit to this end, and crest factor is displayed within a range of 1.0 to 11.0.

This value indicates the quality of the applied signal. The only prerequisite is a periodic signal with a valid frequency (see table).

Measuring range:  $1.0 \leq CF \leq 11.0$ ; resolution: 0.1

Typical (not specified) maximum deviation  
for  $U \geq 5\%$  of the measuring range:

Frequency	$CF \leq 3.0$	$3.0 < CF \leq 5.0$	$5.0 < CF \leq 10.0$
10 to 70 Hz	$\pm 02$	$\pm 02$	$\pm 05$
70 to 440 Hz	$\pm 02$	$\pm 05$	Not valid
440 Hz to 1 kHz	$\pm 05$	Not valid	Not valid
> 1 kHz:	Not valid	Not valid	Not valid

### Events Recording “EVENTS”

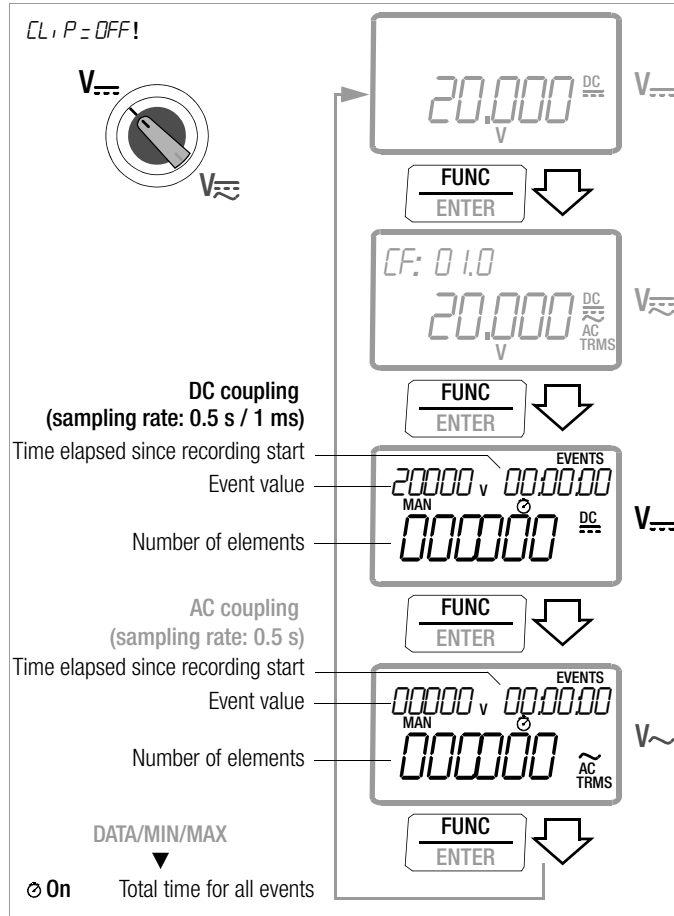

Events recording can be activated with DC or AC coupling in the V DC switch position. The auto-ranging function is deactivated, and the respective valid measuring range must be selected manually in the left-hand auxiliary display.

The following can be measured and displayed:

- Number of events  
*An event is recorded whenever at least 1 measured value has fallen short of the L-trig threshold **and** subsequently at least 1 measured value has exceeded the H-trig threshold.*  
Voltage signals with a repetition frequency of less than 500 Hz or 2 Hz are recorded (event rate or period of 0.001 s or 0.5 s).
- Total time for all events  
*Time during which measured voltage was above the upper trigger threshold.*
- Total time elapsed since event recording was started

### Event Recording Parameter with DC Coupling – DC Sampling Rate

- Enter the desired sampling rate in the parameter settings menu:

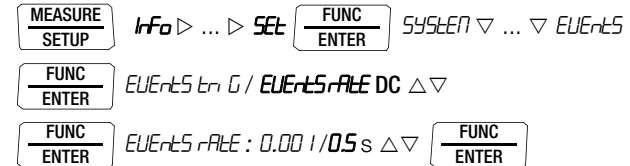



**Note**

1 ms sampling is executed with reduced resolution and accuracy (approx. 1% of the measuring range under reference conditions).

**Events Measurement Parameter – Trigger Thresholds**

- Enter upper threshold *H-trig* and lower threshold *L-trig* in digits in the parameter settings menu (see table with examples below):

**MEASURE SETUP** Info ▷ ... ▷ **Set** **FUNC ENTER** SYSTEM ▾ ... ▾ **EVENTS**

**FUNC ENTER** EVENTS RATE DC / **EVENTS tr G** Δ ▾

**FUNC ENTER** H-trig SET: -60000 ... +60000 Δ ▾

**FUNC ENTER** L-trig SET: -60000 ... +60000 Δ ▾ **FUNC ENTER**

**Examples of Trigger Threshold Entries**

Meas. range	Entered Value: H-trig or L-trig Trigger Threshold in Digits		
	20 000	02 000	00 200
	Effective trigger threshold		
600 mV	200 mV	20 mV	2 mV
6 V	2 V	200 mV	20 mV
60 V	20 V	2 V	200 mV
600 V	200 V	20 V	2 V

**Selecting the Measurement**

- In accordance with the voltage to be measured, turn the rotary switch to V<sub>≐</sub> or V<sub>≐̄</sub>.
- Manually select the measuring range for the event value in the left-hand auxiliary display.
- Apply the signal as you would for a voltage measurement.
- Repeatedly press the multifunction key (**FUNC | ENTER**) until EVENTS (DC) or EVENTS (AC) appears at the display.

You can switch back and forth between two times with the **DATA/ MIN/MAX** key:

- Total time elapsed since event recording was started
- Total time of all events (voltage above H-trig)

## 5.1.2 Alternating Voltage and Frequency Measurement V AC and Hz with Selectable Low-Pass Filter, V AC + FILTER and dB V AC



### Note

Set the  $L, P$  parameter to **OFF** in the current clamp setup menu.

Otherwise all measured values are displayed in amperes, corrected by the amount resulting from the selected transformation ratio for an interconnected current clamp sensor. The clamp symbol is also displayed. Refer to section 6.4, "Entering Parameters – SETUP Menu", regarding adjustment.

- ⇨ In accordance with the voltage or frequency to be measured, turn the rotary switch to V~.
- ⇨ Connect the measurement cables as shown. The "L" connector jack should be grounded.

### Voltage measurement



### Note

An intermittent acoustic signal warns the operator if the measured value exceeds the upper range limit in the 600 V range.

Make sure that a current measuring range ("A") has not been activated, when the multimeter is connected for voltage measurement! If the fuse's blowing limits are exceeded as a result of operator error, both the operator and the instrument are in danger!

- ⇨ You can switch back and forth between voltage measurement with and without low-pass filter.
- ⇨ Repeatedly press the multifunction key (**FUNC | ENTER**) until the unit of measure V, or V and FILTER, appears at the display.

### Frequency Measurement

Signal frequency appears at the left-hand auxiliary display when the instrument executes alternating voltage measurements. A separate frequency measurement can be additionally performed by pressing the **FUNC | ENTER** key, which allows for use of the DATA and Min-Max functions.

If the measuring signal is too low, switch manually to a lower range.

Lowest measurable frequencies and maximum allowable voltages are listed in section 8, "Technical Data".



### Note

For measurements close to the trigger threshold: display error or zero. Select a lower voltage measuring range. In the case of measured values which are many times greater than the expected results, the input signal may be distorted. If this is the case, perform a measurement with activated 1 kHz low-pass filter.

### Measurement with Low-Pass Filter



### Attention!

Be aware of the fact that dangerous voltage spikes are not displayed during this type of measurement (see also "Voltage Comparator". We recommend measuring voltage without the low-pass filter first, in order to be able to detect any dangerous voltages.

A 1 kHz low-pass filter can be activate if required, in order to filter out high frequency pulses of greater than 1 kHz, for example when performing measurements at pulsed motor drives, i.e. undesired voltages of greater than 1 kHz can be suppressed.

The active low-pass filter is indicated by the FILTER display. The multimeter is automatically switched to manual measuring range selection.

Specified measuring accuracy is not reached with signals of greater than 100 Hz when the filter is active.

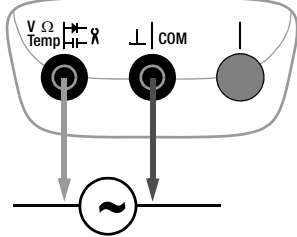

**Measuring ranges:**  
 V~: 600 mV ... 600 V  
 max. 600 V (< 10 kHz)  
 max. 100 V (> 10 kHz)  
 Hz: 1 Hz ¼ 300 kHz  
 $P_{max} = 6 \times 10^6 \text{ V} \times \text{Hz}$   
 for  $U > 100 \text{ V}$

**Warnings regarding dangerous voltage:**

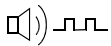
- > 30 V AC or > 35 V DC: 
- > 600 V: 

### Voltage Comparator for Displaying Dangerous Voltage

The input signal or measuring signal is checked by a voltage comparator for dangerous spikes, because these do not appear at the display when the low-pass filter is used.

At voltages of greater than 30 V AC or 35 V DC, a danger symbol appears at the display: .

CL, P = OFF!

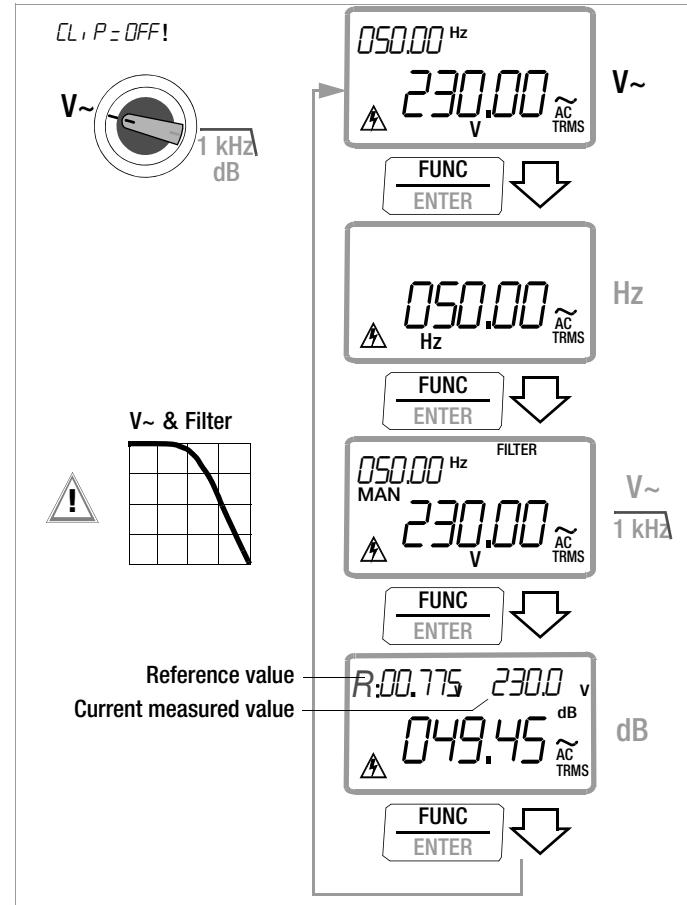

V~

1 kHz  
dB

050.00 Hz  
230.00 V AC TRMS

FUNC  
ENTER

050.00 Hz AC TRMS

FUNC  
ENTER

050.00 Hz FILTER  
MAN 230.00 V AC TRMS

V~  
1 kHz

FUNC  
ENTER

Reference value: 230.0 V  
 Current measured value: 049.45 dB AC TRMS

FUNC  
ENTER

### Alternating Voltage Level Measurement (dB)

Voltage level measurement is used in order to ascertain overall attenuation or boosting of a transmission system (shown here as a 4-pole setup).

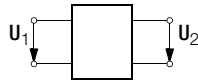

$$\text{Voltagelevel[dB]} = 20 \cdot \log \frac{U_2}{U_1}$$

Where  $U_1 = U_{\text{REF}}$  (reference level)

Result > 1: boosting

Result < 1: attenuation

- ⇨ Manually select the measuring range for the voltage amplitude. When the instrument is switched to dB measurement, the previously selected voltage measuring range remains active.
- ⇨ Repeatedly press the multifunction key **FUNC | ENTER** until the unit of measure dB appears at the display. Lowest measurable frequencies and maximum allowable voltages are included in section 8, "Technical Data".

The level measurement function is now activated. The measured value is calculated based upon the RMS value of the alternating voltage component relative to the measuring range (600 mV ... 600 V), and displayed.

The default setting for the reference level is 0 dB = 0.775 V (1 mW to 600 Ω). This value can be adjusted in the "SEL" menu (see also section 6.4):

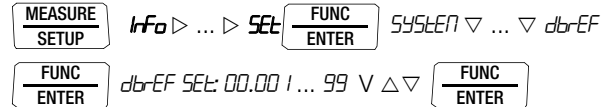

### Note

No terminal resistors have been integrated into the device. It performs measurement with a high input impedance of at least 9 MΩ (see technical data).

In order to be able to perform correct measurement at non-terminated devices under test, the terminating resistor must be connected to the terminals. Be sure to take power loss at the terminating resistor into consideration!

### 5.1.3 Mains Monitoring / Mains Disturbance Recording – PQ

#### Overview

The METRAHIT ENERGY is equipped with an operating mode for mains disturbance recording in the PQ switch position. Input voltage is simultaneously measured with a different measuring circuit to this end.

- The RMS value of the applied voltage is measured and displayed continuously. (This measurement corresponds to DC+AC TRMS measurement, see section 5.1.2.) The measurement is used for precise detection of overvoltages and undervoltages.
- Additionally, the voltage is sampled at 1.2 kS/s and a half-cycle RMS value is calculated for each half-cycle: This is used to detect short overvoltages (swells) and undervoltages (dips). Mains frequency (50 or 60 Hz) must be correctly set for this measurement (see section 6.4.5).
- Momentary values acquired by means of fast sampling are used for the detection of briefly exceeded absolute values (peaks).
- Steep voltage surges within a range of ±200 V to 1000 V relative to the momentary voltage value are additionally acquired by a sample&hold circuit.

The measuring range can be adjusted from 6 to 600 V: With the exception of transient detection (fixed range of 200 to 1000 V), all disturbances can be detected in all three voltage ranges, but only at frequencies of 0 Hz (direct voltage), 50 or 60 Hz.

#### Acquirable Mains Disturbances

The following types of disturbances are recorded:

- Undervoltage (LoVoLt) and overvoltage (HiVoLt) with start time, duration and extreme value.
- Under and overvoltage of the half-period RMS value (dips and swells) with start time, as well as minimum and maximum values.
- Momentarily exceeded values with a duration of greater than 1 ms (peak) with time of occurrence and maximum value
- Steep transients with a rise time of 0.5 to 5 ms within a range of 200 to 1000 V including time of occurrence, relative voltage value and the previous 1 ms instantaneous value

Based on the example of a 230 V, 50 Hz line voltage, the following figure depicts acquirable disturbances in addition to the detection of undervoltages and overvoltages:

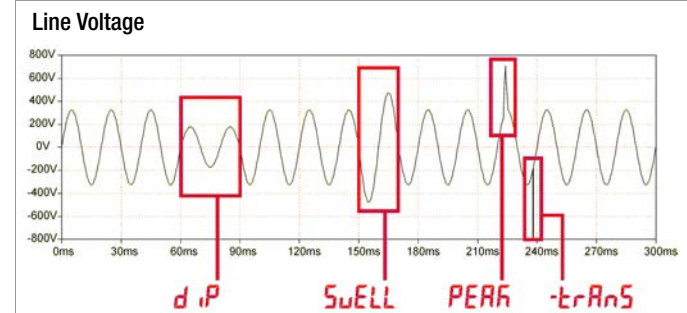

It must be noted that certain events – depending upon the threshold voltage selected for them – often occur in combination, for example the “LoVolt” event always occurs together with the “diP” event, if the same threshold voltage has been selected for both, but not the other way around.

### Parameters Configuration

Prior to mains analysis, the function's parameters have to be configured under SET > MAInS. The following parameters are available:

- **MAInS.F:** Selection of the measuring signal line frequency is required for the calculation of the TRMS half-cycle value: 50 or 60 Hz can be selected. Selection is irrelevant for DC signals.
- **rAnGE:** The 6 V, 60 V or 600 V range (default) can be selected as the voltage measuring range.
- **TRIG:** The threshold values for undervoltage (**LoVoLt LiMit**) and overvoltage (**HiVoLt LiMit**) while monitoring the TRMS voltage value can be entered here in digits. The full measuring range corresponds to 60,000 digits.
- **diP LiMit:** If the TRMS half-cycle value falls short of the specified value (in digits, 60,000 = full measuring range), a voltage drop (dip) is detected.
- **SWELL LiMit:** If the TRMS half-cycle value exceeds the specified limit, a brief overvoltage (swell) is detected.
- **PEAK LiMit:** If the momentary voltage value exceeds the value specified here (regardless of polarity), an exceeded limit value is recorded (±PEAK).
- **trAnS LiMit:** A level can be set here as of which a voltage transient is recorded. This is a polarity-independent entry relative to the momentary value. The smallest value is 200 V. Regardless of the selected measuring range, acquisition always takes place within a range of 200 to 1000 V.

Type of Disturbance	Measuring Range	Resolution	Intrinsic Uncertainty under Reference Conditions with Fixed Frequency of 50/60 Hz	Pulse Time
Over/under-voltage	6 ... 600 V	60,000 digits		
Dip/swell	6 ... 600 V	6000 digits	1% rdg. + 1% MR	≥ 1 half-cycle
Peak	6 ... 600 V	6000 digits	1% rdg. + 2% MR	≥ 1 ms
Transients *	200 ... 1000 V	10 V	± 50 V	0.5 ... 5 μs

\* Absolute value of the transients is limited to 1000 V by input protection.

### Sequence

⇒ Set the trigger values for the MAInS menu:

<b>Line frequency:</b>	<b>MAInS.F</b>
<b>Meas. range for mains disturbance recording:</b>	<b>rAnGE</b>
<b>Lower trigger threshold:</b>	<b>LoVoLt LiMit</b>
<b>Upper trigger threshold:</b>	<b>HiVoLt LiMit</b>
<b>Voltage dip limit value:</b>	<b>diP LiMit</b>
<b>Voltage swell limit value:</b>	<b>SWELL LiMit</b>
<b>Trigger for surges or voltage peaks:</b>	<b>PEAK LiMit</b>
<b>Limit value for transients:</b>	<b>trAnS LiMit</b>

See section 6.4.5, "MAInS Submenu", regarding settings.

⇒ Set the rotary switch to PQ.

⇒ Connect meas. cables same as for a voltage measurement.

Mains monitoring is started automatically as soon as the selector switch is set to PQ.

The number of recorded mains disturbances appears at the left-hand auxiliary display. Recorded events can be deleted by pressing and holding the ZERO key.



#### 5.1.4 Mains Disturbance Recording in Memory Mode Operation

If memory mode operation is started (see STORE menu function above), further data in addition to those which appear at the display are saved to memory, allowing for computer aided visual assessment:

- Regardless of which events occur, (DC+AC) TRMS voltage is continuously recorded with adjustable sampling rate, and in consideration of the selected hysteresis value.
- If a dip or a swell is recorded, the RMS half-cycle values of the 10 previous and 90 subsequent half-cycles are recorded.
- If a peak is recorded, the momentary values of the two half-periods both before and after the peak are acquired.



#### Note

Memory mode operation must be stopped before data can be read out of the instrument.

---

### 5.1.5 Harmonic Analysis (voltage measurement) $\rightarrow$

In the switch positions for the mains quality analysis  $\rightarrow$  and current measurement (A) functions, harmonic analysis is performed approximately once per second using 32 averaged sampling values per mains period (adjustable to 16.7, 50, 60 or 400 Hz, see section 6.4.6 on page 71).

FFT (fast Fourier transformation) makes oscillations up to the 15<sup>th</sup> harmonic available to this end. The RMS values of the fundamental harmonic (HD 1) and the individual higher harmonics (HD 2 through 15), as well as total harmonic distortion (THD) are calculated. RMS values and harmonic components are displayed in each case (RMS values relative to the RMS value of the fundamental harmonic). Harmonic analysis is also available for current clamp measurement.

- Set the rotary switch to PQ.
- Press the multifunction key **FUNC | ENTER**.
- Connect the measurement cables as you would for a voltage measurement.

The main display shows total harmonic distortion as a percentage, and the total RMS value of distortion appears at the right-hand auxiliary display.

- The distortion components (main display) and the RMS values of the individual harmonics (left-hand auxiliary display) can be measured by pressing the  $\Delta \nabla$  scroll keys.
- The instrument is switched directly to a display of total harmonic distortion after pressing the **ZERO | ESC** key.

### Prerequisites

The results of harmonic analysis are only valid if the following conditions are fulfilled:

- The fundamental frequency corresponds with the selected fundamental frequency.
- Only significant harmonic components occur up to the 15<sup>th</sup> harmonic (made apparent by rapidly dropping RMS value components up to the 15<sup>th</sup> harmonic).
- The AC TRMS value amounts to at least 5% of the measuring range.

### Additional Harmonic Analyses (current measurement)

For direct current measurement see section 5.8.1, for measurement with current clamp sensor see section 5.8.2 and for measurement with current clamp transformer see section 5.8.3.

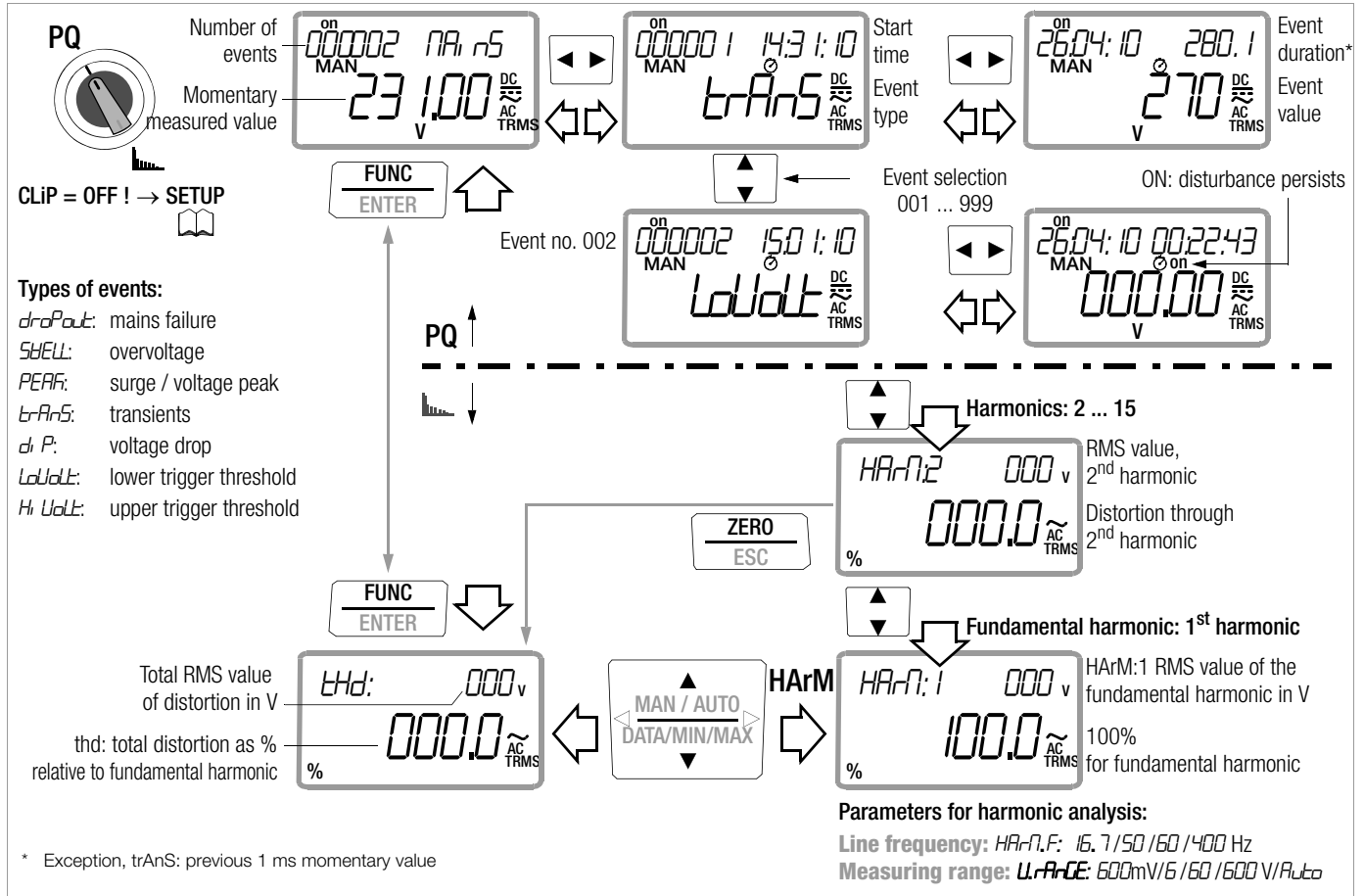

### 5.1.6 Frequency and Duty Cycle Measurement

- ⇨ Set the rotary switch to MHz or %.
- ⇨ Connect the measurement cables as shown.

Make sure that a current measuring range (“A”) has not been activated when the multimeter is connected for frequency or duty cycle measurement!



#### Attention!

The applied signal voltage may not exceed 5 V.

#### Frequency Measurement, MHz

A 5 V signal with a frequency of up to 1 MHz is measured and displayed using MHz as a unit of measure. The pulse frequency is the reciprocal value of the pulse period.

#### Duty Cycle Measurement $t_E/t_P$

The ratio of pulse duration to pulse period is measured with periodic square-cycle signals and is displayed as a percentage.

$$\text{Duty cycle (\%)} = \frac{\text{Pulse duration (} t_E \text{)}}{\text{Pulse period (} t_P \text{)}} \cdot 100$$



#### Note

The applied frequency must remain constant during duty cycle measurement.

**MHz**

1.0323 kHz

MHz  $f_P$

FUNC/ENTER

002.00%

%  $t_E/t_P$

**Pulse Time Quantities**

$f_P$  pulse frequency =  $1/t_P$

$t_E$  pulse duration

$t_P$  pulse period

$t_P - t_E$  interpulse period

$t_E/t_P$  pulse or duty cycle

**Measuring ranges:**

$f_P$  pulse frequency range

Hz	$t_E/t_P$
15 Hz ... 1 kHz	2 ... 98 %
... 10 kHz	5 ... 95 %
... 50 kHz	10 ... 90 %

V  $\Omega$  Temp  $\rightarrow$   $\rightarrow$   $\rightarrow$  COM

max. 5 V

## 5.2 Resistance, Conductivity and Low-Resistance Measurement

- Disconnect supply power from the electrical circuit of the device to be measured, and discharge all high-voltage capacitors.
- Make sure that the device under test is voltage-free. Interference voltages distort measurement results! Refer to section 5.1.1 regarding testing for the absence of voltage with the help of the direct voltage measurement.
- Set the rotary switch to “ $\Omega$ ” or “nS”.
- Connect the device under test as shown.

### Note

Use short or shielded measurement cables in the case of high-impedance resistance.

$\Omega$  and R<sub>PE</sub>: “OL” appears at the display in the case of an open connection.

nS: “OL” (under range) appears at the display in the case of an open connection.

### Improving Accuracy for Resistance and Low-Resistance Measurement by means of Zero Balancing

Cable resistance and contact resistance can be eliminated in all measuring ranges by means of zero balancing (see section 4.2) (applies to  $\Omega$  and R<sub>PE</sub> functions only).

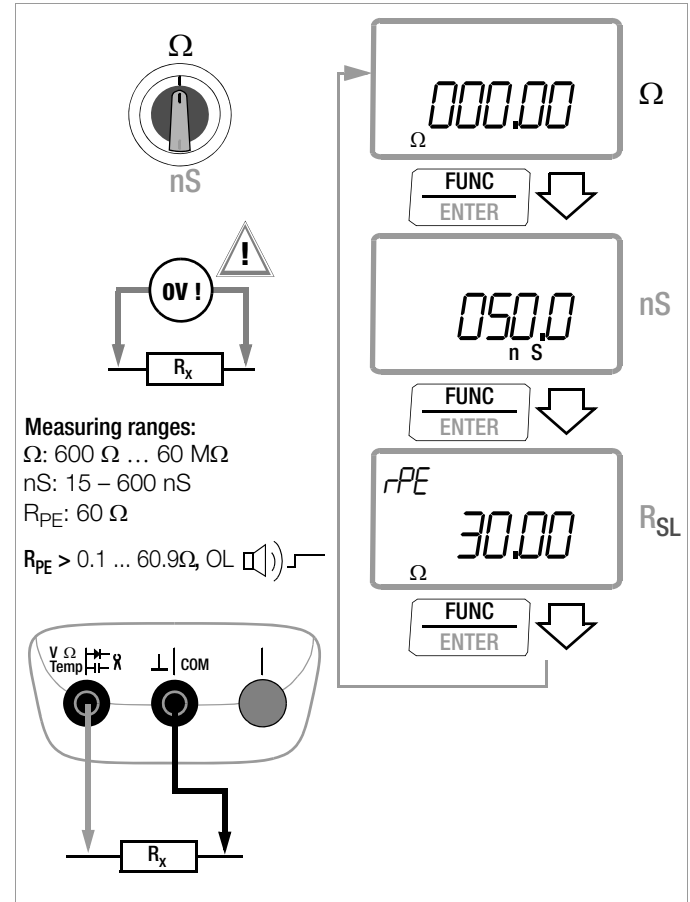

### 5.2.1 Conductivity Measurement

Conductivity measurement works within a range of 15 to 600 nS. “ur” (under range) appears at the display for values below this range, and “OL” appears for value which exceed the range.

### 5.2.2 Low-Resistance Measurement with Constant Current (RPE)

RPE measurement is started by pressing the **FUNC** key twice with the selector switch in the  $\Omega$  or nS position:

This is a low-resistance measurement within a range of 0.01 to 60  $\Omega$  with a constant current of approximately 3 mA.

Open circuit voltage is roughly 9 V.

Zero balancing must be executed before performing this measurement.

#### Zero Balancing

- ⇨ Plug the measurement cables into the instrument and connect the free ends to each other.
- ⇨ Briefly press the **ZERO | ESC** key.  
The instrument acknowledges zero balancing with an acoustic signal, and the “ZERO  $\Delta$ REL” symbol appears at the LCD. The value measured at the moment the key is pressed serves as a reference value.
- ⇨ Zero balancing can be cleared by once again pressing the **ZERO | ESC** key.

### Limit Value for Low-Resistance Measurement

In the event of a measured value which exceeds the selected limit value, the system multimeter generates a continuous acoustic signal. The limit value can be adjusted in the “**SEt**” menu in 0.1  $\Omega$  steps (see also section 6.4):

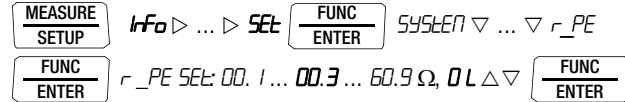

(0.3  $\Omega$  = default setting)

### 5.3 Continuity Test (|)) with Constant Current of 1 mA

- Disconnect supply power from the electrical circuit of the device to be measured, and discharge all high-voltage capacitors.
- Make sure that the device under test is voltage-free. Interference voltages distort measurement results!
- Set the rotary switch to (|)).
- Connect the conductor path under test as shown.

“OL” appears at the display in the case of an open connection. Open circuit voltage is approximately 3 V.

#### Limit Value for Voltage Resistance

Depending upon the selected limit value, the multimeter generates a continuous acoustic signal in the case of continuity or short-circuiting, i.e. at a value of less than the selected limit value. The limit value can be adjusted in the “SEL” menu (see also section 6.4):

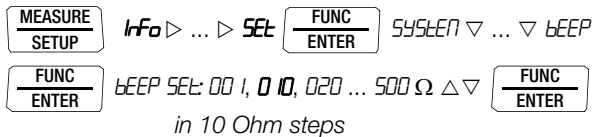

(10 = default setting)

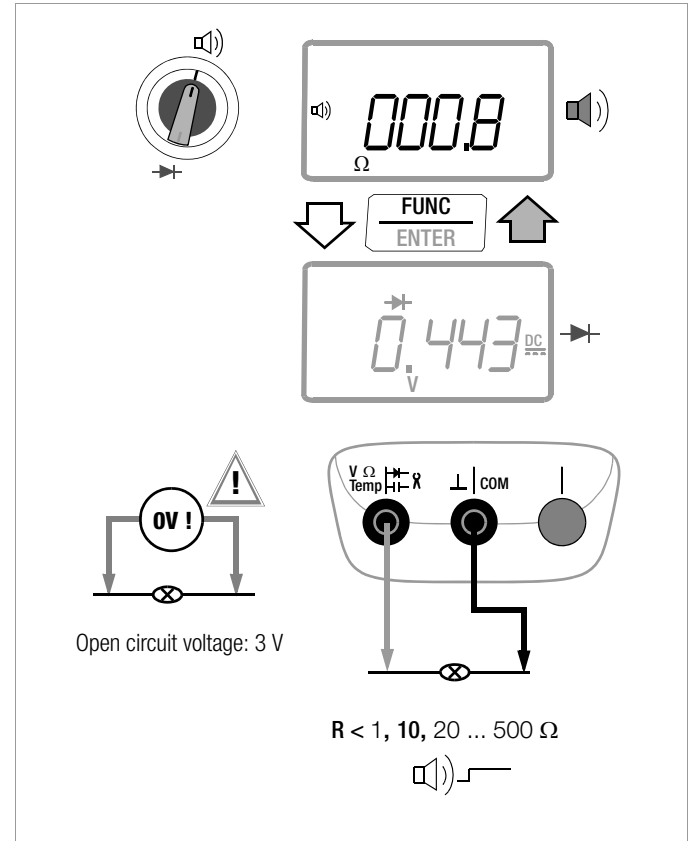

#### 5.4 Diode Testing $\rightarrow$ with Constant Current of 1 mA

- ❖ Disconnect supply power from the electrical circuit of the device to be measured, and discharge all high-voltage capacitors.
- ❖ Make sure that the device under test is voltage-free. Interference voltages distort measurement results! Refer to section 5.1.1 regarding testing for the absence of voltage with the help of the direct voltage measurement.
- ❖ Set the rotary switch to  $\rightarrow$ .
- ❖ Acknowledge by pressing the **FUNC | ENTER** key.
- ❖ Connect the device under test as shown.

#### Forward Direction and Short-Circuit

The instrument displays forward voltage in volts (display: 4 places). As long as voltage drop does not exceed the maximum display value of 6.0 V, several series connected components or reference diodes can be tested with a small reference voltage and Z-diodes.

#### Reverse Direction and Interruption

The measuring instrument indicates overload: "OL".

#### Note

Resistors and semiconductor paths connected in parallel to the diode distort measurement results!

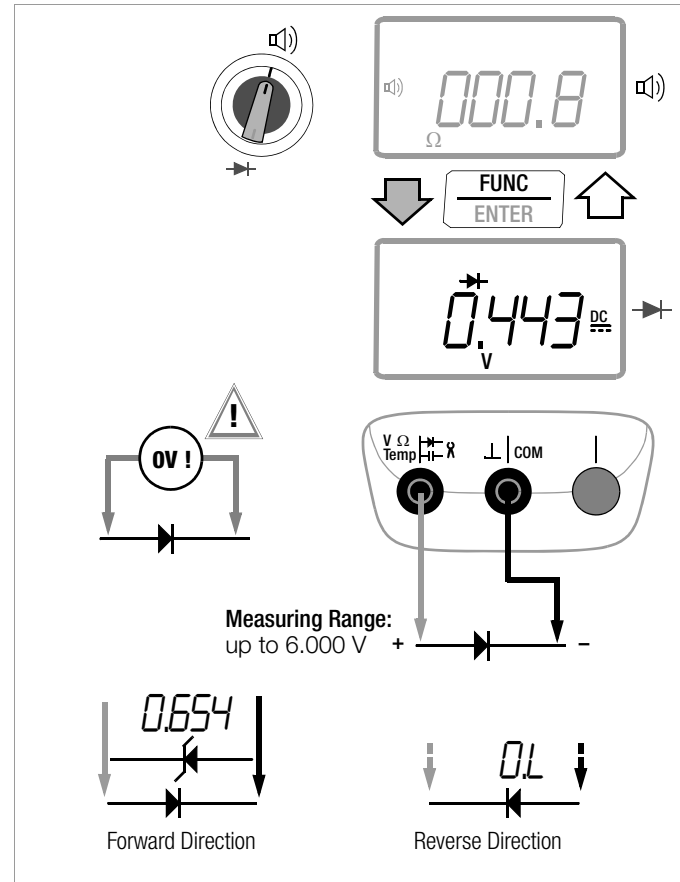



## 5.5 Temperature Measurement

Temperature measurement is performed with a type K thermocouple or a type Pt100 or Pt1000 resistance sensor (accessory, not included) which is connected to the voltage input.

Refer to section 6.4 regarding selection of the temperature unit of measure.

### 5.5.1 Measurement with Thermocouples, Temp TC

- ⇨ Set the rotary switch to “Temp<sub>TC</sub>”.

#### Note

The last selected temperature measurement or the last selected temperature sensor, i.e. type K or Pt100/Pt1000, remains in memory and is accordingly displayed. Press the **FUNC | ENTER** key in order to change to the other measuring function.

- ⇨ Either the internal reference junction or an external reference temperature can be specified as the reference temperature (see section 6.4.3). Type (“I.” for internal or “E.” for external) and temperature of the selected reference junction appear at the right-hand auxiliary display during measurement.

#### Note

The internal reference temperature (temperature of the internal reference junction) is measured by a temperature sensor inside of the instrument. This may deviate somewhat from room temperature as a result of internal heat-up, or moving from warmer to colder surroundings or vice versa.

- ⇨ Connect the sensor to the two accessible jacks. The instrument displays the measured temperature using the selected unit of measure.

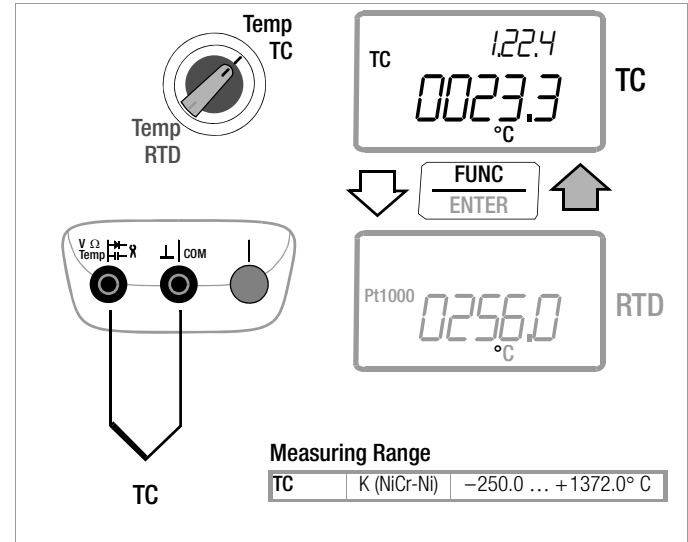

#### Note

After previously performing a 10 A current measurement, the measuring instrument should be allowed to cool down for 30 minutes before performing measurements with thermocouples, in order to assure that the specified accuracy levels are achieved.

### 5.5.2 Measurement with Resistance Sensors

- Set the rotary switch to “Temp<sub>TC</sub>” or “Temp<sub>RTD</sub>”.

The last selected temperature measurement or last selected temperature sensor, i.e. type K or Pt100/Pt1000, remains in memory and is displayed. Press the **FUNC | ENTER** key in order to change to the other measuring function. The sensor type, i.e. Pt100 or Pt1000, is detected automatically and displayed. There are two different ways to compensate for cable resistance:

#### Automatic Compensation

- Press the **ZERO | ESC** key. The “short leads” display appears. If you prefer to enter cable resistance directly, you can skip the following entry prompt.
- Short circuit the measuring instrument’s connector cables. “00.00” appears at the display. After pressing the **FUNC | ENTER** key, automatic compensation of cable resistance is activated for all subsequent measurements. The short-circuit can now be eliminated, and the device is ready for use.

#### Entering Cable Resistance

- Press the **ZERO | ESC** key once again in the automatic compensation menu.
- Enter the known resistance value of the connector cables with the scroll keys: Select the digit to be changed with the left/right cursor and change the respectively selected digit with the  $\nabla$ / $\Delta$  keys. The default value is 0.43  $\Omega$  (Z3409). Values can be selected within a range of 0 to 50  $\Omega$ .
- Upon pressing the **FUNC | ENTER** key, the selected value is activated and the display is returned to the measuring function. Cable resistance remains in memory even after the instrument has been switched off.

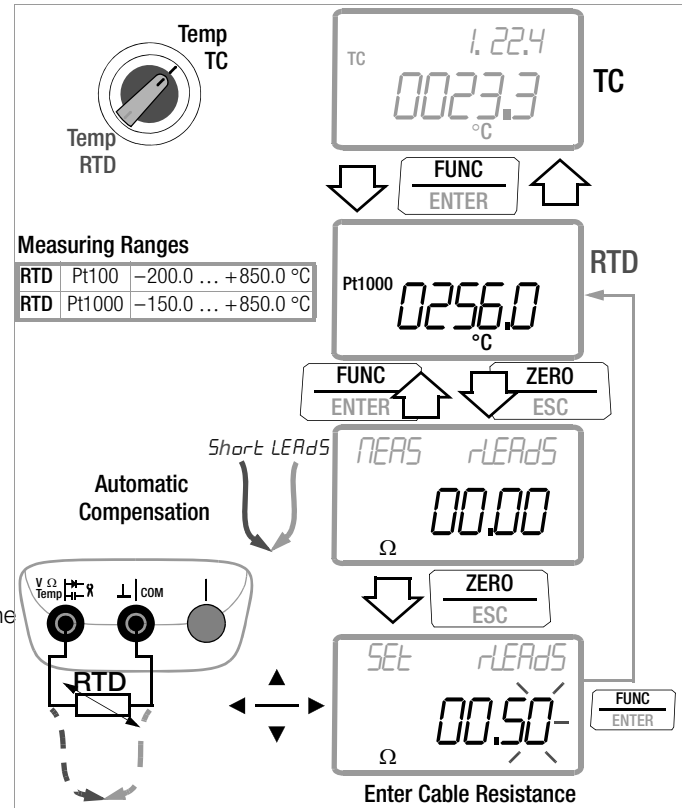

### 5.6 Measuring Capacitance $\rightarrow$ and Cable Length in km

- Disconnect supply power from the electrical circuit of the device to be measured, and discharge all high-voltage capacitors.
- Make sure that the device under test is voltage-free. Capacitors must always be discharged before measurement is performed. Interference voltages distort measurement results! Refer to section 5.1.1 regarding testing for the absence of voltage with the help of the direct voltage measurement.
- Set the rotary switch to “ $\rightarrow$ ” or m.
- Connect the (discharged!) device under test to the sockets with the measurement cables as shown.



**Note**

The “-” pole of polarized capacitors must be connected to the “^” jack. Resistors and semiconductor paths connected in parallel to the capacitor distort measurement results!



**Note**

Use of the power pack may result in significant deviations during capacitance and cable length measurements!



**Note**

This function is above all intended for the measurement of components. For telecommunication systems, it's advisable to use the special capacitance measurement for measurements in symmetrical copper cable networks **with the METRAHIT | T-COM PLUS** cable multimeter.

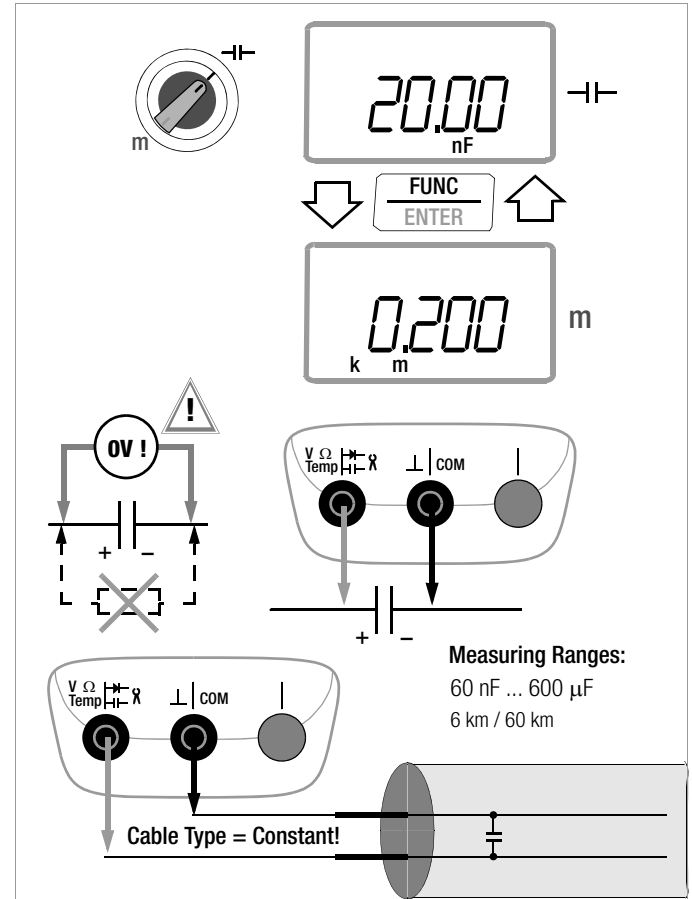

### 5.6.1 Cable Length Measurement in m

In the cable length measuring mode, the instrument calculates length as a function of the capacitance value entered by the user:

$$\text{Length (km)} = \frac{\text{measured capacitance (nF)}}{\text{capacitance value (nF / km)}}$$

Preparation and execution of this measurement is the same as for capacitance measurement.

- Press the multifunction key (**FUNC | ENTER**) until “k” and “m” (for kilometers) appear at the display.

#### Note



Use of the power pack may result in significant deviations during capacitance and cable length measurements!

#### Note

When measuring cable length, make sure that the cable parameters (e.g. cross-section) are identical. Varying cable parameters, for example interconnected cables of **varying type or cross-section**, distort measurement results.

### CAP – Scaling Factor for Cable Length Measurement (capacitive linear electric constant)

With regard to adjusting the “CAP” scaling factor (capacitive linear electric constant), see also section 6.4.

Info ▶ ... ▶

FUNC

SYSTEM ▼ ... ▼
CAP

CAP SET: 0 10 nF/km ... 100 nF/km ... 500 nF/km ▲ ▼



(100 nF = default setting)

### 5.7 Measurement of Active, Apparent and Reactive power – W, VA, VAR Measurement of Active, Apparent and Reactive Energy – Wh, VAh, VARh

The METRAHIT ENERGY is a compact power meter for direct and alternating current in single-phase systems. The current path can be measured directly (up to 10 A, max. 5 min., up to 16 A briefly for max. 30 s), or with the help of current transformers or current clamp transformers.

#### Power Measuring Ranges (without current clamp; clamp factor can be calculated)

I / U range	0.6 V	6 V	60 V	600 V
600 μA	0.36 mW	3.6 mW	36 mW	0.36 W
6 mA	3.6 mW	36 mW	0.36 W	3.6 W
60 mA	36 mW	0.36 W	3.6 W	36 W
0.6 A	—	3.6 W	36 W	0.36 kW
6 A	—	—	0.36 kW	3.6 kW
10 A (16 A)	—	—	0.6 kW (0.96 kW)	6 kW (9.6 kW)

Bandwidth up to 1 kHz; signal components of higher frequency are clipped by input filters.

The instrument automatically selects the measuring range which allows for highest possible resolution of the applied quantities. It's also possible to lock in the automatically selected measuring range with the **MAN / AUTO** key. If the measuring range has been locked in, this selection is retained when the instrument is switched to the energy measuring mode.

*A detailed description of the measuring range selection and the lock-in function is provided in section 4.1.2 „Power and Energy Measurements“ on page 17.*

#### Note

If the measuring instrument activates a measuring range which is too high during automatic measuring range selection, this may be due to peak value monitoring (see section 4.1.3 on page 17). Check the crest factor of the respective signal in  $V_{AC+DC}$  or  $A_{AC+DC}$ .

#### Significance of the Power Factor

±1: no phase shifting

–(0 ... 0.99): capacitive; +(0 ... 0.99): inductive

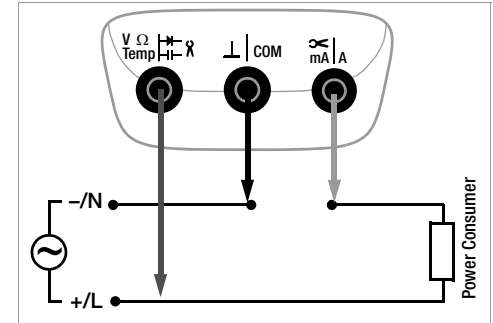

- First disconnect supply power from the measuring circuit or the power consumer, and discharge any capacitors.
- Set the rotary switch to W. The instrument displays RMS values for voltage and current, as well as active power.
- You can switch the display back and forth amongst active, reactive and apparent power with the < and > keys (including power factor).
- The extreme values can be displayed by pressing the **DATA/MIN/ MAX** key.
- Press the **FUNC | ENTER** key in order to measure active, apparent and reactive power.
- Connect the current and voltage path as shown above.

Use current clamp transformers only. Power measurement is not possible with current clamp sensors equipped with voltage output.

**Note:**

See also section 4.5.2, "Power and Energy Measurement in the Memory Mode".

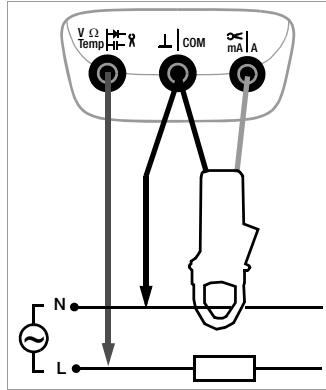

**Min-Max Function in Power Measurement**

Instantaneous power is displayed with the switch in the W setting. The Min-Max function is activated with the **DATA/MIN/MAX** key. The minimum and maximum values for active, reactive an apparent power are display as of the beginning of the power measurement, along with time of occurrence (date and time). Previous Min-Max values can be cleared without exiting the function by pressing the ZERO key.

This function differs from the general Min-Max function insofar as measurement is performed continuously in the background, even if the Min-Max display is not shown, and while the instrument is in the energy measuring mode.

**Measurement of Active, Apparent and Reactive Power, and Power Factor – W, VA, VAR, PF**

**W**

000.0 mV
0000.0 mA

000.00

$\mu$  W
DC  
AC  
TRMS

MAN / AUTO

DATA/MIN/MAX

**VA**

PF:0.00
000.00

000.00

$\mu$  VA
DC  
AC  
TRMS

MAN / AUTO

DATA/MIN/MAX

**VAR**

000.0 mV
0000.0 mA

000.00

$\mu$  VAR
DC  
AC  
TRMS

MAN / AUTO

DATA/MIN/MAX

**W measuring ranges:**  
 3.6 mW / 36 mW / 360 mW  
 3.6 W / 36 W / 360 W  
 3.6 kW / 6 kW / 36 kW\* /  
 360 kW\* / 3.6 MW\*

\* With current clamp trans. only

**Bandwidth:**  
 ... 1 kHz

**PF measuring range:**  
 -(0 ... 0.99): capacitive  
 +(0 ... 0.99): inductive  
 $\pm$ 1: no phase shifting

**Overload capacity at 600 V:**  
 10 A (max. 5 min.)   
 16 A (max. 30 s)

**Warnings regarding dangerous voltage:**  
 > 30 V AC or > 35 V DC:

Measurement of Momentary, Minimum and Maximum Values for Active, Reactive and Apparent Power

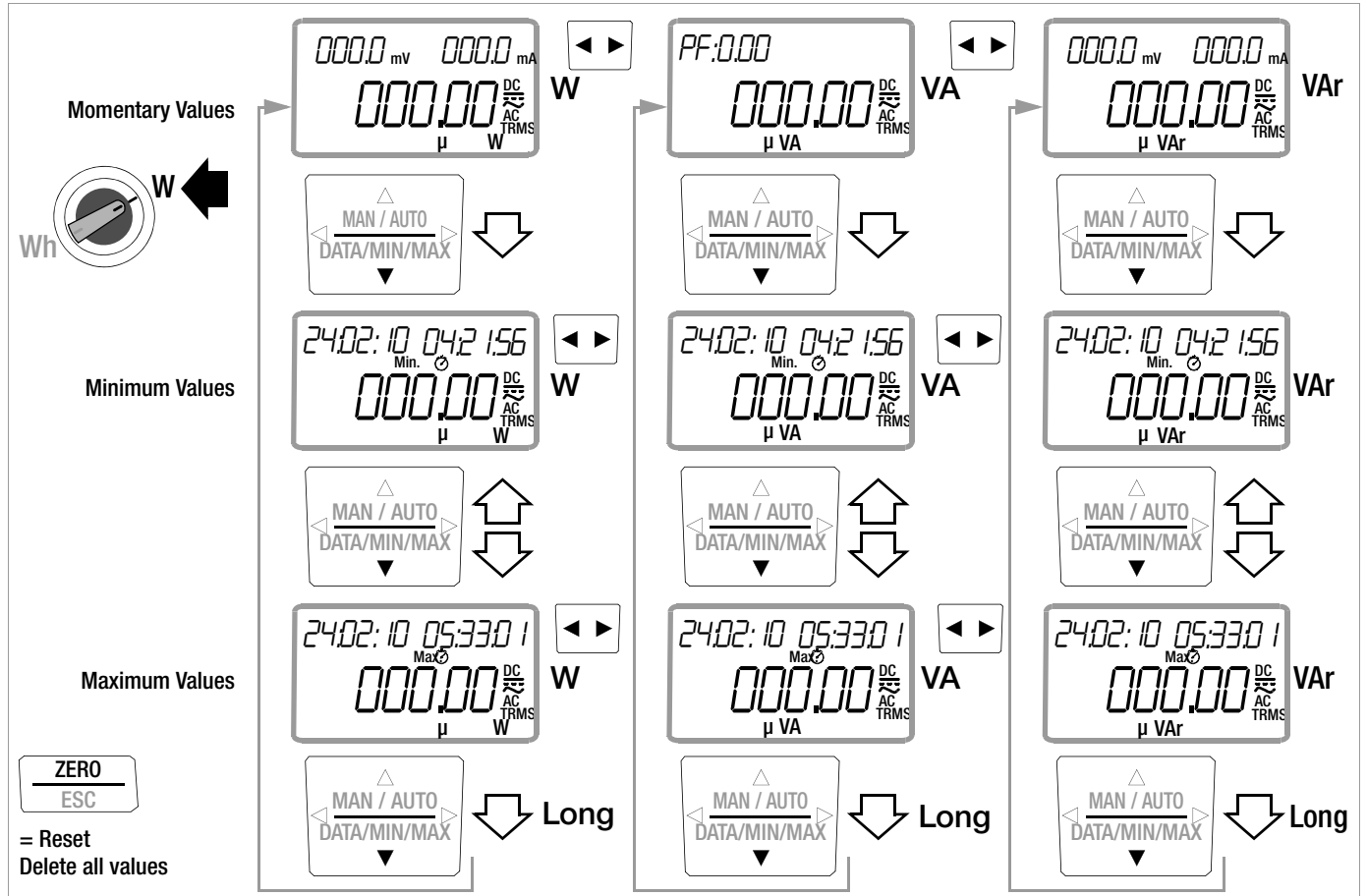

### Measurement of Active, Apparent and Reactive Energy – Wh, VAh, VARh

The instrument can be switched back and forth between energy and power measurement by pressing the **FUNC | ENTER** key. Energy measurement begins as soon as power or energy measurement has been started.

Measured values resulting from power or energy measurement can be reset by pressing and holding the **ZERO | ESC** key for longer than 1 second. This applies to the MEAN and MAX displays as well (mean power values and maximum mean power values).

Energy measurement is an integration of measured power over a period of time: If integration duration is long enough (negligible settling times), accuracy of the energy measurement corresponds to the measuring accuracy of the power measurement on which it is based.

---

#### Note

Due to the fact that invalid values occur briefly during measuring range switching for current or voltage during power measurement, it's advisable to lock into the largest measuring range during energy measurement in the event of frequent range changes.

---

### Mean Power Values

Mean power consumption can be displayed by pressing the **DATA/MIN/MAX** key, which can be reset after an adjustable observation period that can be configured in the menu under **SEt > dEMAnd tiME**. The observation period is selected synchronous to clock time, so that the mean value generating period for the first value is usually shorter than the selected observation period.

Example: demand time = 15 min., start time for first period: 16:36 => the first value is generated at 16:45, the second at 17:00 etc.

If the auto-send function has been activated and energy measurement has been selected, mean power consumption values are transmitted after this point in time, if the **dEMAnd** option has been selected in the menu under **Set > Energy > Store**.

### Maximum Mean Value for Power Consumption

The maximum mean power consumption value during the observation period can be read out with date and ending time of the observation period by repeatedly pressing the **DATA/MIN/MAX** key (**dEMAnd tiME** parameter: see page 68).



Measurement of Energy Values, and Mean Power Values for Active, Reactive and Apparent Power

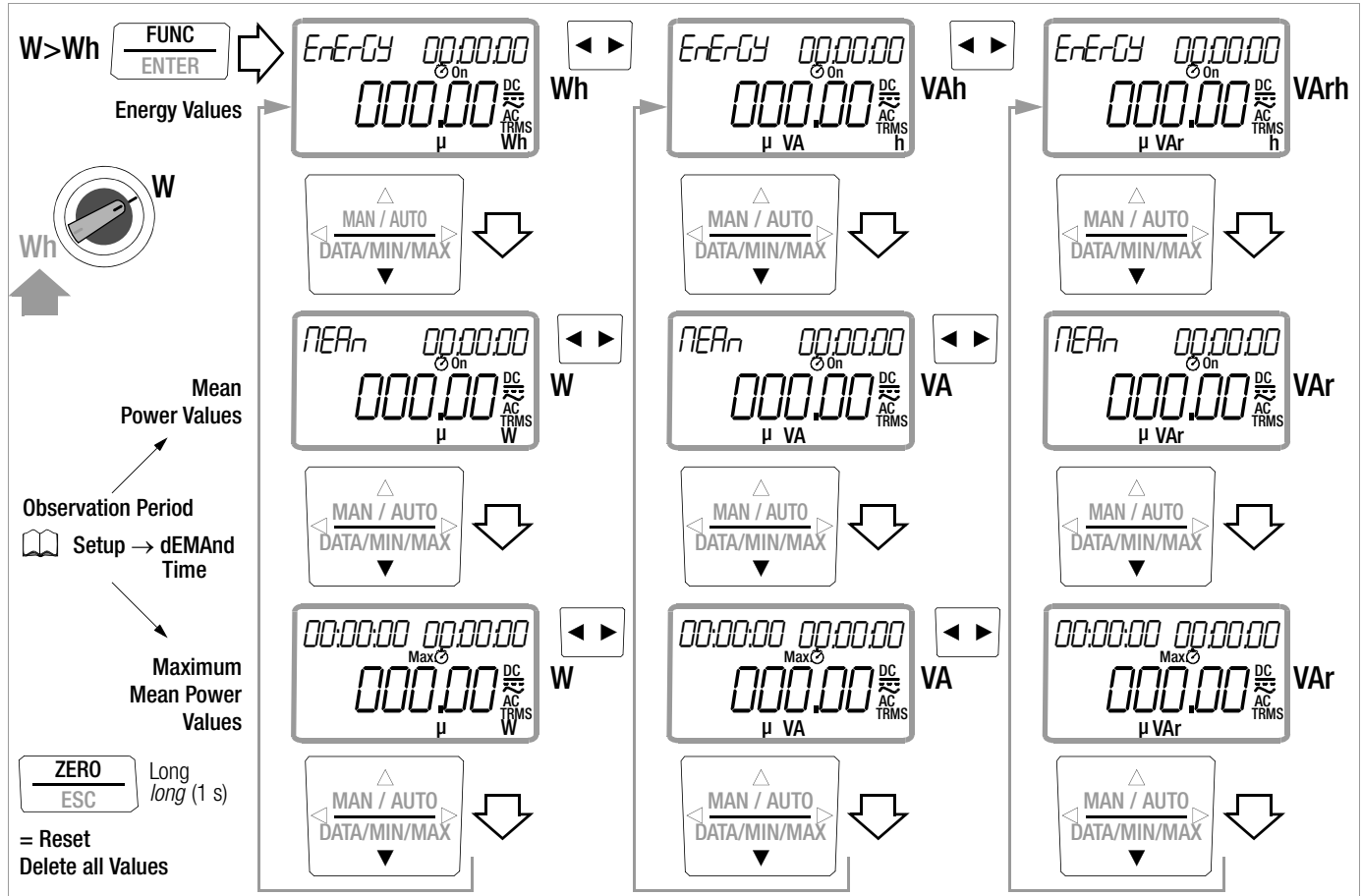

## 5.8 Current measurement

### Notes Regarding Current Measurement

- The multimeter may only be operated with installed batteries or rechargeable batteries. Dangerous currents are otherwise not indicated, and the instrument may be damaged.
- Set up the measuring circuit in a mechanically secure fashion, and secure it against inadvertent breaks. Select conductor cross-sections and lay out connections such that they do not overheat.
- An intermittent acoustic signal warns of current greater than 10 A. An continuous acoustic signal warns of current greater than 16 A.
- **When measuring high current values, limit them to maximum 16 A for 30 seconds and allow the multimeter to cool down for 10 minutes between measurements.**
- **For purposes of orientation, internal temperature in close proximity to the jacks is displayed at the right-hand auxiliary display in the 6 A and 10 A or 16 A ranges.**
- The input for the current measuring range is equipped with a fuse link. Use specified fuses only! The fuse must have a breaking capacity of at least 30 kA.
- If the fuse for the active current measuring range blows, “FUSE” appears at the digital display, and an acoustic signal is generated at the same time.
- If a fuse should blow, eliminate the cause of overload before placing the multimeter back into service!
- Fuse replacement is described in section 9.3.
- Be absolutely certain that the measuring ranges are not overloaded beyond their allowable capacities. Limit values are included in section 8, “Technical Data”, in the table entitled “Measuring Functions and Measuring Ranges” in the “Overload Capacity” column.

### Scope of Functions, Current Measurement, Direct Connection

Function	Switch Position	Measuring Range
Transformation ratio $\square$	SET menu, CliP=OFF	
A AC+DC TRMS $\square$	$A_{\square}$	600 $\mu$ A, 6/60/600 mA, 6 A / 10 (16) A
A DC $\square$	$A_{\square}/\sim$	600 $\mu$ A, 6/60/600 mA, 6 A / 10 (16) A
A AC $\sim$	$A_{\square}/\sim$	600 $\mu$ A, 6/60/600 mA, 6 A / 10 (16) A
Hz (A AC)	$A_{\square}/\sim$	... 60 kHz
thd (A AC)	$A_{\square}/\sim$	

### Scope of Functions, Current Measurement with Current Clamp Sensor

Function	Switch Position
Transformation ratio $\square$	SET menu, CliP $\neq$ OFF
A AC+DC $\square$	$V_{\square}$
A DC $\square$	$V_{\square}$
A AC $\sim$	$V_{\sim}$
Hz (A AC)	$V_{\sim}$
thd (A AC) $\square$	$\square$

### Scope of Functions, Current Measurement with Current Clamp Transformer

Function	Switch Position
Transformation ratio $\square$	SET menu, CliP $\neq$ OFF
A AC $\square$	$A_{\square}/\sim$
Hz (A AC)	$A_{\square}/\sim$
thd (A AC) $\square$	$A_{\square}/\sim$
A AC+DC $\square$	$A_{\square}$
A DC $\square$	$A_{\square}/\sim$

### 5.8.1 Direct Current Measurement

#### Measurement of Pulsating, Direct and Alternating Current, and Frequency A (DC+AC), A DC and A AC/Hz Direct, and Total Harmonic Distortion

- ⇨ First disconnect supply power from the measuring circuit or the power consumer (1), and discharge any capacitors. See circuit diagram on next page.
- ⇨ In accordance with the current to be measured, set the rotary switch to A $\overline{\approx}$  or A $\overline{\sim}$ .



#### Note

Set the  $CL, P$  parameter to **OFF** in the current clamp setup menu. Otherwise all displayed measured values are corrected by the amount resulting from the selected transformation ratio for an interconnected current clamp transformer. The clamp symbol is also displayed. Refer to section 5.8.2, "Current Measurement with Current Clamp Sensor"; regarding adjustment.

- ⇨ Select the type of current appropriate for the measured quantity by briefly pressing the **FUNC | ENTER** multifunction key. Each time the key is pressed, the instrument is switched back and forth between A (DC + AC)<sub>TRMS</sub>, A DC, A AC<sub>TRMS</sub>/Hz and % thd, which is indicated by means of an acoustic signal. The current type is indicated at the LCD by means of the (DC+AC)<sub>TRMS</sub>, DC or AC<sub>TRMS</sub> symbol.  
thd measurement: Total harmonic distortion appears at the main display as a percentage relative to the fundamental harmonic, and the total RMS value of distortion appears at the right-hand auxiliary display in A.
- ⇨ Safely connect the measuring instrument (without contact resistance) in series to the power consumer (2) as shown.

- ⇨ Switch supply power to the measuring circuit back on (3).
- ⇨ Read the display. Make a note of the measured value if the instrument is not being operated in the memory mode or the transmission mode.
- ⇨ Disconnect supply power from the measuring circuit or the power consumer (1) once again, and discharge any capacitors.
- ⇨ Remove the test probes from the measuring point and return the measuring circuit to its normal condition.

#### Crest Factor Display

Crest factor is displayed for current in the A (AC+DC) function simultaneously along with the measured current value. The peak current value is measured simultaneously in a separate measuring circuit to this end, and crest factor is displayed within a range of 1.0 to 11.0.

This value indicates the quality of the applied signal. The only prerequisite is a periodic signal with a valid frequency (see table).

Measuring range:  $1.0 \leq CF \leq 11.0$ ; resolution: 0.1

Typical (not specified) maximum deviation for signals greater than 5% of the measuring range:

Frequency	CF ≤ 3.0	3.0 < CF ≤ 5.0	5.0 < CF ≤ 10.0
10 to 70 Hz	±02	±0.2	±0.5
70 to 440 Hz	±02	±0.5	Not valid
440 Hz to 1 kHz	±05	Not valid	Not valid
> 1 kHz:	Not valid	Not valid	Not valid

### Harmonic Analysis – Total Harmonic Distortion THD

With 32 sampled values per mains period (16.7; 50; 60 or 400 Hz can be selected in the menu), harmonic analysis is executed approximately once per second. FFT (fast Fourier transformation) makes oscillations up to the 15<sup>th</sup> harmonic available to this end. These are used to calculate the RMS values of the fundamental harmonic (HD 1) and the individual higher harmonics (HD 2 ... 15), as well as total harmonic distortion (THD). RMS values and distortion components are displayed in each case (RMS values relative to the RMS value of the fundamental harmonic).

Due to the fact that the TRMS system multimeter is not equipped with a special anti-aliasing filter, existing distortion above the 16<sup>th</sup> harmonic may influence measurement results for the higher harmonics.

### Parameters for Harmonic Analysis

- ⇨ Before measurement, please select the fundamental mains frequency from the HARM menu with the help of the HARM.F parameter, namely 16.7, 50, 60 or 400 Hz (50 Hz = default setting) (see section 6.4, "Entering Parameters – SETUP Menu").

CL, P = OFF



**Current measurement may only be performed with installed batteries!**



**A measuring range:**  
 600  $\mu$ A / 6 mA  
 60 mA / 600 mA  
 6 A\* / 10 A\* (16 A max. 30 s)

**Hz measuring range:**  
 1 ... 60 kHz

Total RMS value of distortion in A

thd: total distortion as percentage relative to fundamental harmonic

\* Additional temperature display (internal temperature at jacks) in the 6 A and 10 A ranges

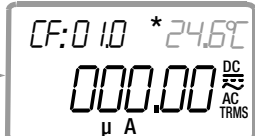

Crest factor CF: 1 ... 11%

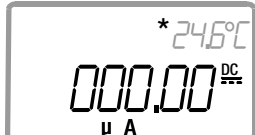
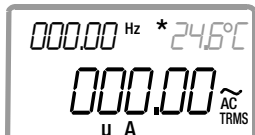
Frequency

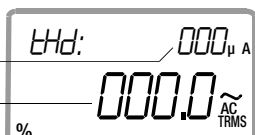

thd

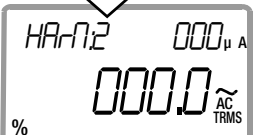

Harmonics: 2 ... 15  
 RMS value, 2<sup>nd</sup> harmonic  
 Distortion through 2<sup>nd</sup> harmonic

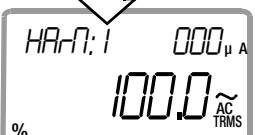

Fundam. harmonic: 1<sup>st</sup> harmonic  
 HAR:1 RMS value of fund. harmonic in A  
 100% for fund. harmonic

Parameters for harmonic analysis:  
**Line frequency:** HAR:F: 16.7/50/60/400 Hz  
**Measuring range:** I:AR:GE: 600 $\mu$ A/6/60/1600mA/6/10 A/A<sub>PL</sub>t<sub>0</sub>

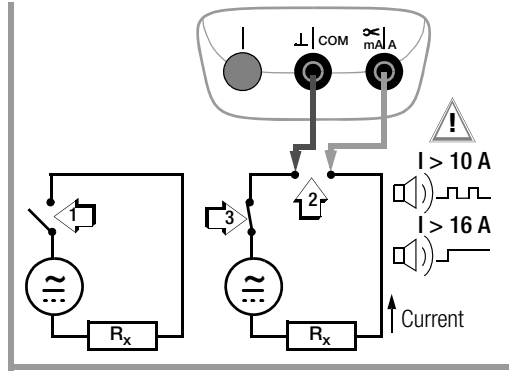

COM mA/A

I > 10 A  
I > 16 A

Current

## 5.8.2 Current Measurement with Current Clamp Sensor

### Voltage/Current Transformer Output

When a current clamp sensor is connected to the system multimeter (V  $\rightarrow$  input), all current displays appear with the correct value in accordance with the selected transformation ratio. The only prerequisite is that the current sensor is equipped with at least one of the below listed transformation ratios, and that the ratio has been previously selected in the following menu (CL, P  $\neq$  OFF) (see also section 6.4).

### Current Clamp Setup Menu

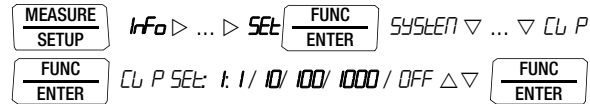

Trans. Ratio CL, P	DMM Measuring Range			Clamp Types
	600 mV	6 V	60 V	
<b>1:1</b> 1 mV / 1 mA	600.00 mA	6.0000 A	60.000 A	WZ12C
<b>1:10</b> 1 mV / 10 mA	6.0000 A	60.000 A	600.00 A	WZ12B, Z201A/B, METRAFLEX
<b>1:100</b> 1 mV / 100 mA	60.000 A	600.00 A	6000.0 A	Z202A/B, METRAFLEX
<b>1:1000</b> 1 mV / 1 A	600.00 A	6000.0 A	60000 A	Z202A/B, Z203A/B, WZ12C, METRAFLEX

The maximum allowable operating voltage is equal to the nominal voltage of the current transformer. When reading the measured value, additional error resulting from the current clamp sensor must also be taken into consideration (default setting: CL, P = OFF).

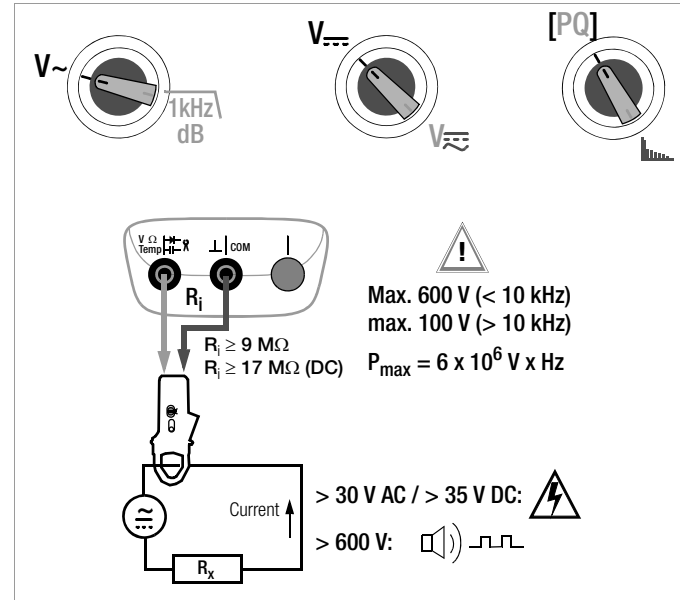

### Harmonic Analysis with Current Clamp Sensor

Parameters for harmonic analysis:

See section 6.4.6 on page 71.

### Alternating Current Measurement with Current Clamp Sensor – A AC and Hz

CL, P ≠ OFF!

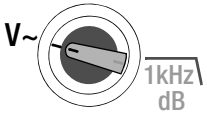

1kHz/dB

050.00 Hz

100.50 A

Hz

AC TRMS

A ~

FUNC  
ENTER

050.00 Hz

Hz

AC TRMS

A ~

### Direct and Pulsating Current Measurement with Current Clamp Sensor – A DC and A (DC+AC)

CL, P ≠ OFF!

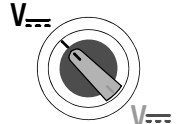

V=

000.00 A

A =

FUNC  
ENTER

CF: 0.10

000.00 A

CF

DC

AC TRMS

A =

### Harmonic Analysis with Current Clamp Sensor – thd and A AC

CL, P ≠ OFF!

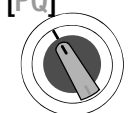

[PQ]

thd: 000.0 A

000.0 A

%

MAN / AUTO  
DATA/MIN/MAX

HA-r:1 000 A

100.0 A

%

AC TRMS

MAN / AUTO  
DATA/MIN/MAX

HA-r:2 000 A

000.0 A

%

AC TRMS

ZERO  
ESC

Harmonics: 3 ... 15

Parameters: SET > HA-r > HA-r.F: 16.7 / 50 / 60 / 400 Hz

### 5.8.3 Current Measurement with Current Clamp Transformer

Alternating Current Measurement and Total Harmonic Distortion, Direct and Pulsating Current – A AC and thd, A DC, A AC+DC

#### Current/Current Transformer Output

When a current clamp transformer is connected to the multimeter (⌘ mA/A input) all current displays appear with the correct value in accordance with the selected transformation ratio. The only prerequisite is that the current transformer is equipped with at least one of the below listed transformation ratios, and that the ratio has been previously selected in the following menu (**CL, P ≠ OFF**) (see also section 6.4).

Trans. Ratio <b>CL, P</b>	DMM Measuring Range			Clamp Types
	60 mA AC	600 mA AC	6 A AC	
<b>1:1</b> 1 mA / 1 mA	60.000 mA	600.00 mA	6.0000 A	WZ12A, WZ12D, WZ11A, Z3511, Z3512, Z3514
<b>1:10</b> 1 mA / 10 mA	600.00 mA	6.0000 A	60.000 A	
<b>1:100</b> 1 mA / 100 mA	6.0000 A	60.000 A	600.00 A	
<b>1:1000</b> 1 mA / 1 A	60.000 A	600.00 A	6000.0 A	

#### Note

The order of the measuring functions for switch position A  $\Rightarrow$  is changed when a clip factor is selected:

The two AC measuring functions, A AC and thd (A AC), are moved to the beginning, because DC current cannot be measured with common current clamp transformers.

(default setting: **CL, P = OFF**)

#### Current Clamp Setup Menu

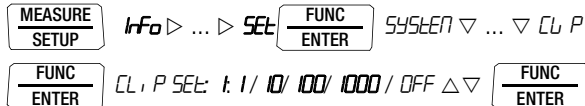



CLIP = 1:1/10/100/1000

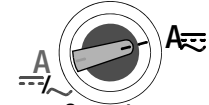

Current measurement may only be performed with installed batteries!



A measuring range:  
60 mA / 600 mA / 6 A  
to 0.7 A continuous  
10 A 5 min

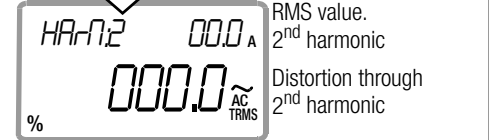
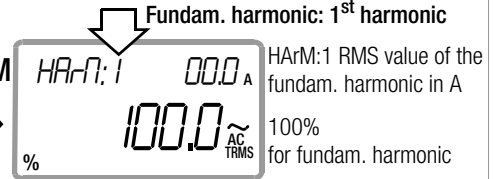
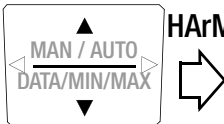
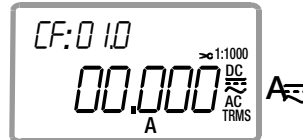
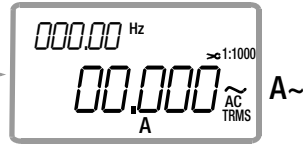
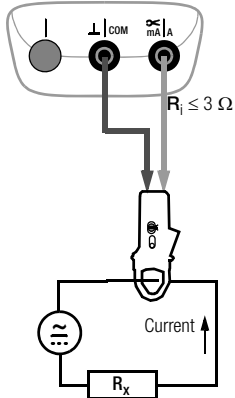

Parameters for harmonic analysis:

Line frequency: SET>HAr-n>HAr-n.F: 16.7/50/60/400 Hz  
 Measuring range: SET>HAr-n>u-rAnGE: 600mV/6/60/600V/Auto  
 Measuring range: SET>HAr-n>I-rAnGE: 600uA/6/60/600mA/6/10 A/Auto

### 6 Device and Measuring Parameters

The instrument's "**SEL**" mode (menu mode) makes it possible to set operating and measuring parameters, query information and activate the interface.

- ⇨ The menu mode is accessed by pressing the **MEASURE | SETUP** key, assuming that the instrument is switched on and set to "Measure" (measuring mode operation).  
"Info" appears at the display.
- ⇨ The main menus, i.e. the "**SEL**", "**SEnd**" and "**StorE**" menus, are accessed, and the display is returned to "Info" by repeatedly activating the  $\triangleleft \triangleright \triangle \nabla$  keys (in any direction).
- ⇨ After selecting the desired main menu, sub-menus are accessed by pressing the **FUNC | ENTER** key.
- ⇨ The desired parameter is selected by repeatedly pressing the  $\triangle \nabla$  keys.
- ⇨ In order to change a parameter, acknowledge it with the **FUNC | ENTER** key, after which "**SEL**" appears in the right-hand auxiliary display.
- ⇨ The  $\triangleleft \triangleright$  keys can be used to position the cursor at the entry position.  
The desired value is selected with the help of the  $\triangle \nabla$  keys.
- ⇨ Changes can only be accepted with the **FUNC | ENTER** key, after which "**SEL**" is cleared from the display.
- ⇨ You can return to the sub-menu without making any changes by pressing the **ZERO | ESC** key, and to the main menu by pressing the **ZERO | ESC** key once again.

After repeatedly pressing the **MEASURE | SETUP** key (without first turning the multimeter off), you can return to the last selected menu or parameter from the measuring mode.

The instrument is returned to measuring mode operation by pressing the **MEASURE | SETUP** key.

#### Example: Setting Time

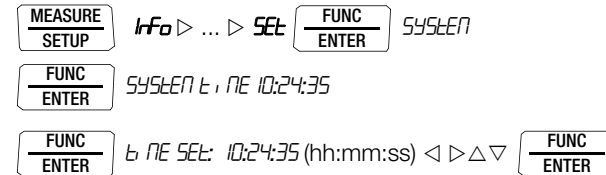

#### Setting hours and minutes:

- $\triangleleft \triangleright$  Advance to desired entry position.
  - $\triangle \nabla$  Change the setting, the entry position blinks.  
Press and hold the key to change the setting rapidly.
- The new time setting is activated after acknowledgment.

6.1 Paths to the Various Parameters

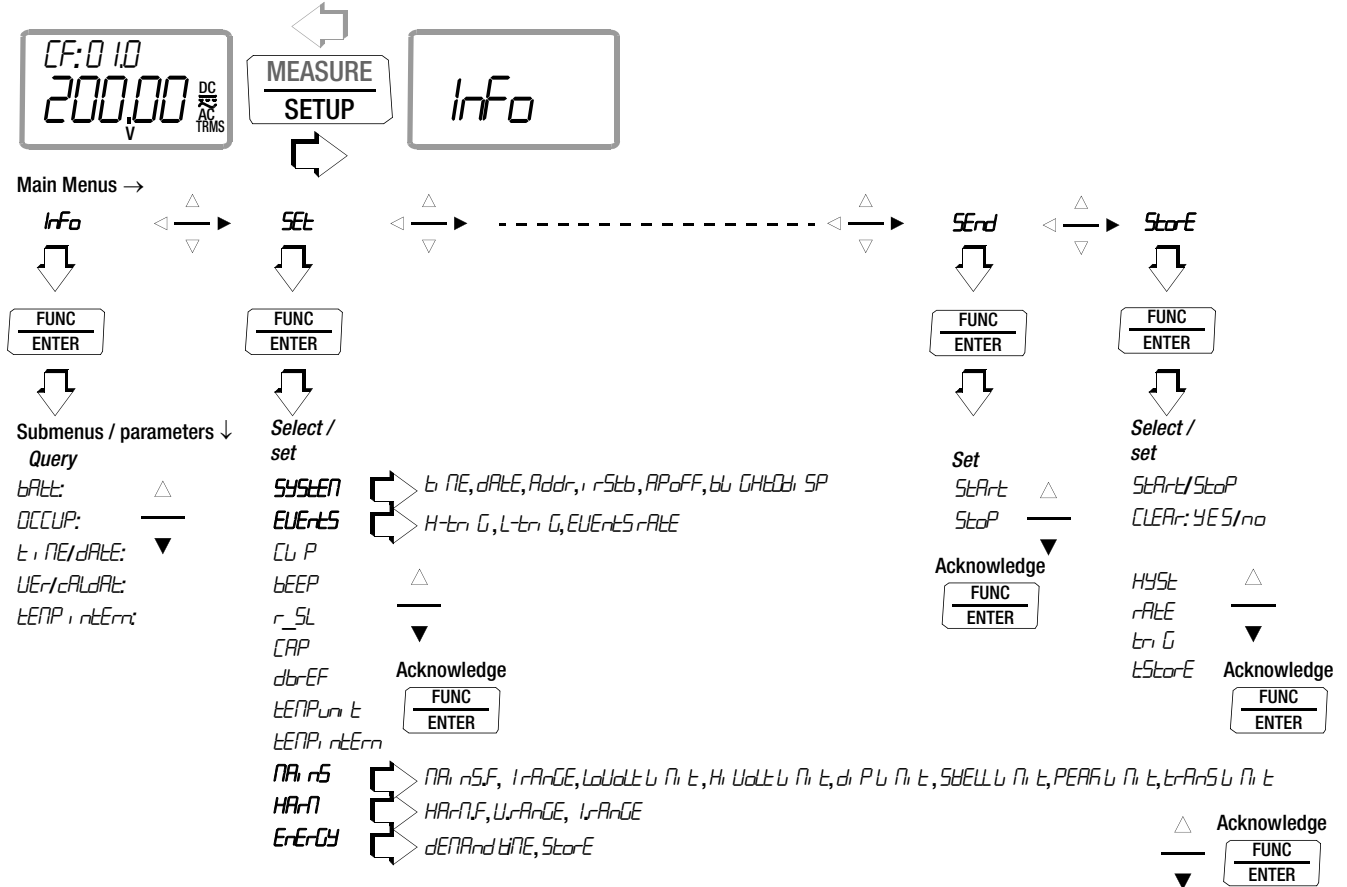

## 6.2 List of all Parameters, Main Menus and Submenus

Menus Parameters	Page: Header	Menu / Submenu	Function / Switch Position
<i>0.dISP</i>	65: 0.dISP – Show/Hide Leading Zeros	SEt/SYSIEM	All
<i>Addr</i>	76: Configuring Interface Parameters	SEt/SYSIEM	Interface operation
<i>APoFF</i>	64: APoFF – Specified Time for Automatic Shutdown and Continuous On	SEt/SYSIEM	All except PQ, W and Wh
<i>bAtt</i>	63: bAtt – Query Battery Voltage	InFo	Parameters query / all
<i>bEEP</i>	66: bEEP – Set Limit Value for Continuity Testing	SEt	
<i>bLiGht</i>	65: bLiGht – Disable Deactivation of Background Illumination	SEt/SYSIEM	All
<i>CAP</i>	66: CAP – Scaling Factor for Cable Length Measurement (capacitive linear electric constant)	SEt	<b>m</b>
<i>CLear</i>	22: Measurement Data Recording – Memory Mode Operation, STORE Menu Function	StorE	Memory mode operation
<i>CLiP</i>	66: CLiP – Set Transformation Ratio (current clamp factor)	SEt	<b>A</b>
<i>dAtE</i>	63: tIME /dAtE – Query Time/Date, 64: dAtE – Enter Date	SEt/SYSIEM	All
<i>dbREF</i>	66: dbREF – Set Reference Value for Alternating Voltage Level Measurement	SEt	<b>dB</b>
<i>dEMAnd tIME</i>	68: dEMAnd tIME – Time Interval for Mean Value Generation (parameter for power measurement in memory mode)	SEt/EnErGY	W/VA/VAr
<i>dIP LiMit</i>	69: SwELL and dIP Limit – Trigger Thresholds for Brief Overvoltages and Undervoltages	SEt/MAInS	<b>PQ</b>
<i>EnErGY</i>	68: EnErGY Submenu	SEt/EnErGY	W/VA/VAr
<i>EnErGYStorE</i>	68: EnErGY StorE – Scope of Stored Values for Power and Energy Measurements	SEt/EnErGY	W/VA/VAr
<i>EVEntS</i>	65: EVEntS – Event Counter Sampling Rate and Trigger Thresholds	SEt/EVEntS	$V_{lim} V_{trig}$
<i>HArM</i>	71: HArM – Harmonic Analysis Parameter	SEt/HArM	$I_{lim} A_{trig} \sim$ (THD)
<i>LoVoLt</i>	69: LoVoLt and HiVoLt – Trigger Thresholds	SEt/MAInS	<b>PQ</b>
<i>HYSt</i>	73: HYSt – Hysteresis (parameter for memory mode operation)	StorE	Memory mode operation
<i>InFo</i>	63: Querying Parameters – InFo Menu (as moving letters)	InFo	Parameters query / all
<i>IntSEt</i>	76: Configuring Interface Parameters	SEt/SYSIEM	Interface
<i>LoVoLt</i>	69: LoVoLt and HiVoLt – Trigger Thresholds	SEt/MAInS	<b>PQ</b>
<i>MAInS</i>	69: MAInS – Mains Disturbance Recording Parameter	SEt/MAInS	<b>PQ</b>
<i>MAInS.F</i>	69: MAInS.F – Select Line Frequency	SEt/MAInS	<b>PQ</b>
<i>MAInS rAnGE</i>	69: MAInS rAnGE – Select a Measuring Range for Mains Disturbance Recording	SEt/MAInS	<b>PQ</b>
<i>OCcUP</i>	63: Querying Parameters – InFo Menu (as moving letters)	InFo	Memory occupancy / all
<i>rAtE</i>	72: rAtE – Transmission and Storage Rate	SEt/EnErGY	Memory mode operation
<i>r_SL</i>	66: r_SL – Set Limit Value for Low-Resistance Measurement	SEt	$\Omega$
<i>SEnd</i>	75: Activating the Continuous Transmission Mode	SEnd	Interface operation
<i>SEt</i>	64: Entering Parameters – SETUP Menu	SEt	Parameters menu
<i>SEtPrt</i>	22: Measurement Data Recording – Memory Mode Operation, STORE Menu Function	StorE	Memory mode operation
<i>StoP</i>		StorE	
<i>StorE</i>	72: StorE Submenu – Parameters for Memory Mode Operation	StorE	

Menus Parameters	Page: Header	Menu / Submenu	Function / Switch Position
SWELL	69: SwELL and diP Limit – Trigger Thresholds for Brief Overvoltages and Undervoltages	SEt/MAInS	PQ
SYSTEM	64: SYSTEM Submenu	SEt/SYStEM	All
tEMP <sub>intErn</sub>	63: tEMP intErn – Query Reference Temperature	InFo	Temp TC/RTD
tEMP <sub>intErn/ExtErn</sub>	67: tEMP intErn/ExtErn – Select Internal or External Reference Junction External Reference Junction: Specified Temperature	SEt	Temp TC/RTD
tEMP <sub>unit</sub>	66: tEMP unit – Select a Unit of Measure for Temperature	SEt	Temp TC/RTD
tIME /dAtE	63: tIME /dAtE – Query Time/Date, 64: tIME – Set Time	SEt/SYStEM	All
trIG	73: trIG – Trigger Conditions for Memory Mode Operation	StorE	Memory Mode Operation
tStorE	74: tStorE – Recording Time (parameter for memory mode operation)	StorE	Memory Mode Operation
vErSion /cALdAt	63: vErSion /cALdAt – Query Firmware Version and Calibration Date	InFo	Parameters query

### 6.3 Querying Parameters – InFo Menu (as moving letters)

#### bAtt – Query Battery Voltage

MEASURE SETUP Info FUNC ENTER bAtt: 2.75 V.

#### vErSion /cALdAt – Query Firmware Version and Calibration Date

MEASURE SETUP Info FUNC ENTER bAtt: ▾ ... ▾ cALdAt: 3 1.02.10  
vEr: 1.00

#### OCCUP – Query Memory Occupancy

MEASURE SETUP Info FUNC ENTER bAtt: s ... s OCCUP: 000.0%

#### tEMP intErn – Query Reference Temperature

The temperature of the internal reference junction is measured with a temperature sensor in close proximity to the input sockets.

#### tIME /dAtE – Query Time/Date

MEASURE SETUP Info FUNC ENTER bAtt: ▾ ... ▾ dAtE: 3 1. 12.2009 (DD.MM.YY)  
tIME: 13:46:56 (hh:mm:ss)

MEASURE SETUP Info FUNC ENTER bAtt: ▾ ... ▾ tEMP<sub>intErn</sub>: 24°C

h = hours, m = minutes, s = seconds

D = day, M = month, Y = year

Date and time must be reentered after replacing the batteries.

### 6.4 Entering Parameters – SETUP Menu

#### 6.4.1 SYSTEM Submenu

##### tiME – Set Time

Entering the correct time makes it possible to acquire measured values in real-time.

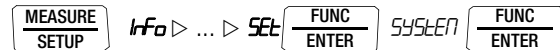

SYSTEM t, ME

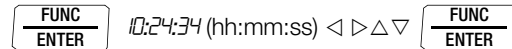

Date and time must be reentered after replacing the batteries.

##### dAtE – Enter Date

Entering the current date makes it possible to acquire measured values in real-time.

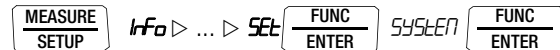

SYSTEM t, ME ▾ ... ▾ dAtE 

dAtE SEt 22.02. (DD: day . MM: month) < > < > < > 

20 10 (YYYY: year) < > < > < > 

Date and time must be reentered after replacing the batteries.

##### Addr – Set Device Address

See section 7.2 on page 76.

##### irStb – Status of the Infrared Receiver in the Stand-By Mode

See section 7.2 on page 76 regarding settings.

##### APoFF – Specified Time for Automatic Shutdown and Continuous On

The instrument is switched off automatically if the measured value remains unchanged for a long period of time and if none of the keys or the rotary switch have been activated before the specified “APoFF” time (entered in minutes) has elapsed.

Automatic shutdown is disabled in the following operating modes: continuous operation, mains analysis, power or energy measurement and whenever dangerous contact voltage ( $U > 30$  V AC or  $U > 35$  V DC) is applied to the input (exception: memory mode).

If the **on** setting is selected, the multimeter is set to continuous operation and **ON** appears in the display to the right of the battery symbol. In this case, the multimeter can only be switched off manually. The “on” setting can only be canceled by changing the respective parameter, or by switching the instrument off manually. In this case, the parameter is reset to 10 minutes.

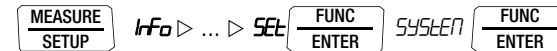

SYSTEM t, ME ▾ ... ▾ SYSTEM APoFF 

APoFF SEt: 1 ... 59 min **on** ▽ ▽ 

(10 minutes = default setting)

### bLiGht – Disable Deactivation of Background Illumination

If necessary, automatic deactivation of background illumination can be disabled with this parameter setting or via the interface.

**MEASURE SETUP** Info ▷ ... ▷ **SET** **FUNC ENTER** *SYSTEM* **FUNC ENTER**

*SYSTEM* **L**, **NE** ▾ ... ▾ *SYSTEM* **bL**, **GHT** **FUNC ENTER**

*bL*, **GHT** **SET**: **APoFF** / **on** △ ▾ **FUNC ENTER**

#### Note

Each time the instrument is switched on, the bLiGht parameter is reset to bLiGht = APoFF!

### 0.diSP – Show/Hide Leading Zeros

This parameter determines whether or not leading zeros will appear in the measured value display.

**MEASURE SETUP** Info ▷ ... ▷ **SET** **FUNC ENTER** *SYSTEM* **FUNC ENTER**

*SYSTEM* **L**, **NE** ▾ ... ▾ *SYSTEM* **0.d**, **SP** **FUNC ENTER** *0.d*, **SP** **SET**:

**00000.0** : with leading zeros (default value)

**0.0** : leading zeros suppressed

△ ▾ **FUNC ENTER**

### 6.4.2 EVEntS Submenu

#### EVEntS – Event Counter Sampling Rate and Trigger Thresholds

An event is recorded whenever at least one measured value has fallen short of the L-trig threshold, and subsequently at least one measured value has exceeded the H-trig threshold. Voltage signals with a repetition frequency of less than 500 Hz, or less than 2 Hz, are recorded (events rate of 0.001 or 0.5 seconds).

**MEASURE SETUP** Info ▷ ... ▷ **SET** **FUNC ENTER** *SYSTEM* ▾ ... ▾ *EVEntS*

**FUNC ENTER** *EVEntS* **tr**, **G** / *EVEntS* **rATE** **DC** △ ▾

**FUNC ENTER** *H-tr* **G** **SET**: **-60000** ... **+60000** △ ▾

**FUNC ENTER** *L-tr* **G** **SET**: **-60000** ... **+60000** △ ▾

**FUNC ENTER** *EVEntS* **rATE**: **0.00** / **0.5** s △ ▾ **FUNC ENTER**

### 6.4.3 General Parameters

#### CLiP – Set Transformation Ratio (current clamp factor)

**MEASURE SETUP** *Info* ▷ ... ▷ **SET** **FUNC ENTER** *SYSTEM* ▾ ... ▾ *CL, P*

**FUNC ENTER** *CL, P SET: 1 / 10 / 100 / 1000 / OFF* ▾ ▾ **FUNC ENTER**

#### bEEP – Set Limit Value for Continuity Testing

**MEASURE SETUP** *Info* ▷ ... ▷ **SET** **FUNC ENTER** *SYSTEM* ▾ ... ▾ *bEEP*

**FUNC ENTER** *bEEP SET: 00 1, 0 10, 0 20 ... 500 Ω* ▾ ▾ **FUNC ENTER**

*in 10 Ohm steps*

(10 Ω = default setting)

#### r\_SL – Set Limit Value for Low-Resistance Measurement

**MEASURE SETUP** *Info* ▷ ... ▷ **SET** **FUNC ENTER** *SYSTEM* ▾ ... ▾ *r\_SL*

**FUNC ENTER** *r\_SL SET: 00.1 ... 00.3 ... 60.9 Ω, 0 L* ▾ ▾ **FUNC ENTER**

(0.3 Ω = default setting)

#### CAP – Scaling Factor for Cable Length Measurement (capacitive linear electric constant)

**MEASURE SETUP** *Info* ▷ ... ▷ **SET** **FUNC ENTER** *SYSTEM* ▾ ... ▾ *CAP*

**FUNC ENTER** *CAP SET: 0 10 nF/km ... 100 nF/km ... 500 nF/km* ▾ ▾

**FUNC ENTER**

(100 nF/km = default setting)

#### dbrEF – Set Reference Value for Alternating Voltage Level Measurement

**MEASURE SETUP** *Info* ▷ ... ▷ **SET** **FUNC ENTER** *SYSTEM* ▾ ... ▾ *dbrEF*

**FUNC ENTER** *dbrEF SET: 00.00 1 ... 99.999 V* ▾ ▾ **FUNC ENTER**

(0.775 V = default setting)

#### tEMP unit – Select a Unit of Measure for Temperature

**MEASURE SETUP** *Info* ▷ ... ▷ **SET** **FUNC ENTER** *SYSTEM* ▾ ... ▾ *tEMP unit*

**FUNC ENTER** *unit SET: °C / °F* ▾ ▾ **FUNC ENTER**

(°C = default setting)



**tEMP intErn/ExtErn – Select Internal or External Reference Junction**

External Reference Junction: Specified Temperature

MEASURE SETUP Info ▷ ... ▷ SET FUNC ENTER SYSTEM ▾ ... ▾ tEMP, nErn

FUNC ENTER tEMP SET: tErn, nErn / tErnPEtErn Δ ▾ FUNC ENTER





EEtErn SET: 000.0 °C Δ ▾ FUNC ENTER

(internal reference = default setting)

### 6.4.4 EnErGY Submenu

#### dEMAnd tiME – Time Interval for Mean Value Generation (parameter for power measurement in memory mode)

The dEMAnd tiME parameter specifies the length of the time period during which measured power is averaged for the display of a mean power value (see section 5.7 on page 47).

 **Info** ▷ ... ▷ **SET**  **SYSTEM** ▾ ... ▾ **EnErGY**  
 **dEMAnd tiME** : 00.0 / 00.02 / 00.05 / 00.10 / 00.15 / 00.20 / 00.30 /  
0 1.00 (hh:mm) △ ▽ 

(15 min = default setting)

#### EnErGY StorE – Scope of Stored Values for Power and Energy Measurements

The StorE parameter (mode) can be used to specify which values will be saved to memory during power and energy measurements when memory mode operation is active. There are three possibilities:

- **Normal (default setting): *Momentary values*** for current, voltage, active, reactive and apparent power, as well as power factor, are acquired and saved to memory at the selected sampling rate (rAtE parameter, at least 0.5 s).
- **Demand: *Mean power values*** for active, reactive and apparent power are saved to memory at the end of each observation period as specified with the dEMAnd tiME parameter.
- **All: *Momentary values*** are saved at the selected sampling rate and ***mean power values*** are saved at the end of each observation period.

### 6.4.5 MAINS Submenu

#### MAInS – Mains Disturbance Recording Parameter

**MEASURE SETUP** Info ▷ ... ▷ **SEt** **FUNC ENTER** *SYSTEM* ▾ ... ▾ *PAR rS*

#### MAInS.F – Select Line Frequency

Selection of the measuring signal line frequency is required for the calculation of the TRMS half-cycle value:

**FUNC ENTER** *PAR rS.F SEt*: 50/60 Hz Δ ▾

#### MAInS rAnGE – Select a Measuring Range for Mains Disturbance Recording

Mains disturbance recording takes place within the specified, fixed measuring range. Exception: Event type +/-trAnS is always detected within the 200 to 1000 V range.

**FUNC ENTER** *rAnGE SEt*: 6.0000/60.000/600.00 V Δ ▾

#### LoVolt and HiVolt – Trigger Thresholds

You can specify the limits within which AC+DC TRMS voltage must lie in the following two displays. If these limits are exceeded or fallen short of, a HiVolt or a LoVolt event is recorded.

These limits are specified in digits independent of range, and 60,000 digits correspond to the full measuring range span.

**FUNC ENTER** *LoVolt Lr Nr t*: 00000...60000 Digit Δ ▾

**FUNC ENTER** *Hi Volt Lr Nr t*: 00000...60000 Digit Δ ▾

#### SwELL and diP Limit – Trigger Thresholds for Brief Overvoltages and Undervoltages

A TRMS half-cycle value is calculated for each of the signal's half-cycles. If this value is less than the selected lower limit (diP Limit) or greater than the upper limit (SwELL Limit), a dip or swell event is recorded.

The entry is made in digits, and 60,000 digits correspond to the full measuring range span.

**FUNC ENTER** *diP Lr Nr t*: 00000...60000 Digit Δ ▾

**FUNC ENTER** *SwELL Lr Nr t*: 00000...60000 Digit Δ ▾

## Device and Measuring Parameters

---

### PEAK LiMit – Maximum Peak Value for Measuring Voltage

The momentary value of the applied signal is measured 1200 times per second and compared with the limit selected here (independent of polarity). If this value exceeds the selected limit, a +/- PEAK event is recorded for the respective half-cycle, and the peak voltage value of the half-cycle is then displayed.

The limit is specified in digits: Due to the fact that this value is the peak voltage value, a value which is greater than the measuring range span (which corresponds to 60,000 digits) can be selected.

 **FUNC**  
ENTER PEAK LiMit: 000 000 ... 100 000 Digit  $\Delta \nabla$   **FUNC**  
ENTER

### Note

Due to the fact that it's possible to record one +PEAK and one -PEAK event for each half-cycle, as many as 200 or 240 events can occur per second if the limit is set too low!

---

### Steep Sloped Voltage Transients

A trigger threshold can be specified here as an absolute value for steep sloped voltage transients which are superimposed to mains voltage. This is a polarity-independent entry relative to the momentary value. Regardless of the selected measuring range, acquisition always takes place within a range of 200 to 1000 V.



 **FUNC**  
ENTER *TRNS LiT: 200 ... 600 V  $\Delta \nabla$*   **FUNC**  
ENTER

### 6.4.6 HArM Submenu

#### HArM – Harmonic Analysis Parameter

In order to analyze the measuring signal's harmonics, its fundamental frequency must be specified with the HARM.F parameter. Due to the fact that the MAN key is used for another purpose in the harmonic analysis function, it cannot be used to switch back and forth between automatic and manual range selection. For this reason, the U.ranGE and I.ranGE parameters are used to specify a measuring range for harmonic analysis:

- **U.Range (I.range) = auto:**  
Automatic range selection is used at the voltage jack (current jack) for harmonic analysis.
- **U.range (I.range) ≠ auto:** Manual range selection is enabled at the voltage jack (current jack) for harmonic analysis, and the selected range is used. The range can be changed with the left and right scroll keys.

 *Info* ▷ ... ▷ *Set*  *SYSTEM* ▾ ... ▾ *HArM*

 *HArM.F Set* : 16.7/50/60/400 Hz △ ▽

 *U.rAnGE Set* : 600 mV/6/60/600 V/Auto △ ▽

 *I.rAnGE Set* : 600 μA/6/60/600 mA/6/ 10 A/Auto △ ▽





#### Note

Clip factor and type are not taken into consideration for this range selection, and the actual measuring range is selected instead.

### 6.4.7 StorE Submenu – Parameters for Memory Mode Operation

#### rAtE – Transmission and Storage Rate

The sampling rate specifies the time interval after which the respective measured value is transmitted to the interface, or to measured value memory.

The following rates (ms values) can be selected:

0.0005 s, 0.001 s, 0.002 s, 0.005 s, 0.01 s, 0.02 s, 0.05 s  
(valid for V DC and A DC only, see section 4.5.1 on page 24)

[mm:ss.z] 00:00.1, 00:00.2, **00:00.5**, 00:01.0, 00:02.0, 00:05.0  
[h:mm:ss.z] (h = hours, m = minutes, s = seconds, z = tenths of a second)

0:00:10, 0:00:20, 0:00:30, 0:00:40, 0:00:50, 0:01:00, 0:02:00, 0:05:00,  
0:10:00, 0:20:00, 0:30:00, 0:40:00, 0:50:00, 1:00:00, 2:00:00, 3:00:00,  
4:00:00, 5:00:00, 6:00:00, 7:00:00, 8:00:00, 9:00:00, SAMPLE, dAtA

#### Setting the Sampling Rate



(00:00.5 = 0.5 s = default value)

The last selected value is retained, even after switching the instrument off.

If the selected **sampling rate** is **too short** for the measuring function, the smallest valid sampling rate is used automatically.

If a **sampling rate** is selected which is **greater than auto power off time** (see APoFF parameter on page 64), the instrument is switched off automatically after auto power off time has elapsed, and back on again roughly 10 seconds before the next measuring point.

#### Storage of Individual Values Using the SAMPLE or dAtA Sampling Rate

If only individually selected values need to be saved, the **SAMPLE** value must be selected as the StorE > rAtE sampling value. If memory mode operation is then started, a single measured value is saved to permanent memory with time stamp when the **DATA/MIN/MAX** key is pressed and held until two rapidly repeating acoustic signals are generated (not in the case of mains analysis).

If **dAtA** is selected as the StorE > rAtE sampling rate, and if memory mode operation is then started, measured values ascertained with activated DATA function are automatically saved to permanent memory with time stamp.

### HYS<sub>t</sub> – Hysteresis (parameter for memory mode operation)

The hysteresis setting allows for efficient use of memory space. During memory mode operation, new measured data are only saved if they deviate from the previously stored value by an amount which exceeds the selected hysteresis value.

Hysteresis can be selected in steps from 1 to 10,000 digits. These digits are related to the measuring range as follows: The position of the set digit in the specified hysteresis value corresponds to the same position within the measuring range, although counting is started at the left

Example: A specified hysteresis of 00100 for the 600.00 V measuring range means that only those measured values which deviate from the last measured value by more than 001.00 V are saved to memory.

 **Note**

Due to the fact that the value is specified in digits (highest place all the way to the left), and thus depends on the measuring range, it's advisable to use the function with a fixed measuring range only.

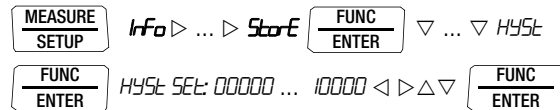

### triG – Trigger Conditions for Memory Mode Operation

The setting StorE > triG SEt = sto-ou / sto-in / off can be used to specify how measured value recording is started and stopped:

- **triG = off:** Recording is started with Store > Start and stopped with Store > Stop.
- **triG = sto-ou:** Recording is started as soon as a measured value occurs which is outside of the selected measuring limits, and is stopped as soon as the measuring limits are once again complied with, or the selected recording period has elapsed.
- **triG = sto-in:** Recording is started as soon as a measured value occurs which is within a specified band, and is stopped as soon as this is no longer the case, or after the maximum recording period has elapsed.

This band is specified with the help of the L\_triG lower limit and the H\_triG upper limit. Querying takes place in the event that trig off is selected. Band widths are specified in digits, and 60,000 digits corresponds to the upper range limit. It's thus advisable to perform measurement with a fixed measuring range. Due to the fact that rapid momentary value acquisition (see section 4.5.1) has a large measuring range span, limit values of greater than 60,000 digits can be selected.

## Device and Measuring Parameters

Actual measurement is always executed using the sampling rate selected in “Store > rAtE”.

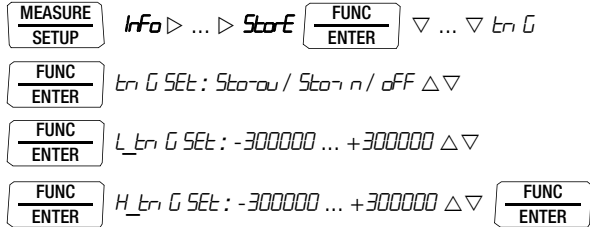

### tStorE – Recording Time (parameter for memory mode operation)

This parameter determines whether or not measured values will be recorded for a limited time only. If recording time will be limited, its duration can be entered in hours, minutes and seconds. “On” means unlimited recording time.





### 6.5 Default Settings (factory settings) – Reset

Previously entered changes can be undone, and default settings can be restored. This may be advisable under the following circumstances:

- After the occurrence of software or hardware errors
- If you are under the impression that the multimeter does not work correctly

#### ➤ Disconnect the device from the measuring circuit.

➤ Remove the batteries temporarily (see also section 9.2).

- Simultaneously press and hold the  and  keys, and connect the battery at the same time.



## 7 Interface Operation

Your instrument is equipped with an infrared interface: Data and commands are transferred through the instrument housing by means of infrared light to an interface adapter (accessory) which is plugged onto the multimeter and connected to a PC via USB.

The multimeter can be controlled by the PC via this interface without any action required from the user (e.g. operation of the rotary switch or keys) in order to:

- Configure and read out measuring parameters
- Select a measuring function and a measuring range
- Start measurement
- Read out stored measured values



### 7.1 Activating the Continuous Transmission Mode

The interface is automatically activated for receiving operation (multimeter receives data from the PC) as soon as the interface is addressed by the PC, assuming that the “*IrStb*” parameter has been set to “*on*” (see section 7.2), or the instrument is already switched on (the first command wakes up the multimeter, but does not yet execute any further commands).

The “continuous transmission” operating mode is selected manually as described below. When set to this operating mode, the instrument continuously transmits the following data at the sampling rate selected under *StorE* > *rAtE*:



- Momentary measured value(s)
- Measuring function
- Measuring range(s)



### Starting Continuous Transmission Operation with Menu Functions

 *IrFo* ▷ ... ▷ *SEnd*  *StArt*  *SEnd* ↓IR↑

The ↓IR↑ symbol blinks at the display in order to indicate interface operation.

### Stopping Continuous Transmission Operation with Menu Functions

 *IrFo* ▷ ... ▷ *SEnd*  *StoP* ↓IR↑

 *StoP* ↓IR↑  *SEnd* ■

The ↓IR↑ symbol is cleared from the display.

### Automatic Activation and Deactivation of Transmission Mode Operation

If the sampling rate is 10 minutes or longer, the display is switched off automatically between samples in order to prolong battery service life. The only exception is when the multimeter is set to continuous operation.

As soon as an event occurs, the display is automatically switched back on, and then off again.

## Interface Operation

### 7.2 Configuring Interface Parameters

#### *rStb* – Status of the Infrared Receiver in the Stand-by Mode

There are two possible switching statuses for the infrared interface when the multimeter is switched off:

*on*: IR appears at the display and the infrared interface is active, i.e. signals such as making commands can be received, and power is consumed even though the multimeter is switched off.

*off*: IR does not appear at the display and the infrared interface is switched off; signals cannot be received.

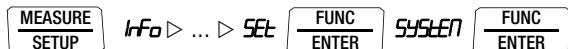

SYSTEM b NE ▾ ... ▾ SYSTEM, rStb

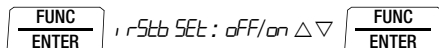

(*on* = default value,  
*off* = status upon delivery)

#### *Addr* – Address

If several multimeters are connected to the PC via an interface adapter, a separate address can be assigned to each instrument. Address number 1 should be selected for the first instrument, 2 should be assigned to the second and so forth.



SYSTEM b NE ▾ ... ▾ SYSTEM Addr



(15 = default setting)

8 Technical Data

Meas. Function	Measuring Range	Resolution at Upper Range Limit		Input impedance		Intrinsic Uncertainty under Ref. Cond. for High Resolution (59,999 digits)			Overload Capacity <sup>2</sup>		
		60,000	6,000	$\equiv$	$\sim / \approx$	$\pm(\dots \% \text{ rdg.} + \dots \text{ d})$	$\pm(\dots \% \text{ rdg.} + \dots \text{ d})$	$\pm(\dots \% \text{ rdg.} + \dots \text{ d})$	Value	Time	
<b>V</b>	60 mV	1 $\mu$ V				$\equiv$	$\sim^1$	$\approx^1$	600 V DC AC TRMS sine	Max. 10 s  Cont.	
	600 mV	10 $\mu$ V		$\geq 17 \text{ M}\Omega$	$\geq 9 \text{ M}\Omega // < 50 \text{ pF}$	0.02 + 15 with ZERO	0.02 + 15 with ZERO	0.2 + 30			1 + 30
	6 V	100 $\mu$ V		$\geq 17 \text{ M}\Omega$	$\geq 9 \text{ M}\Omega // < 50 \text{ pF}$	0.02 + 15		0.2 + 30			1 + 30
	60 V	1 mV		$\geq 17 \text{ M}\Omega$	$\geq 9 \text{ M}\Omega // < 50 \text{ pF}$	0.02 + 15		0.2 + 30			1 + 30
	600 V	10 mV		$\geq 17 \text{ M}\Omega$	$\geq 9 \text{ M}\Omega // < 50 \text{ pF}$	0.02 + 15		0.2 + 30			1 + 30
				<b>Display range where reference voltage U<sub>REF</sub> = 0.775 V</b>			<b>Intrinsic uncertainty</b>				
<b>dB</b>	0.6 ... 600 V~		0.01 dB	-48 dB ... +58 dB			0.1 dB (U > 10% MR)		600 V DC / AC TRMS sine	Cont.	
				<b>Voltage drop at approx. range limit</b>		$\equiv$	$\sim^1$	$\approx^1$			
<b>A</b>	600 mA	10 nA		60 mV	60 mV	0.1 + 20		0.5 + 25	1.0 + 30	0.7 A  10 A: $\leq 5 \text{ min.}^{10}$ 16 A: $\leq 30 \text{ s}^{10}$	
	6 mA	100 nA		160 mV	160 mV	0.05 + 20		0.5 + 25	1.0 + 30		
	60 mA	1 $\mu$ A		180 mV	180 mV	0.05 + 20		0.5 + 25	1.0 + 30		
	600 mA	10 $\mu$ A		250 mV	250 mV	0.1 + 20		0.5 + 25	1.0 + 30		
	6 A	100 $\mu$ A		360 mV	360 mV	0.2 + 30		0.5 + 25	1.0 + 30		
	10 A	1 $\mu$ A		600 mV	600 mV	0.2 + 30		0.5 + 25	1.0 + 30		
<b>A</b> $\approx$	Factor: 1:1/10/100/1000	<b>Input</b>		<b>Input impedance</b>							
	0,06/0,6/6/60 A	60 mA		3 $\Omega$		See A~ current measuring range for specification			Measurement input 0.7 A continuous 10 A: 5 min.		
	0,6/6/60/600 A	600 mA		0,4 $\Omega$		Plus current clamp transformer error					
	6/60/600/6 000 A	6 A		60 m $\Omega$							
<b>A</b> $\approx$	0,6/6/60/600 A	600 mV		Voltage measurement input (V jack) R <sub>i</sub> = 9 M $\Omega$		See V~ <sup>1</sup> voltage measuring range for specification			Measurement input 600 V RMS max. 10 s		
	6/60/600/6000 A	6 V				Plus current clamp sensor error					
	60/600/6000/60000A	60 V									
<b><math>\Omega</math></b>	600 $\Omega$	10 m $\Omega$		<b>Open-circuit voltage</b> Meas. current at range limit		$\pm(\dots \% \text{ rdg.} + \dots \text{ d})$			600 V DC AC TRMS sine	Max. 10 s	
	6 k $\Omega$	100 m $\Omega$		< 1.4 V	Approx. 250 $\mu$ A	0.1 + 5 with ZERO function active					
	60 k $\Omega$	1 $\Omega$		< 1.4 V	Approx. 60 $\mu$ A	0.1 + 5					
	600 k $\Omega$	10 $\Omega$		< 1.4 V	Approx. 7 $\mu$ A	0.1 + 5					
	6 M $\Omega$	100 $\Omega$		< 1.4 V	Approx. 0.8 $\mu$ A	0.2 + 5					
	60 M $\Omega$	1 k $\Omega$		< 1.4 V	Approx. 180 nA	0.5 + 5					
	60 M $\Omega$	1 k $\Omega$		< 1.4 V	Approx. 15 nA	2.0 + 10 (battery operation)					
<b>nS</b>	600 nS	0.1 nS		< 1.4 V	0.45 $\mu$ A	2 + 10 (as of 3% MR)					
<b>RPE</b>	60 $\Omega$	001 $\Omega$		9 V	Approx. 3 mA	1 + 5 with ZERO function active					
<b><math>\omega</math></b>	600 $\Omega$	—	0.1 $\Omega$	Approx. 3.2 V	Approx. 1 mA const.	1 + 5 with ZERO function active					
<b><math>\rightarrow</math></b>	6,0 V <sup>3</sup>	—	1 mV	Approx. 9 V	Approx. 1 mA const.	0.5 + 3					

Meas. Function	Measuring Range		Resolution at Upper Range Limit		Intrinsic Uncertainty under Reference Conditions for High Resolution (59,999 digits)			Overload Capacity <sup>2</sup>		
			60,000	6,000	Discharge res.	$U_{0max}$	$\pm(\dots \% \text{ rdg.} + \dots \text{ d})$	Value	Time	
<b>F</b>	60	nF	—	10 pF	1 M $\Omega$	0.7 V	$1 + 10^4$ with ZERO function active	600 V DC AC TRMS sine	Max. 10 s	
	600	nF	—	100 pF	100 k $\Omega$	0.7 V	$1 + 6^4$			
	6	$\mu$ F	—	1 nF	12 k $\Omega$	0.7 V	$1 + 6^4$			
	60	$\mu$ F	—	10 nF	12 k $\Omega$	0.7 V	$1 + 6^4$			
	600	$\mu$ F	—	100 nF	3 k $\Omega$	0.7 V	$5 + 6^4$			
					$f_{min}^5$	$\pm(\dots \% \text{ rdg.} + \dots \text{ d})$				
<b>Hz (V)</b>	600.00	Hz	0.01	Hz				Hz (V) <sup>6:</sup>	Max. 10 s	
<b>Hz (A)</b>	6.0000	kHz	0.1	Hz	Input impedance, V jack: Ri = 9 M $\Omega$	1	Hz	Hz(A) <sup>6:</sup>		
<b>Hz (A&gt;C)</b>	60.000	kHz	1	Hz		0.05 + 5 <sup>8</sup>		As of 15 % MR for $U \geq 0.18$ V		600 V
<b>Hz (V)</b>	300.00	kHz	10	Hz		10				Hz (A): <sup>7</sup>
<b>MHz</b>	600 Hz ... 1 MHz		0.01 100	Hz			1 ... 100 Hz	0.05 + 5	> 2 V ... 5 V	
<b>%</b>	2.0 ... 98 %		—	0.01 %	15 Hz ... 1 kHz	1 Hz	0.1 MR + 10 d	> 2 V ... 5 V	600 V	Max. 10 s
	5.0 ... 95 %		—	0.01 %	1 ... 10 kHz	1 Hz	0.1 MR per kHz + 10 d	> 2 V ... 5 V		
	10 ... 90 %		—	0.01 %	10 ... 50 kHz	1 Hz	0.1 MR per kHz + 10 d	> 2 V ... 5 V		
							$\pm(\dots \% \text{ rdg.} + \dots \text{ d})$			
<b>°C/°F</b>	Pt100	-200.0 ... +850.0 °C	0.1 °C					0.3 + 10 <sup>9</sup>	600 V DC/AC RMS sine	Max. 10 s
	Pt1000	-150.0 ... +850.0 °C						0.3 + 10 <sup>9</sup>		
	K	-250.0 ... -150 °C						1.0% + 2.0 K <sup>9</sup>		
	(NiCr-Ni)	-150 °C ... +1372.0 °C						1.0% + 0.5 K <sup>9</sup>		

<sup>1</sup> Specified accuracy valid as of 1% of the measuring range for AC, and 3% for AC+DC. See frequency influence on page 81.

<sup>2</sup> At 0 ° ... + 40 °C

<sup>3</sup> Display of up to maximum 6.0 V, "OL" in excess of 5.1 V.

<sup>4</sup> Applies to measurements at film capacitors during battery operation

<sup>5</sup> Lowest measurable freq. for sinusoidal measuring signals symmetric to zero point

<sup>6</sup> Overload capacity of the voltage measurement input: power limiting: frequency x max. voltage  $6 \times 10^6$  V x Hz for  $U > 100$  V

<sup>7</sup> Overload capacity of current measurement input: see current measuring ranges for maximum current values.

<sup>8</sup> Input sensitivity, sinusoidal signal, 10% to 100% MR (mV range: as of 30%)

<sup>9</sup> Plus sensor deviation for measurement with external reference temperature, plus  $\pm 2$  K for internal reference temperature

<sup>10</sup> Off-time > 30 min. and  $T_A \leq 40$  °C

**Key:** d = digit(s), MR = measuring range, rdg. = reading (measured value)

**Crest Factor CF**

Measuring range:  $1.0 \leq CF \leq 11.0$ , resolution: 0.1

Typical (not specified) maximum deviation:

Frequency	CF ≤ 3.0	3.0 < CF ≤ 5.0	5.0 < CF ≤ 10.0
10 to 70 Hz	±02	±0.2	±0.5
70 to 440 Hz	±02	±0.5	Not valid
440 Hz to 1 kHz	±05	Not valid	Not valid
> 1 kHz	Not valid	Not valid	Not valid

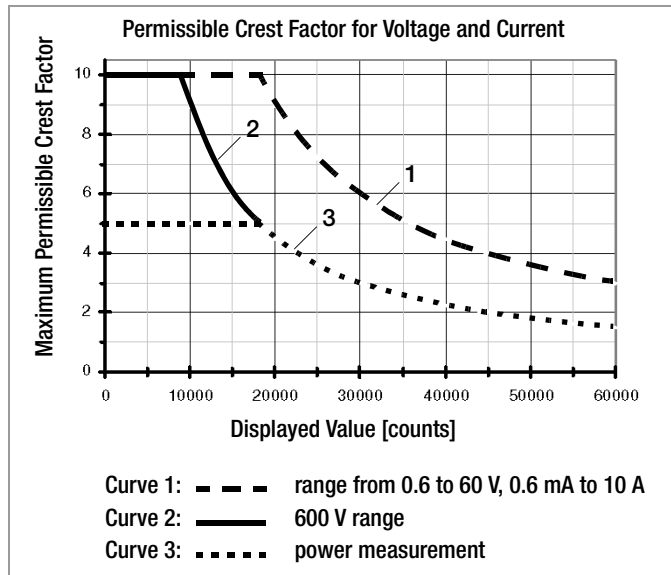

Above figure: Influence of Crest Factor on Display Range

Additional error caused by the signal's crest factor:

$\geq 1,5 < CF \leq 3$       1% rdg.  
 $\geq 3 < CF \leq 5$       3% rdg.

**Power Measurement (measuring ranges for a current clamp factor of 1)  
 – Single-Phase Measurement for Direct and Alternating Current**

Measuring Function	Measuring Range	Resolution at Upper Range Limit	Overload Capacity at 0 ... + 40 °C	
		36,000 counts	Value	Time
<b>W, VAR, VA</b>	360 μW	10 nW	V: 600 V A: 10 A DC AC TRMS sine	V continuous 10 A: 5 min. <sup>2</sup> 16 A: 30 sec. <sup>2</sup>
	3.6 mW	100 nW		
	36 mW	1 μW		
	360 mW	10 μW		
	3.6 W	100 μW		
	36 W	1 mW		
	360 W	10 mW		
	600 W	100 mW		
	3.6 kW	100 mW		
	6 kW	1 W		
	36 kW <sup>1</sup>	1 W		
	360 kW <sup>1</sup>	10 W		
3600 kW <sup>1</sup>	100 W			

<sup>1</sup> Ranges achieved with current clamp only

<sup>2</sup> Off-time > 30 min. and T<sub>A</sub> ≤ 40 °C

### Intrinsic Uncertainty and Frequency Influence for Power and Energy Measurement

Measured Quantity	Measuring Range	Intrinsic Uncertainty $\pm(\dots\% \text{ rdg} + \dots \text{ d})$		
		DC	10 Hz ... 65 Hz	65 Hz ... 1 kHz
Voltage, auxiliary display	$U \geq 0.1 \times U_{\text{max}}$ and $U \geq 0.15 \text{ V}$	0.5 + 10	0.3 + 10	$0.4 + 10^{-1}$
Current, auxiliary display	$I \geq 0.01 \times I_{\text{max}}$	0.2 + 5	0.1 + 5	0.9 + 10
Power factor		1 d	1 d	$+ 1 \text{ d}^{-1}$
Apparent power		1.0 + 20	0.4 + 20	$1.3 + 20^{-1}$
Active power	IPFI $\geq 0.4$ IPFI $< 0.4$	1.0 + 20 —	0.4 + 20 1.0 + 20	$1.5 + 20^{-1}$ $3.0 + 20^{-1}$
Reactive power	IPFI $\leq 0.8$	—	1.0 + 20	$3.0 + 20^{-1}$

<sup>1</sup> Not applicable in mV range

#### Display range

- Current and voltage: 6000 digits
- Apparent, reactive and active power: 36,000 digits
- Power factor: 100 digits

Intrinsic error: stable sinusoidal voltage, stable sinusoidal current, mean voltage value: max. 10% amplitude.  $U > 9\%$  of the upper range limit is usually the case during normal operation due to auto-ranging, except in the smallest range.

Bandwidth up to 1 kHz; signal components of higher frequency are clipped by input filters.

#### Note:

Power is measured with a separate measurement circuit: As a result, specified accuracies for voltage and current measurement do not correspond with the specified values for the respective measuring functions. Principally, DC voltage linearity is only assured with voltages of  $\geq 0.15 \text{ V}$  or  $\geq 10\%$  of the upper range limit.

Additional deviation for U, I during power measurement with higher crest factor,  $f = 0 \dots 65 \text{ Hz}$ :

CF = 2: -0.3% rdg., CF = 3: -0.9% rdg.,  
CF = 4: -1.5% rdg., CF = 5: -2.5% rdg.

#### Square-cycle signal 10 to 65 Hz to U or I:

additional intrinsic uncertainty of +0% / -0.7% rdg.

#### Mains Monitoring / Mains Disturbance Recording

Type of Disturbance	Measuring Range	Resolution (display)	Intrinsic Uncertainty under Reference Conditions with Fixed Frequency of 50/60 Hz	Pulse Time
Over/undervoltage	6 ... 600 V	60,000 digits		
Dip/swell	6 ... 600 V	6000 digits	$\pm(1\% \text{ rdg.} + 1\% \text{ MR})$	$\geq 1 \text{ half-cycle}$
Peak	6 ... 600 V	6000 digits	$\pm(1\% \text{ rdg.} + 2\% \text{ MR})$	$\geq 1 \text{ ms}$
Transient	200 ... 1000 V *	10 V	$\pm 50 \text{ V}$	0.5 ... 5 $\mu\text{s}$

\* Absolute value of the transients is limited to approximately 1000 V by input protection.

#### Internal clock

Time format	DD.MM.YYYY hh:mm:ss
Resolution	0.1 s
Accuracy	$\pm 1 \text{ min./month}$
Temp. influence	50 ppm/K

#### Reference Conditions

Ambient temperature	$+23^\circ \text{C} \pm 2 \text{ K}$
Relative humidity	40 ... 75% (no condensation allowed)
Meas. quantity frequency	45 ... 65 Hz
Meas. quantity waveform	Sine
Battery voltage	1.8 V ... 3.2 V

Influencing Quantities and Influence Error

Influencing Quantity	Sphere of Influence	Measured Quantity/ Measuring Range	Influence Error per 10 K ±(...% rdg. + ... d)
Temperature	0 °C ... +21 °C and +25 °C ... +40 °C	60 mV $\overset{\sim}{\sim}$ <sup>1</sup>	0.2 + 5
		600 mV ... 600 V $\overset{\sim}{\sim}$	0.1 + 5
		600 mV $\overset{\sim}{\sim}$	0.3 + 20
		V $\sim$ , 6 ... 600 V $\overset{\sim}{\sim}$	0.2 + 10
		600 Ω ... 60 MΩ, nS	0.2 + 5
		A $\overset{\sim}{\sim}$ , $\sim$ , $\overset{\sim}{\sim}$	0.2 + 10
		60 nF ... 6 μF, km	1 + 5
		60, 600 μF	3 + 5
		Hz, dB	0.2 + 10
		Diode measurements	0.3 + 5
		RPE measurement	1 + 10
		Pt100 / Pt1000	0.5 + 10
		Type K thermocouple <sup>1</sup>	0.2 + 10
		Power measurement: V	0.3 + 10
		Power measurement: A	0.2 + 5
		W, VA, Wh, VAh	0.5 + 10

<sup>1</sup> The 60 mV DC range and thermocouple measurement are sensitive to temperature fluctuation: For this reason, specified values are not valid until 30 minutes after ambient temperature has stabilized.

Influencing Quantity	Measured Qty. / Measuring Range	Sphere of Influence	Intrinsic Uncertainty <sup>3</sup> ±( ... % rdg. + ... d)
Frequency	600.00 mV	> 15 Hz ... 45 Hz	3 + 30
		> 65 Hz ... 1 kHz	2 + 30
		> 1 kHz ... 20 kHz	3 + 30
		> 20 kHz ... 100 kHz <sup>4</sup>	3.5 + 30 <sup>4</sup>
	V <sub>AC</sub> 6.0000 V ... 60.00 V	> 15 Hz ... 45 Hz	2 + 30
		> 65 Hz ... 1 kHz	1 + 30
		> 1 kHz ... 20 kHz	3 + 30
		> 20 kHz ... 100 kHz <sup>4</sup>	3.5 + 30 <sup>4</sup>
	600.00 V <sup>2</sup>	> 15 Hz ... 45 Hz	2 + 30
		> 65 Hz ... 1 kHz	1 + 30
A <sub>AC</sub> 600.00 mA ... 10.0000 A	> 1 kHz ... 20 kHz	3 + 30	
	> 15 Hz ... 45 Hz	3 + 25	
> 65 Hz ... 10 kHz			

<sup>2</sup> Power limiting: frequency x voltage max.  $6 \times 10^6$  V x Hz for U > 100 V

<sup>3</sup> The accuracy specification for frequency response is valid as of a display value of 10% of the measuring range for both measuring modes with the TRMS converter in the A AC and A (AC+DC) ranges.

<sup>4</sup> Frequency response up to 100 kHz, > 60 kHz plus 5%

Influencing Quantity	Sphere of Influence	Measured Quantity	Influence Error
Relative humidity	75%	V, A, Ω, F, Hz, dB, °C	1 x intrinsic uncertainty
	3 days instrument off		
Battery voltage	1.8 ... 3.2 V	V, A, Ω, F, Hz, dB, °C	Included in intrinsic uncertainty

Influencing Quantity	Sphere of Influence	Measured Quantity/ Measuring Range	Damping
Common mode interference voltage	Interference quantity max. 600 V ~	V $\equiv$	> 120 dB
	Interference quantity max. 600 V ~ 50 Hz ... 60 Hz, sine	6 V ~, 60 V ~	> 80 dB
		600 V ~	> 70 dB
Series-mode interference voltage	Interference quantity V ~, respective nominal value of the measuring range, max. 600 V ~, 50 Hz ... 60 Hz, sine	V $\equiv$	> 50 dB
	Interference quantity max. 600 V —	V ~	> 100 dB

## Data Interface

Type	Optical via infrared light through the housing
Data transmission Protocol	Serial, bidirectional (not IrDa compatible) Device specific
Baud rate	38,400 baud
Functions	<ul style="list-style-type: none"> <li>– Select/query measuring functions and parameters</li> <li>– Query momentary measurement data</li> <li>– Read out stored measurement data</li> </ul>

The USB X-TRA plug-in interface adapter (see accessories) is used for adaptation to the PC's USB port.

## Response Time (after manual range selection)

Measured Quantity/ Measuring Range	Digital Display Response Time	Measured Quantity Jump Function
V $\equiv$ , V ~, dB AV $\equiv$ , A ~	1.5 s	From 0 to 80% of upper range limit value
600 $\Omega$ ... 6 M $\Omega$	3 s	
nS, RPE	3 s	
60 M $\Omega$	8 s	
Continuity (acoustic signal)	< 50 ms	From $\infty$ to 50% of upper range limit value
°C (Pt100)	Max. 3 s	
$\rightarrow$	1.5 s	
60 nF ... 600 $\mu$ F	Max. 2 s	From 0 to 50% of upper range limit value
> 10 Hz	1.5 s	

## Internal Measured Value Storage

Memory capacity	16 MBit for approx. 300,000 measured values with indication of date and time
-----------------	--



## Power Supply

Battery	2 each 1.5 V AA batteries, alkaline manganese per IEC LR6 (2 each 1.2 V NiMH rechargeable batteries also possible)
Service life	With alkaline manganese: approx. 120 hrs.
Battery Indicator	Battery capacity display with battery symbol in 4 segments:  . Querying of momentary battery voltage via menu function.
Power OFF function	The multimeter is switched off automatically: <ul style="list-style-type: none"> <li>– When battery voltage drops below approx. 1.8 V</li> <li>– If none of the keys or the rotary switch are activated for an adjustable duration of 10 to 59 min. and the multimeter is not in the continuous operation mode (assuming the instrument is not set to power measurement or mains analysis)</li> </ul>
Power pack socket	If the NA X-TRA power pack has been plugged into the instrument, the batteries are disconnected automatically. Rechargeable batteries can only be recharged externally. Power pack voltage: 5.1 V $\pm$ 0.2 V

## Display

Transreflective LCD panel (65 x 36 mm) with display of up to 3 measured values, unit of measure, type of current and various special functions.

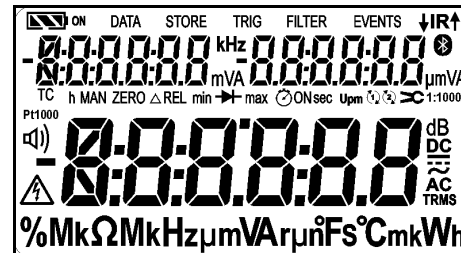

## Background illumination

LED fiber-optic background illumination is switched off approximately 1 minute after it has been activated. If necessary, automatic deactivation of background illumination can be disabled with the appropriate parameter setting or via the interface.

Display / char. height	7-segment characters Main display: 13 mm Auxiliary displays: 7.5 mm
Number of places	60,000 counts/steps
Overflow display	“OL” is displayed as of 61,000 + 1 digits
Polarity display	“–” sign is displayed if plus pole is connected to “⊥”
Sampling rate	10 or 40 measurements per second with the Min-Max function except for the capacitance, frequency, duty cycle and power measuring functions, 2000 measurements per second for fast DC measurement
Refresh rate	V (DC, AC+DC), A, $\Omega$ , $\rightarrow$ , EVENTS AC/DC, count 2 per second Hz, °C (Pt100, Pt1000) 1 to 2 per second °C (J, K) 0.5 per second

## Technical Data

### Acoustic Signals

For voltage	Intermittent signal at above 600 V
For current	Intermittent signal at above 10 A Continuous signal at above 16 A

### Fuse

Fuse link	FF (UR) 10 A/1000 V AC/DC; 10 mm x 38 mm; breaking capacity of 30 kA at 1000 V AC/DC; protects the current measurement input in the 600 $\mu$ A to 10 A ranges
-----------	--

### Electrical Safety

Per IEC 61010-1:2001/VDE 0411-1:2002

Protection class	II	
Measuring category	CAT III	CAT IV
Operating voltage	600 V	300 V
Pollution degree	2	
Test voltage	5.2 kV~	

### Electromagnetic Compatibility (EMC)

Interference emission	EN 61326-1: 2006 class B
Interference immunity	EN 61326-1: 2006 EN 61326-2-1: 2006

### Ambient Conditions

Accuracy range	0 °C to +40 °C
Op. temp. range $T_A$	-10 °C to +50 °C *
Storage temp. range	-25 °C to +70 °C (without batteries)
Relative humidity	40 to 75 %, no condensation allowed
Elevation	To 2000 m
Deployment	Indoors, except within specified ambient conditions

\* Exception: measurement of current > 10 to 16 A, operation at up to 40 °C

### Mechanical Design

Housing	Impact resistant plastic (ABS)
Dimensions	200 x 87 x 45 mm (without rubber holster)
Weight	Approx. 0.4 kg with batteries
Protection	Housing: IP 52 (pressure equalization via housing)

Table Excerpt Regarding Significance of IP-Codes

IP XY (1 <sup>st</sup> digit X)	Protection Against Foreign Object Entry	IP XY (2 <sup>nd</sup> digit Y)	Protection Against Penetration by Water
5	Dust protected	2	Dripping (at angle of 15°)

## 9 Maintenance and Calibration



### Attention!

Disconnect the instrument from the measuring circuit before opening the battery compartment lid or fuse cover in order to replace batteries or fuses!

### 9.1 Displays – Error Messages

Message	Function	Meaning
FUSE	Current measurement	Blown fuse
	In all operating modes	Battery voltage has fallen below 1.8 V
OL	Measuring	Indicates overflow (overload)
ur	Measuring	Indicates that the measuring range has been fallen short of (under range)

### 9.2 Batteries



#### Note

#### Removing the Batteries During Periods of Non-Use

The integrated quartz movement draws power from the batteries even when the instrument is switched off. It's advisable to remove the batteries during long periods of non-use for this reason (e.g. vacation). This prevents excessive depletion of the batteries, which may result in damage under unfavorable conditions.



#### Note

#### Battery Replacement

Stored measurement data are not lost when the batteries are replaced. The selected operating parameters remain in memory, although date and time must be reentered.

#### Charge Level

The current battery charge level can be queried in the “Info” menu:



Make sure that no battery leakage has occurred before initial start-up, as well as after long periods of storage. Continue to inspect the batteries for leakage at short, regular intervals.

If battery leakage has occurred, carefully and completely clean the electrolyte from the instrument with a damp cloth, and replace the battery before using the instrument.

If the “” symbol appears at the display, the batteries should be replaced as soon as possible. You can continue working with the instrument, but reduced measuring accuracy may result.

The instrument requires two 1.5 V batteries in accordance with IEC R 6 or IEC LR 6, or two equivalent rechargeable NiMH batteries.

### Replacing the Batteries



#### Attention!

Disconnect the instrument from the measuring circuit before opening the battery compartment lid in order to replace the batteries.

- ⇨ Set the instrument face down onto the working surface.
- ⇨ Turn the slotted screw on the lid with the battery symbols counterclockwise.
- ⇨ Lift off the lid and remove the batteries from the battery compartment.
- ⇨ Insert two new 1.5 V mignon batteries into the battery compartment, making sure that the plus and minus poles match up with the provided polarity symbols.
- ⇨ When replacing the battery compartment lid, insert the side with the guide hooks first.  
Tighten the screw by turning it clockwise.
- ⇨ Please dispose of depleted batteries in accordance with environmental protection regulations!

### 9.3 Fuse

#### Testing the Fuse

The fuse is tested automatically:

- When the instrument is switched on with the rotary switch in the A position
- When the instrument is already on and the rotary switch is turned to the A position
- In the active current measuring range when voltage is applied

If the fuse is blown or has not been inserted, “FuSE” appears at the digital display. The fuse interrupts the current measuring ranges. All other measuring ranges remain functional.



#### Replacing the Fuse

If a fuse should blow, eliminate the cause of overload before placing the instrument back into service!



#### Attention!

Disconnect the instrument from the measuring circuit before opening the fuse cover in order to replace the fuse!

- ⇨ Set the instrument face down onto the working surface.
- ⇨ Turn the slotted screw on the cover with the fuse symbol counterclockwise.
- ⇨ Lift off the cover and pry the fuse out using the flat side of the fuse cover.
- ⇨ Insert a new fuse. Make sure that the fuse is centered, i.e. between the tabs at the sides.
- ⇨ When replacing the fuse cover, insert the side with the guide hooks first.  
Tighten the screw by turning it clockwise.
- ⇨ Dispose of the blown fuse with the trash.

**Attention!**

Use specified fuses only!

If fuses with other blowing characteristics, other current ratings or other breaking capacities are used, the operator is placed in danger, and protective diodes, resistors and other components may be damaged.

The use of repaired fuses or short-circuiting the fuse holder is prohibited.

**9.4 Housing Maintenance**

No special maintenance is required for the housing. Keep outside surfaces clean. Use a slightly dampened cloth for cleaning. Avoid the use of cleansers, abrasives or solvents.

**9.5 Return and Environmentally Sound Disposal**

The instrument is a category 9 product (monitoring and control instrument) in accordance with ElektroG (German electrical and electronic device law). This device is not subject to the RoHS directive.

We identify our electrical and electronic devices (as of August 2005) in accordance with WEEE 2002/96/EC and ElektroG using the symbol shown at the right per DIN EN 50419.



These devices may not be disposed of with the trash.

Please contact our service department regarding the return of old devices (see address on page 4).

If you use batteries or rechargeable batteries in your instrument or accessories which no longer function properly, they must be duly disposed of in compliance with the applicable national regulations.

Batteries or rechargeable batteries may contain harmful substances or heavy metal such as lead (Pb), cadmium (Cd) or mercury (Hg).

The symbol shown to the right indicates that batteries or rechargeable batteries may not be disposed of with the trash, but must be delivered to collection points specially provided for this purpose.

**9.6 Recalibration**

The respective measuring task and the stress to which your measuring instrument is subjected affect the ageing of the components and may result in deviations from the guaranteed accuracy.

If high measuring accuracy is required and the instrument is frequently used in field applications, combined with transport stress and great temperature fluctuations, we recommend a relatively short calibration interval of 1 year. If your measuring instrument is mainly used in the laboratory and indoors without being exposed to any major climatic or mechanical stress, a calibration interval of 2-3 years is usually sufficient.

During recalibration\* in an accredited calibration laboratory (DIN EN ISO/IEC 17025) the deviations of your instrument in relation to traceable standards are measured and documented. The deviations determined in the process are used for correction of the readings during subsequent application.

## 10 Accessories

### 10.1 General

The extensive accessories available for our measuring instruments are checked for compliance with currently valid safety regulations at regular intervals, and are expanded as required for new applications.

### 10.2 Technical Data for Measurement Cables (KS17-2 safety cable set included with instrument)

#### Electrical Safety

Max. rated voltage  
Measuring category 1000 V CAT III, 600 V CAT IV  
Max. rated current: 16 A

#### Ambient Conditions (EN 61010-031)

Temperature -20 °C ... + 50 °C  
Relative Humidity Max. 80%  
Pollution Degree 2

#### Application

In conformity with standard DIN EN 61010-031, measurements in an environment according to measuring category III and IV may only be performed with the **safety caps** applied to the test probes of the measurement cables.

For establishing contact in 4 mm jacks you have to remove the safety cap by levering out the snap lock of the **safety cap** with another sharp object (e. g. the second test probe).

### 10.3 NA X-TRA Power Pack (Z218G: not included)

Use power packs from GMC-I Messtechnik GmbH only in combination with your instrument. This assures operator safety by means of an extremely well insulated cable, and safe electrical isolation (nominal secondary ratings: 5 V / 600 mA). Installed batteries are disconnected electronically if the power pack is used, and need not be removed from the instrument.



#### Note

Use of the power pack may result in significant deviations during capacitance measurement and in the 60 MΩ range!

---

### 10.4 PMA 16 Power Measuring Adapter (Z228A: not included)

The PMA 16 power measuring adapter is an intermediate plug for safe, trouble-free measurement of power consumption of single-phase consumers connected by means of a plug. The power consumer's protective conductor remains functional during measurement.

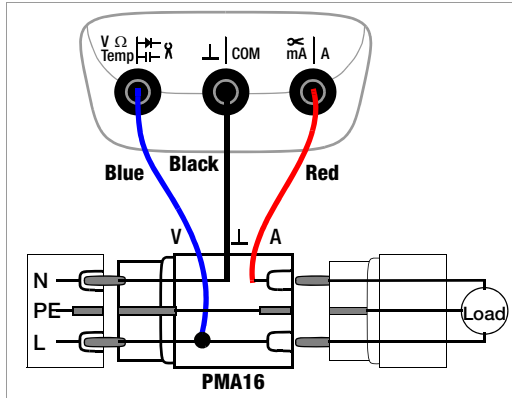

### 10.5 Interface Accessories (not included)

#### USB X-TRA Bidirectional Interface Adapter (Z216C)

E series METRAHIT multimeters which are equipped with a serial IrDa interface can be connected to a USB port at a PC with the adapter. The adapter allows for data transmission between the multimeter and the PC.

#### METRAwin10 PC Analysis Software

**METRAwin10** PC software is a multilingual, measurement data logging program for recording, visualizing, evaluating and documenting measured values from **METRAHIT** multimeters.

The following conditions must be fulfilled in order to allow for use of **METRAwin10**:

#### Hardware, Software and Driver

- IBM compatible Windows PC, 200 MHz Pentium processor or faster with at least 64 MB RAM
- SVGA monitor with at least 1024 x 768 pixels
- Hard disk with at least 40 MB available memory capacity
- CD ROM drive
- Microsoft compatible mouse
- Windows supported printer
- One USB port for use of the **USB X-TRA**
  - with installed driver USB2COM (virtual COM interface) for Windows 2000, XP and VISTA
  - or
  - with Driver Control for Windows XP, VISTA and 7.

## 11 Glossary – Abbreviations of Measuring Functions and Measuring Parameters with their Meanings

Descriptions of the following measuring functions and their use are included in section 5. Descriptions of the following measuring parameters and their settings are included in section 6.

Descriptions of device parameters and their settings (which are not listed here) are included in section 6.



Abbreviation (Sub) Menu Parameter	Meaning	General Description Description Specifically for this Instrument	Application Chapter / Page	Switch Position / Menu
CAP	Scaling factor	A scaling factor (capacitive linear electric constant) must be entered in order to be able to measure cable length in meters or kilometers.	Cable length measurement section 5.6	m SET menu
CF	Crest factor	Relationship of peak value to TRMS value. Measuring range: $1.0 \leq CF \leq 11.0$	Voltage measurement page 25 Current measurement page 52	V <sub>max</sub> , A
CLiP	Current clamp factor	When a current clamp sensor or transformer is connected to the system multimeter (V $\text{A}$ or mA/A $\text{A}$ input) all current displays appear with the correct value in accordance with the selected transformation ratio.	Current clamp measurement section 5.8.2 and section 5.8.3	V, A SET menu
dB	Voltage level	Voltage level measurement is used in order to ascertain overall attenuation or boosting of a transmission system. Where $U_1 = U_{REF} = \text{dbrEF}$ (reference level). Display value > 0 dB: boosting; display value < 0 dB: attenuation Parameter: dbrEF	Alternating voltage level measurement page 32	dB SET menu
dbrEF	Reference level	Reference value for alternating voltage level measurement (see dB).		
dEMAnd tIME	Time interval for mean value generation	This parameter specifies the observation time period for mean value generation during power measurement (see page 50). Acquisition is synchronous to clock time, for which reason the first mean value usually does not span the entire specified duration.	Memory mode operation for power and energy measurement section 4.5.2	W SET menu > EnERGY
diP	Voltage drop	If the TRMS half-wave value falls short of the specified <b>diP LiMit</b> value, a voltage drop (dip) is detected. Parameter: diP LiMit	Power disturbance analysis section 5.1.3	PQ SET menu > MainS
diP LiMit	Voltage drop limit value	See diP Unit of measure in digits, 60,000 = full measuring range		



Abbreviation (Sub) Menu Parameter	Meaning	General Description Description Specifically for this Instrument	Application Chapter / Page	Switch Position / Menu
EVEntS	Submenu for events recording parameters	An event is recorded whenever at least one measured value has fallen short of the L-trig threshold for at least one second, and subsequently at least one measured value has exceeded the H-trig threshold for at least one second. Parameters: L-TriG, H-TriG and rAtE DC	Events recording page 28	V= SEt menu > EVEntS > triG
HArM	Submenu for harmonics parameters	Parameters menu for harmonic analysis: Included parameters: HArM.F (fundamental frequency), U.rAnGE (voltage measuring range) and I.rAnGE (current measuring range).	Harmonic analysis section 5.1.5	 SEt menu > HArM
HArM.F	Fundamental frequency	See HArM Line frequency of the fundamental frequency (here: 16.7, 50, 60 or 400 Hz)		
HiVolt LiMit	Upper trigger threshold	The threshold value for overvoltage (HiVolt LiMit) while monitoring the TRMS voltage value can be entered here in digits. The full measuring range corresponds to 60,000 digits.	Power disturbance analysis section 5.1.3	PQ SEt menu > MainS
H_triG	Upper trigger threshold	See EVEntS	Events recording page 28	V= SEt menu > EVEntS > triG
H_triG	Upper trigger threshold	See StorE	Selective memory mode operation section 4.5	All StorE menu > triG
HYST	Hysteresis	The hysteresis setting allows for efficient use of memory space. During memory mode operation, new measured data are only saved to a new memory block if they deviate from the previously stored value by an amount which exceeds the selected hysteresis value.	Memory mode operation section 4.5	All SEt menu > StorE
I.rAnGE	Current range of the harmonics	See HArM Current range of the harmonics (here: auto, 600 µA, 6, 60, 600 mA, 6 A, 10 A) Note: Clamp factor is not taken into consideration!	Harmonic analysis section 5.1.5	A SEt menu > HArM
LoVolt LiMit	Lower trigger threshold	The threshold value for undervoltage (LoVolt LiMit) while monitoring the TRMS voltage value can be entered here in digits. The full measuring range corresponds to 60,000 digits.	Power disturbance analysis section 5.1.3	PQ SEt menu > MainS
L_triG	Lower trigger threshold	See EVEntS	Events recording page 28	V= SEt menu > EVEntS > triG

## Glossary

Abbreviation (Sub) Menu Parameter	Meaning	General Description Description Specifically for this Instrument	Application Chapter / Page	Switch Position / Menu
L_triG	Lower trigger threshold	See StorE	Selective memory mode operation section 4.5	All StorE menu > triG
<b>MAinS</b>	Submenu for power disturbance analysis parameters	Parameters: MAinS.F, MAinS rAnGE, LoVolt LiMit, HiVolt LiMit, diP LiMit, SWELL LiMit, PEAK LiMit, trAnS LiMit	Power disturbance analysis section 5.1.3	PQ SEt menu > MainS
MAinS rAnGE	Line voltage measuring range	Here: The 6 V, 60 V or 600 V range (default) can be selected as the voltage measuring range.		
MAinS.F	Line voltage frequency	Selection of the measuring signal line frequency is required for the calculation of the TRMS half-wave value: 50 or 60 Hz. It determines whether a TRMS value is generated every 8.33 ms, or every 10 ms.		
nS	Siemens	Unit of measure for electrical conductivity in the SI units system. Reciprocal value of electrical resistance: $S = 1/\text{Ohm} = A/V$ , nS = nanoSiemens	Conductivity measurement section 5.2	Ohm
Peak	Peak value	If the momentary voltage value exceeds the value specified here (regardless of polarity), an exceeded limit value is recorded ( $\pm$ PEAK LiMit).	Power disturbance analysis section 5.1.3	PQ SEt menu > MainS
PEAK LiMit	Peak limit value	See PEAK		
PF	Power factor	Value: Relationship of active power value P to apparent power S Sign: $\pm 1$ : no phase shifting; $-(0 \dots 0.99)$ : capacitive; $+(0 \dots 0.99)$ : inductive	Power measurement section 5.7	W
r_SL	Low-resistance measurement	The resistance of a protective conductor connection limits, for example, the length of an extension cable or a cable reel, or may not exceed a specified limit value. The same applies to resistance between housing and mains plug or device plug. The limit value can be set within a range of 1 to 60 ohms.	Resistance measurement section 5.2	Ohm
rAtE	Sampling rate	The sampling rate specifies the time interval after which the respective measured value is transmitted to the interface, or to measured value memory.	Memory mode operation section 4.5 Interface operation section 6.4.7	All StorE menu

Abbreviation (Sub) Menu Parameter	Meaning	General Description Description Specifically for this Instrument	Application Chapter / Page	Switch Position / Menu
StorE	Main memory for memory mode operation	Parameters: HYSt, rAtE, Sto-ou, Sto-in, L_triG, H_triG, t.StorE  Power and energy measurement in memory mode: section 4.5.2 Scope of stored values for power and energy measurements: section 6.4.4 Mains disturbance recording in memory mode: section 5.1.4	Memory mode operation section 4.5	All StorE menu
SWELL	Overvoltage	If the TRMS half-wave value exceeds the specified limit, a brief overvoltage (swell) is detected. Parameter: SWELL LiMit	Power disturbance analysis section 5.1.3	PQ SET menu > MainS
SWELL LiMit	Overvoltage limit value	See SWELL		
t <sub>E</sub> /t <sub>P</sub>	Duty cycle	The ratio of pulse duration to pulse period is measured with periodic square-wave signals and is displayed as a percentage.  $\text{Duty cycle (\%)} = \frac{\text{Pulse duration (t}_E\text{)}}{\text{Pulse period (t}_P\text{)}} \cdot 100$	Duty cycle measurement section 5.1.6	%
THD	Total harmonic distortion	As a standard feature during harmonic analysis, THD is displayed in accordance with the equation: "THD = total TRMS value of harmonics ÷ TRMS value of the fundamental frequency". As opposed to this, harmonic distortion of the individual harmonics appears in the displays for the individual harmonics. "Distortion component = TRMS value of the harmonic ÷ TRMS value of the fundamental frequency.	Harmonic analysis (voltage) section 5.1.5 Harmonic analysis (current) section 5.8.2 and section 5.8.3	 A
trAnS	Transients	Steep sloped voltage peaks; parameter: trAnS LiMit	Power disturbance analysis section 5.1.3	PQ SET menu > MainS
trAnS LiMit	Transients limit value	A level can be set here as of which a voltage transient is recorded. This is a polarity independent entry relative to the momentary value. The smallest value is 200 V. Regardless of the selected measuring range, acquisition always takes place within a range of 200 ... 1000 V.		
t.StorE	Recording time	Limiting of recording duration (hh:min:ss) to a maximum of 99 hours, 59 minutes and 59 seconds, or unlimited recording time: parameter = on.	Memory mode operation section 4.5	All StorE menu
U.rAnGE	Voltage range of the harmonics	See HArM Voltage range of the harmonics (here: auto, 600 mV, 6 V, 60 V, 600 V) Note: Clamp factor is not taken into consideration!	Harmonic analysis section 5.1.5	 SET menu > HArM

## 12 Index

0.diSP .....	65	Current .....	53	<b>I</b>	
<b>A</b>		Voltage .....	27	Interfaces	
Active Power .....	47	Current Clamp Sensor .....	56, 57	Accessories .....	90
Addr .....	76	Current Measurement		States .....	11
APoFF .....	64	Notes .....	52	irStb .....	76
Apparent Power .....	47	Scope of Functions .....	52	<b>L</b>	
Automatic Shutdown		<b>D</b>		Level Measurement (dB) .....	32
Disabling .....	15	dAtE .....	63, 64	Low-Pass Filter .....	30
Specifying a Time .....	15	dbrEF .....	66	Low-Resistance Measurement .....	39
AUTO-Range Function .....	16	Default Settings .....	74	<b>M</b>	
<b>B</b>		dEMAnd tIME .....	68	MAInS .....	69
Batteries		Device Returns .....	87	Mains Disturbance Recording .....	33
Charge Level Display .....	11	Diode Test .....	42	Mains Monitoring .....	33
Charge Level Query .....	63, 85	Display Illumination .....	14	Maintenance	
Periods of Non-Use .....	85	Duty Cycle Measurement .....	38	Housing .....	87
Replacement .....	86	<b>E</b>		Manufacturer's Guarantee .....	88
bEEP .....	66	Error Messages .....	85	Measured Value Storage	
<b>C</b>		EVEntS .....	28, 65	DATA Function .....	20
Cable Length .....	45	<b>F</b>		Min-Max Values .....	21
Cable Length Measurement .....	46	Firmware Version .....	63	Measurement Cables .....	89
Cable Resistance .....	44	Fuse		Measuring Category	
CAP .....	66	Replacement .....	86	Significance .....	7
Capacitance Measurement .....	45	<b>G</b>		Measuring Range Selection	
Clear		Glossary .....	92	Automatic .....	16
Memory .....	23	<b>H</b>		Manual .....	16
CLiP .....	66	HArM .....	71	Memory	
Conductivity .....	39	Harmonic Analysis .....	54	Ending Recording .....	23
Continuity Test .....	41	HYSt .....	73	Querying Occupancy .....	23
Crest Factor Display				Start Recording .....	22
				Minimum Breaking Capacity .....	52

<b>O</b>		<b>S</b>		<b>U</b>	
OCCUP .....	63	Safety Precautions .....	7	Use for Intended Purpose .....	9
Overview		Sampling Rate (rAtE parameter) .....	72	<b>V</b>	
Keys and Connections .....	10	Scaling Factor .....	46	vErSion .....	63
Parameters .....	62	Scope of Delivery .....	2	Voltage Comparator .....	31
Overtoltage .....	34	Setting the Reference Value .....	19	Voltage Drop .....	34
<b>P</b>		Shutdown		Voltage Measurement	
Peak Value Monitoring .....	17	Automatic (APoFF parameter) .....	64	Notes .....	25
Potentially Explosive Atmospheres .....	7	Automatic (function) .....	15	Scope of Functions .....	25
Power Factor .....	47	Software Enabling .....	3	Voltage Peaks .....	34
Power Pack		Storage Rate (rAtE parameter) .....	72	Voltage Transients .....	70
Accessories .....	89	StorE .....	68	<b>W</b>	
Connector Socket Location .....	13	Switching the Instrument On		WEEE Mark .....	13
Initial Start-Up .....	14	Manual .....	14	<b>Z</b>	
Product Support .....	3	Via PC .....	14	ZERO .....	18
Product Support Hotline .....	3	Symbols		Zero Offset .....	18
<b>Q</b>		Digital Display .....	11		
Quick Measurements (MAN or DATA function) ..	18	Instrument .....	13		
<b>R</b>		Rotary Switch Positions .....	12		
r_SL .....	66	<b>T</b>			
Rapid Momentary Value Acquisition for U DC and I		tEMP intErn .....	63		
DC .....	24	tEMP intErn/ExtErn .....	67		
rAtE .....	72	tEMP unit .....	66		
Reactive Power .....	47	Temperature Measurement			
Recalibration .....	87	With Resistance Thermometers .....	44		
Recalibration Service .....	4	With Thermocouples .....	43		
Relative Measurements .....	18	tiME .....	63, 64		
Remote .....	43	Total Harmonic Distortion THD .....	54		
Repair and Replacement Parts Service .....	4	Transients .....	34		
Reset .....	74	Transmission Rate (rAtE parameter) .....	72		
Resistance .....	39	triG .....	73		
		tStorE .....	74		