

LAUREATE SERIES 2

DIGITAL PANEL METER OWNERS MANUAL



LAUREL Electronics Inc.

1. ORDERING GUIDE

Configure a model number in this format: **L20201DCV1, CBL01**

L...Digital panel meter with screw terminal connectors.

Display Color
1..... DPM with green LED
2..... DPM with red LED
3.... Extended DPM, green LED
4..... Extended DPM, red LED

Note: Extended adds rate of change & linearization of non-linear inputs. Not applicable to thermocouple or RTD inputs.

Power
0.... 85-264 Vac or 90-300 Vdc
1..... 10-48 Vdc or 12-32 Vac

Setpoint Output
0..... None
1..... Two 8A contact relays
2..... Two solid state relays
3..... Four 8A contact relays
4..... Four solid state relays

Analog Output
0..... None
1.... 4-20 mA, 0-10V, -10/+10V

Digital Interface
0..... None
1..... RS232
2..... RS485
4..... RS485-Modbus
5..... USB
6..... USB-to-RS485 gateway
7..... Ethernet
8... Ethernet-to-RS485 gateway

Input Type

DC Volts
DCV1 200.00 mV
DCV2 2.0000 V
DCV3 20.000 V
DCV4 200.00 V
DCV5* 600.0 V
DCV6 300.0 V

DC Amperes

DCA1..... 2.0000 mA
DCA2..... 20.000 mA
DCA3..... 200.00 mA
DCA4..... 5.000 A

RTDs

P385C .. Pt100, -202 to 850°C
P385F..Pt100, -331 to 1562°F
P392C .. Pt100, -202 to 850°C
P392F..Pt100, -331 to 1562°F
N672C ... Ni120, -80 to 260°C
N672F... Ni120, -112 to 500°F
C427C Cu10, -97 to 260°C
C427F.... Cu10, -143 to 500°F

Thermocouples

JC..... -210 to 760°C
JF..... -347 to 1400°F
KC..... -244 to 1372°C
KF..... -408 to 2501°F
TC..... -257 to 400°C
TF..... -430 to 752°F
EC..... -240 to 1000°C
EF..... -400 to 1830°F
NC..... -245 to 1300°C
NF..... -410 to 2370°F
SC..... -46 to 1768°C
SF..... -51 to 3214°F
RC..... -45 to 1768°C
RF..... -49 to 3213°F

Resistance / Ohms

R0.....0-2 ohms (fixed range)
R1.....0-20.000 ohms
R2.....0-200.00 ohms
R3.....0-2.0000 kohms
R4.....0-20.000 kohms
R5.....0-200.00 kohms
R6....0-2 Mohms (fixed range)

Process Signals

(4-20 mA, 0-10V, etc.)
P..... 4-20 mA = 0-100.00
P1..... Custom Scaling

Specify min signal & reading, max signal & reading.

RMS Volts

RMV1.....200.00 mV
RMV2.....2.0000 V
RMV3.....20.000 V
RMV4.....200.00 V
RMV5*600.0 V
RMV6.....300.0 V

RMS Amperes

RMA1.....2.0000 mA
RMA2.....20.000 mA
RMA3.....200.00 mA
RMA4.....5.000 A

Load Cells (6-wire ratio)

WM1.....-99,999 to +99,999

Specify min input signal & displayed reading, and max input signal & displayed reading. Full-scale inputs 20.000 mV to 500.00mV, 10 Vdc excitation.

Options & Accessories

BL..... Blank lens, no button pads.
CBL01 ..RJ11-to-DB9 RS232 cable. Connects meter to PC com port.
CBL02 .. USB-to-DB9 adapter. For use with CBL01.
CBL05 .. USB-cable. Type A male to Type B male.
IPC..... NEMA-4 panel cover.
BOX1 NEMA4 wall mount enclosure.
BOX2 BOX1 plus IPC.
CASE1 .. Benchtop case for 1 meter.
CASE2.. Benchtop case for 2 meters.

* Range not ETL certified

2. TABLE OF CONTENTS

1.	Ordering Guide	2
2.	Table of Contents.....	3
3.	Product Introduction.....	4
4.	Receiving & Unpacking.....	5
5.	Safety Considerations.....	5
6.	Connector Wiring Information	6
7.	Mechanical Assembly	8
8.	Front Panel Setup Keys	10
9.	Enabling & Locking Out Menu Items.....	12
10.	Meter Scaling Theory.....	13
11.	DC Volts, Amps, Process, Strain Input	14
12.	Load Cell & Microvolt Input.....	19
13.	AC RMS Volts & Amps Input	24
14.	Thermocouple Input.....	30
15.	RTD & Resistance Input	34
16.	Dual & Quad Relay Output Options	39
17.	Analog Output Option	42
18.	Serial Communication Options	43
19.	Excitation Output & Power Supply	48
20.	Instrument Setup Via PC	49
21.	Custom Curve Linearization.....	52
22.	Meter Calibration.....	54
23.	Specifications.....	55
24.	Glossary of Terms.....	59
25.	Warranty	64

3. PRODUCT INTRODUCTION

Our digital panel meters are versatile, cost effective solutions to a wide variety of monitoring and control applications. Depending on the choice of signal conditioner, they are easily set up for an accurate display of temperature, pressure, flow, weight, voltage or current, all in appropriate engineering units and with zero and span adjustment when needed. Setup can be via front panel pushbuttons or the meter's serial interface. Selective security lockout of the front panel keys protects against accidental changes to meter setup.

High read rates up to 60 per second (50 for 50 Hz operation) are made possible by Concurrent Slope Conversion, which integrates the signal over an AC power line cycle for maximum noise rejection. High read rates provide accurate peak and valley capture, and quick response for control applications. An adaptive digital filter supplies a time constant for the encountered signal noise level yet responds rapidly to changes that exceed a selected threshold. Self-calibration occurs automatically after every 17th reading.

The standard built-in power supply is a high-voltage switching supply that operates from worldwide AC power or from 90-300 Vdc. A low-voltage supply is optional for power from 24 Vdc, 10-48V batteries, or 12-30 Vac. Both supplies provide an isolated 5, 10 or 24Vdc transducer excitation output.

The meter case conforms to the 1/8 DIN size standard and fits in a 45 x 92 mm panel cutout. It is made of high impact, 94V-0 UL-rated plastic and is watertight to NEMA-4 (IP65) when panel mounted. Mounting is from the front of the panel and requires less than 110 mm behind the panel. Power and signal wiring is via removable plugs conforming to UL61010C safety standards. All output options are isolated from meter and power ground to 250 Vac.

Extended meter versions can [linearize nonlinear inputs](#). Up to 180 data points may be linearized by a computer program that stores setup parameters in nonvolatile memory. Extended meters can also display time rate of change.

Alarm or setpoint control can be provide by an optional board with 2 or 4 relays. These can be 8A mechanical or 120 mA solid state relays. The setpoints may be latching or non-latching, be energized above or below the setpoint, or operate in a fail-safe mode. The relays can operate from the filtered signal to reduce relay chatter or from the unfiltered signal for fastest response.

An isolated analog output of 4-20 mA, 0-20 mA, 0-10V or -10 to +10V can be provided by an optional analog output board. The output is linearized to the display and can operate from the filtered or unfiltered signal input. It can be scaled via front panel pushbuttons or the meter's serial interface.

USB, RS232 or RS485 communications are available with the Modbus RTU protocol or Laurel's simpler Custom ASCII protocol. RS485 operation allows up to 32 meters to be daisy-chained over long distances with no need for a hub. A USB-to-RS485 gateway board allows up to 32 meters to be interfaced to a PC via a single USB cable.

Ethernet communications are supported by two versions of an Ethernet board, both of which support the Modbus TCP protocol. An Ethernet-to-RS485 gateway board allows up to 32 meters to be interfaced to a network via a single Ethernet cable.

Meter programming can be via the meter's front panel or a PC running Windows based [Instrument Setup software](#). A communication board is required in the meter but can be removed following meter setup.

4. RECEIVING & UNPACKING

Your meter was carefully tested and inspected prior to shipment. Should the meter be damaged in shipment, notify the freight carrier immediately. In the event the meter is not configured as ordered or the unit is inoperable, return it to the place of purchase for repair or replacement. Please include a detailed description of the problem.

5. SAFETY CONSIDERATIONS



Warning: Use of this equipment in a manner other than specified may impair the protection of the device and subject the user to a hazard. Visually inspect the unit for signs of damage. If the unit is damaged, do not attempt to operate.

Caution:

- The unit must be connected to a Disconnect switch or a branch-circuit breaker, which must be in a suitable location
- This unit must be powered by 85-264 Vac with the high voltage power supply option, or 10-48 Vdc (12-32 Vac) with the low voltage power supply option. Verify that the proper power option is installed for the power to be used. This meter has no On/Off switch. It will be in operation as soon as power is connected.
- The 85-264 Vac power connector (P1 Pins 1-3) is colored Green to differentiate it from other input and output connectors. The 12-32 Vac (10-48 Vdc) power connector is colored Black.
- Do not make signal wiring changes or connections when power is applied to the instrument. Make signal connections before power is applied. If reconnection is required, disconnect power before such wiring is attempted.
- To prevent electrical or fire hazard, do not expose the instrument to excessive moisture.
- Do not operate the instrument in the presence of flammable gases or fumes; such an environment constitutes a definite safety hazard. This meter is designed to be mounted in a metal panel or a bench or wall mount style case. The spacing around the meter and the ventilation must be sufficient to maintain the ambient temperature at less than 55°C.
- Verify the panel cutout dimensions, and mount according to instructions.

Symbols used



Caution (refer to accompanying documents)



Caution, risk of electric shock.



Equipment protected throughout by double insulation or reinforced insulation.



Earth (ground) terminal.



Both direct & alternating current.

Operating environment:

The meter is Class II (double insulated) equipment designed for use in Pollution degree 2.

6. CONNECTOR WIRING INFORMATION

CONNECTORS

Connectors for signal and power are UL-rated screw-clamp terminal blocks that plug into mating jacks on the printed circuit board. Communication connectors are a single RJ11 plug for RS232, dual RJ11 plugs for RS485, dual RJ45 plugs for RS485 Modbus, or USB.

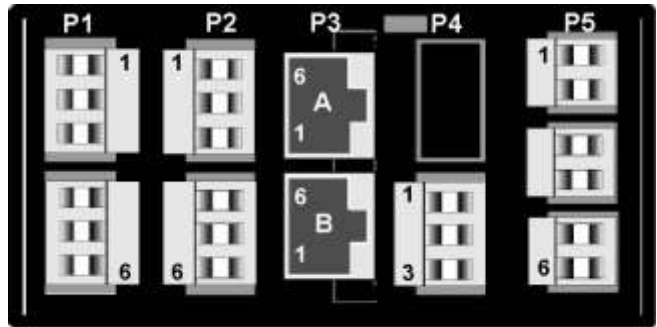

P1 - POWER AND DIGITAL CONTROLS

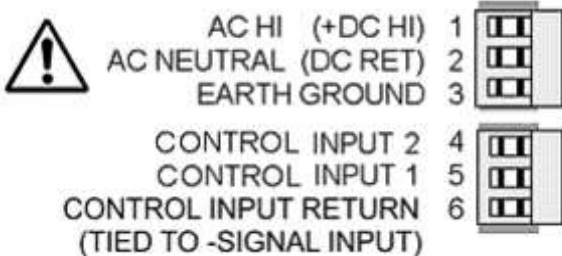

Warning: Hazardous voltages may be present on pins 4, 5 & 6 of P1 since digital ground is tied to pin 3 of P5 (-Signal Input). Keep pin 3 close to earth ground to minimize common mode voltage or shock hazard at pins 4, 5 & 6 of P1.

Note: The functions of control inputs 1 & 2 of P1 are menu selectable.

P5 - SIGNAL INPUT

DC & PROCESS

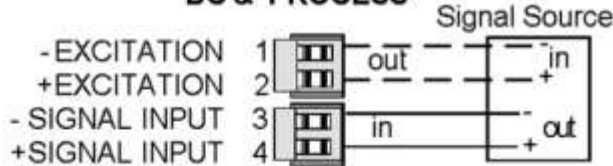

2 WIRE PROCESS TRANSMITTER

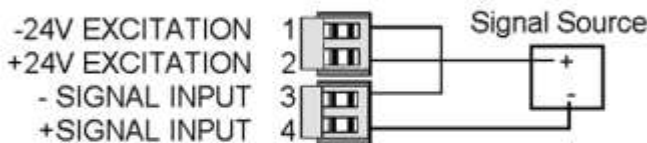

DC RATIO

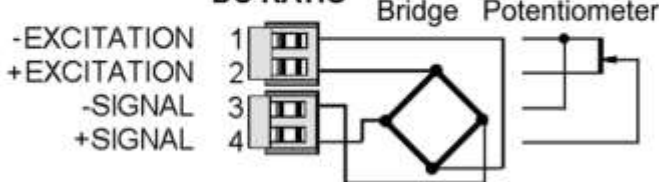

AC (TRUE RMS)

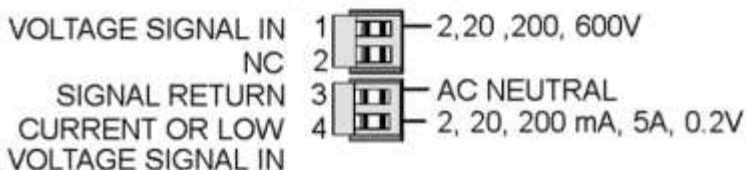

LOAD CELL METER

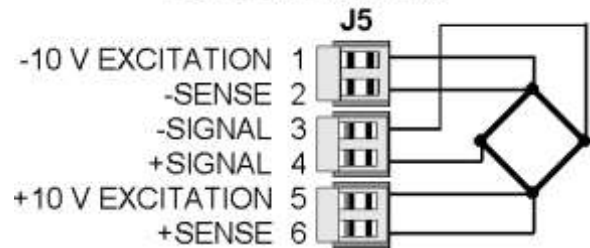

For 4-wire load cell connection, jumper 1 to 2, 5 to 6 at the meter.

RTD & OHMS (2-WIRE)

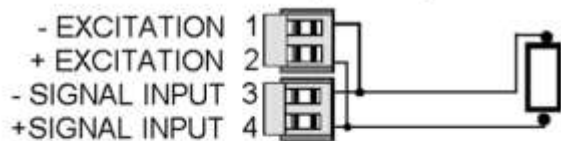

RTD & OHMS (3-WIRE)

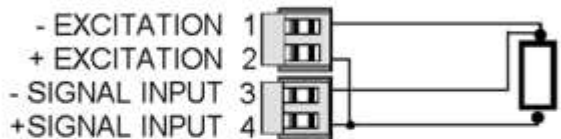

RTD & OHMS (4-WIRE)

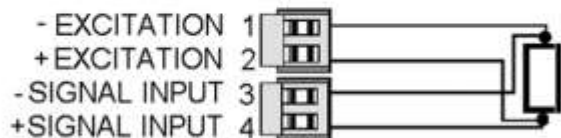

THERMOCOUPLE



P2 - SETPOINT CONTROLLER

DUAL MECHANICAL RELAY OUTPUTS



DUAL SOLID STATE RELAY OUTPUTS

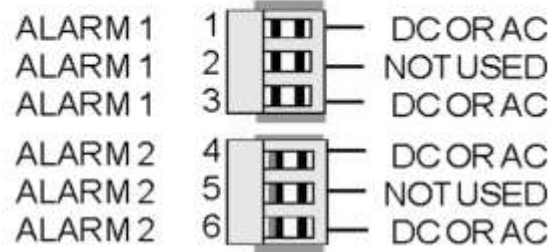

QUAD MECHANICAL RELAY OUTPUTS

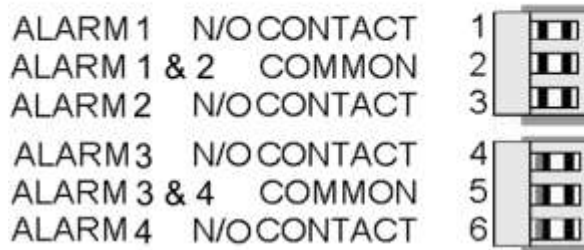

QUAD SOLID STATE RELAY OUTPUTS

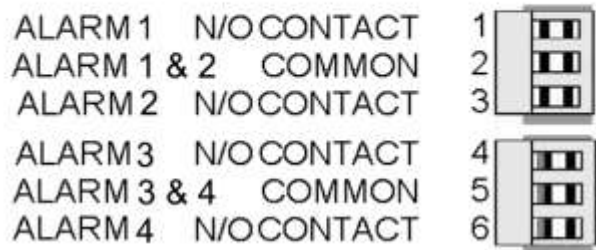

P3 - SERIAL COMMUNICATIONS

RS232 INTERFACE

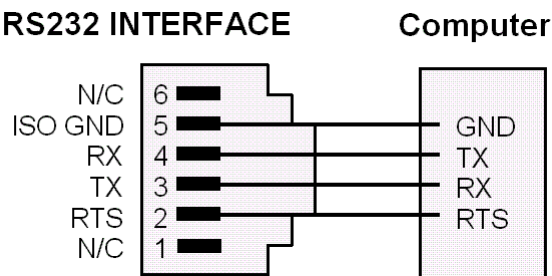

P4 - ANALOG OUTPUT

UNIPOLAR CONNECTIONS

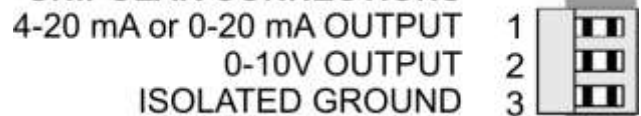

BIPOLAR CONNECTIONS

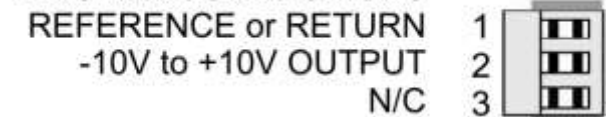

RS485, RJ11, FULL DUPLEX

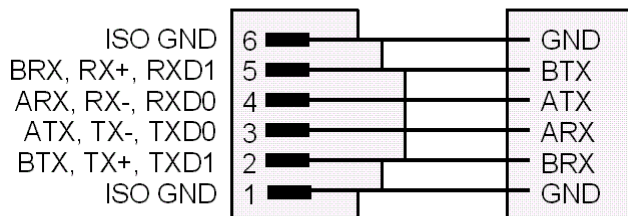

RS485, RJ11, HALF DUPLEX

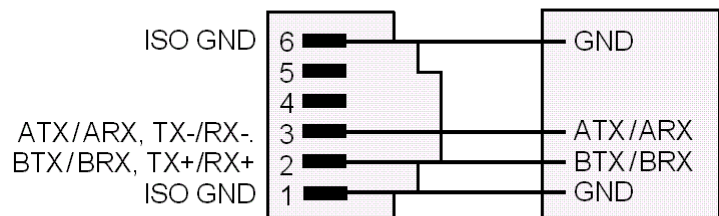

RS485, RJ45, FULL DUPLEX

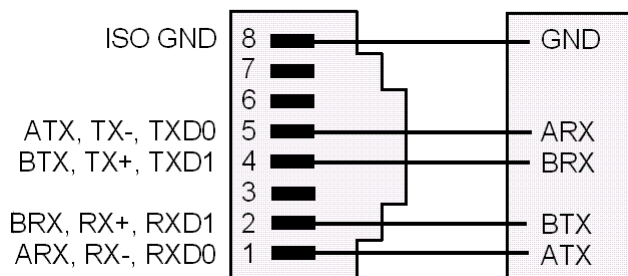

RS485, RJ45, HALF DUPLEX

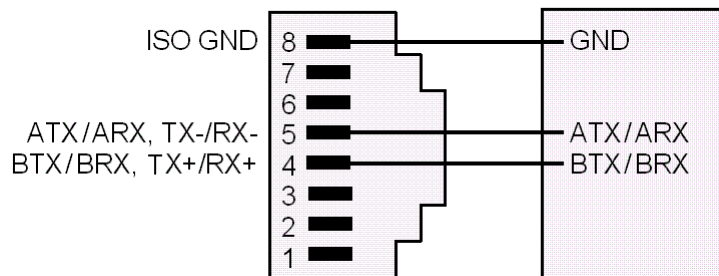

7. MECHANICAL ASSEMBLY

REMOVING THE REAR PANEL

First remove any connectors. Use one hand to press in the two sides of the rear of the case, and the other hand to press down the two protruding tab releases at the top of the rear panel (see figure below). This will unhook the rear panel from the case.

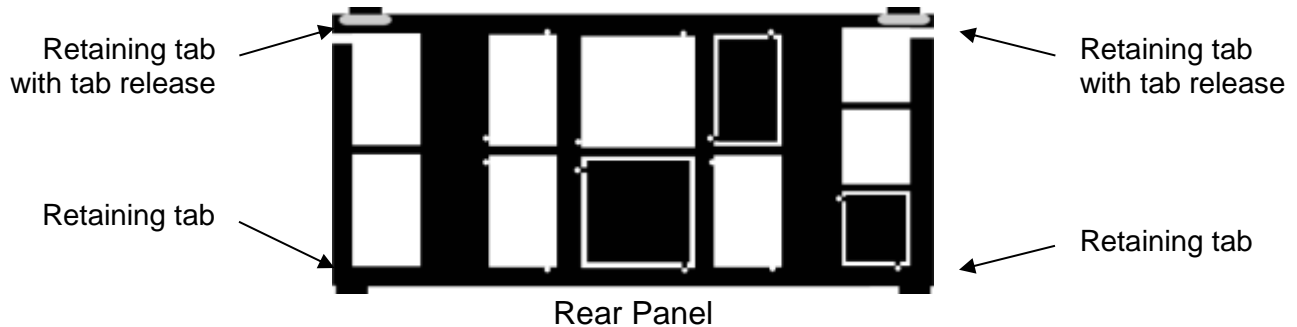

REMOVING THE ELECTRONICS & INSTALLING OPTION BOARDS

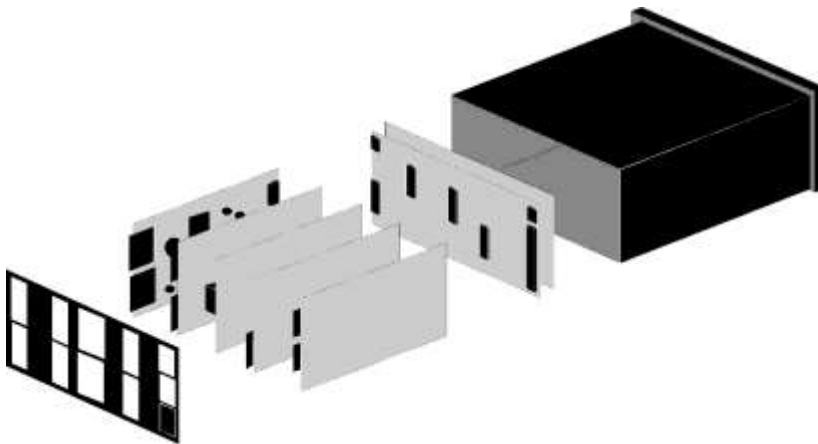

With the rear panel removed, the electronic assembly will easily slide out through the rear of the case.

Options boards plug into the main board at the front of the meter. These are plug-and-play and may be installed in the field. New boards will be recognized by the meter software for access to the appropriate menu items. You may need to remove rear panel knockouts to fit new boards.

Note: When an option board is installed correctly, the top and bottom edges of the main board and option board are aligned. Misaligned boards will burn out the electronics.

Option Board	Main Board Plug	Rear Panel Jack
Power supply	P11	J1
Relay board	P12	J2
Serial interface board	P13	J3
Analog output board	P14	J4
Signal conditioner board	P15	J5

REASSEMBLING YOUR METER

Slide the electronics assembly back into the case until the display board is seated flush against the front of the case. Insert the bottom tabs of the rear panel into the case, and then carefully align the board connectors with the openings in the rear panel. Ensure that all option

boards are properly aligned with the molded board retaining pins on the inside of the rear panel. Once the rear panel is in place, reinstall the input/output screw clamp terminal plugs.

PANEL MOUNTING

Slide the meter into the 45 x 92 mm 1/8 DIN panel cutout. Ensure that the provided gasket is in place between the front of the panel and the back of the meter bezel.

The meter is secured by two pawls, each held by a screw. Turning a screw clockwise extends the pawl outward. Turning the screw clockwise further tightens it against the panel to secure the meter.

Turning a screw counterclockwise loosens the pawl and retracts it into its well. This allows the meter to be inserted into the panel cutout for installation, or to be removed from the panel cutout following installation.

Note: In no case should a screw be removed from its pawl. Doing so would cause the screw and pawl to fall off and likely get lost.

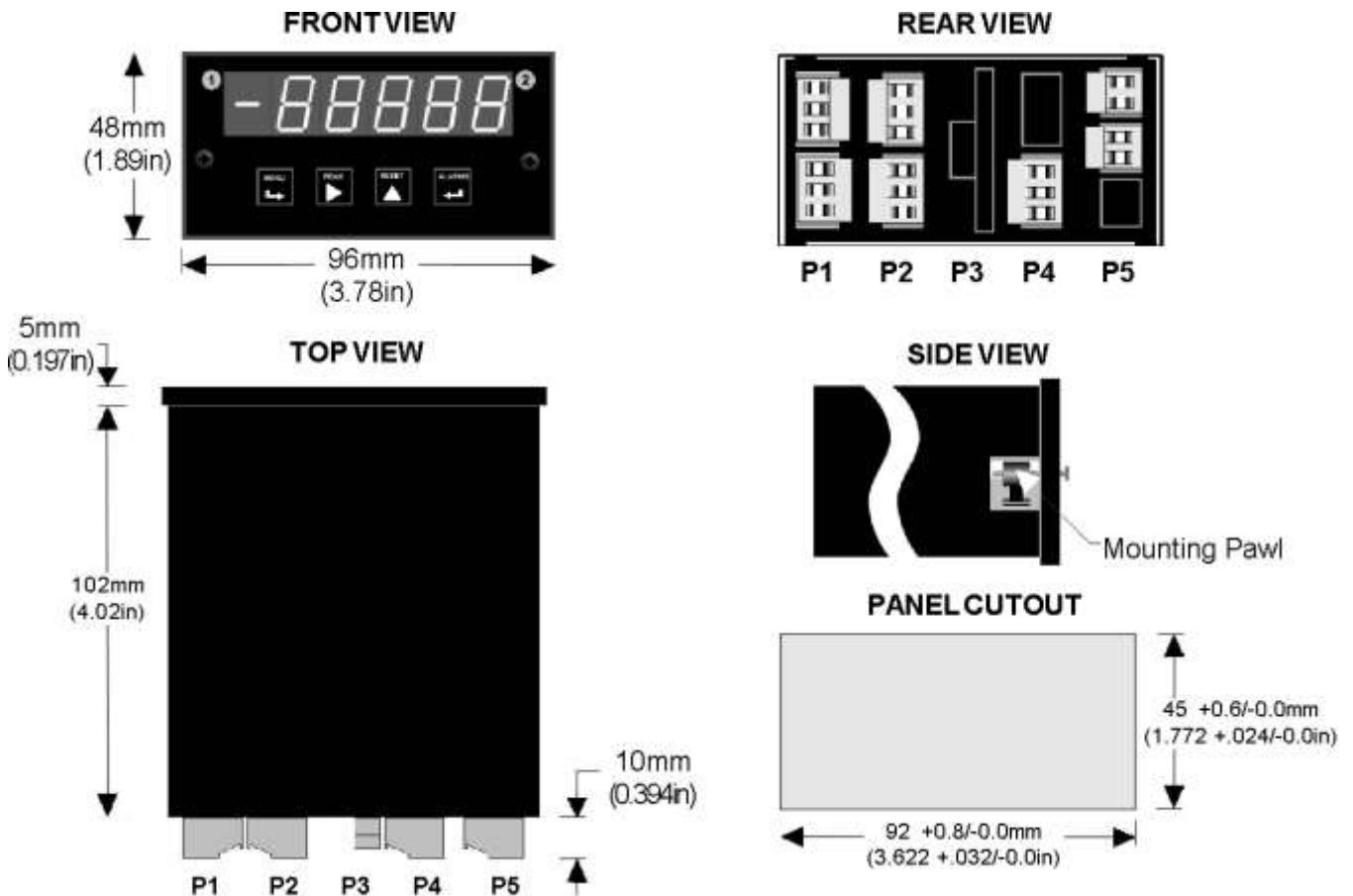
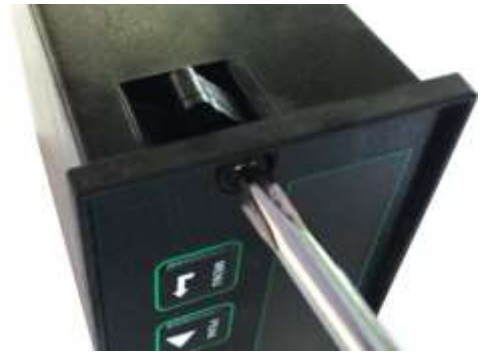

Dimensioned case drawings

8. FRONT PANEL SETUP KEYS



Meter Front Panel

There are four front panel keys, which change function for the **Run Mode** and **Menu Mode**, effectively becoming eight keys. The keys are labeled with alphanumeric captions (MENU, PEAK, RESET, ALARMS) for the Run Mode and with symbols (➡ right arrow, ▶ right triangle, ▲ up triangle, ← left arrow) for the Menu Mode.



FRONT PANEL LOCKOUT

The Menu Mode may not work with meters as received from the factory, because menu items have been disabled in software. Disabling causes menu items not to appear in the menu sequence. To enable menu items, change their lockout status under *Loc 1*, *Loc 2* and *Loc 3* from "0" (locked or disabled) to "1" (unlocked or enabled), as explained in Section 9 of this manual. Also ensure that the lockout jumper is not installed, as explained in that same section. The paragraphs below assume that all menu items have been unlocked.

MENU MODE KEY ACTION

In the Menu Mode, pressing a key momentarily advances to the next menu item. Holding down a key automatically advances through multiple menu items for fast menu navigation.

KEYS IN RUN MODE

-  **MENU Key.** Pressing *MENU* from the Run Mode enters the Menu Mode. Pressing *MENU* repeatedly will step the meter through the various menu items (if these have not been locked out) and then back to the Run Mode.
-  **PEAK Key.** Pressing *PEAK* normally causes the peak value of the input signal to be displayed. The peak display then blinks to differentiate it from the normal present value display. Pressing *PEAK* again returns the display to the present value. The *PEAK* key can also be programmed to display Valley, alternating Peak or Valley, or to Tare the reading to zero. When Peak or Valley is selected, periodic horizontal bars at the top of the display indicate Peak, and periodic horizontal bars at the bottom indicate Valley.
-  **RESET Key.** Pressing *RESET* with *PEAK* resets peak and valley values. Pressing *RESET* with *ALARMS* resets latched alarms. Pressing *RESET* with *MENU* performs a meter reset (same as power on). Meter reset can also be applied via a rear panel connect or a serial ASCII command.



ALARMS Key. Pressing *ALARMS* once displays the setpoint for Alarm 1. Pressing it again displays the setpoint for Alarm 2. Pressing it again returns to the present value.

KEYS IN MENU MODE



Right Arrow Key (MENU). Pressing steps the meter through all menu items that have been enabled and then back to the Run Mode. With the DC signal conditioner board and no option boards, available menu items are **InPut**, **SEtuP**, **ConFG**, **FiLtr**, **dEc.Pt**, **SCALE**, **OFFSt**, **Loc 1**, **Loc 2**, **Loc 3**. If a change has been made to a menu item, that change is saved to non-volatile memory when the key is pressed next, and **StoreE** is displayed briefly.

To return the meter to the run mode after **StoreE** has been displayed, you can press the key repeatedly to step through all top-level menu selections until *rESEt* is displayed briefly. As a shortcut, to return to the run mode after **StoreE** has been displayed, you can press then simultaneously. Again, *rESEt* will be displayed briefly.



Right Triangle Key (Digit Select).

- Pressing from the *InPut* menu brings up all meter functions available with the meter's signal conditioner. For example, for the DC signal conditioner board, these are **dC U**, **dC A** and **rAtio**.
- Pressing from the *SEtuP*, *ConFG*, *FiLtr*, *SCALE*, *OFFSt*, *Loc 1*, *Loc 2* or *Loc 3* menus items sequentially selects digit positions 1 - 5, as indicated by a flashing digit: **00000**, **00000**, **00000**, **00000**, **00000**.
- Pressing from the *dEC.Pt* menu item sequentially selects decimal point positions, which will flash: **d_ddd** **dd_ddd** **ddd_dd** **dddd_d** **ddddd_** **_ddddd**.



Up Triangle Key (Value Select). Pressing for a flashing item (digit position or decimal point position) will increment that item. Pressing will save any changes, and **StoreE** is displayed briefly.



Left Arrow Key (Reverse Menu). Pressing has the same effect as pressing , except that menu items are brought up in reverse order. Pressing repeatedly will backtrack to the previous menu items all the way to meter *rESEt* and return to the run mode.

9. ENABLING & LOCKING OUT MENU ITEMS

For security reasons and ease of meter operation, any or all menu items can be disabled or "locked out" so that they are no longer accessible from the front panel. Each function to be disabled can be set to "1" under menu headers *Loc 1-3*, while each function to be enabled can be set to "0."

Access to the menu headers *Loc 1-3* can be disabled by installing a hardware jumper "a" on the power supply board. With the jumper installed, the operator no longer has access to the menu headers *Loc 1-3*. He can no longer enable or disable menu items, but he still has access to previously enabled menu items. With the jumper removed, the operator has access to menu headers *Loc 1-3* and can enable or disable menu items.

SETTING HARDWARE LOCKOUT JUMPER

To access the lockout jumper, remove the rear panel per Section 9 and locate jumper "a" in the lower portion of the power supply board next to the input connectors (see figure at right).

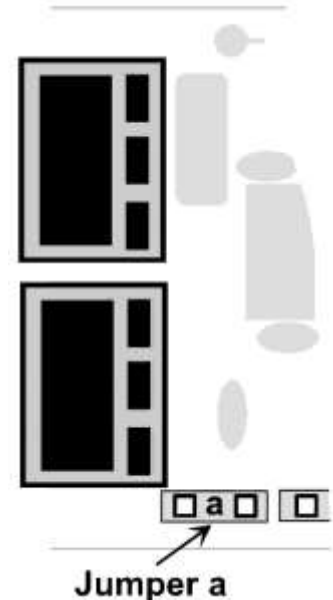

Check lockout status. Many Laurel meters are shipped with lockouts in place. This causes menu items described later in this manual not to appear.



SETTING SOFTWARE LOCKOUTS

To set up a meter, it may be necessary to enable menu items by setting lockout digits to "0". Following setup, reset the digits to "1" if you do not want the menu item to be changed by an operator.

Loc 1 **Loc 2** **Loc 3**

Press the  *MENU* key until *Loc 1*, *Loc 2* or *Loc 3* is displayed, as desired. **Note:** hardware lockout jumper "a" must be removed (see above).

11111

Press  to display the lockout status, consisting of 1's and 0's. The left digit will flash. Press  again to step to the next digit, which will flash.

00000

12345

Press  to set the flashing digit to "0" to enable the menu item or to "1" to disable. Press *MENU* to enter. See the table to the right for list of menu items that can be enabled or disabled.

Enabled or Disabled Menu Items

Loc 1

- 1 - Input type selection.
- 2 - Meter setup, configuration & decimal point
- 3 - Filter selection.
- 4 - Scale or Lo, Hi input.
- 5 - Offset or Lo, Hi reading

Loc 2

- 2 - Alarm setup
- 3 - Alarm setpoint value programming.
- 4 - Analog output scaling.
- 5 - Serial interface setup.

Loc 3

- 2 - View peak or tare value
- 3 - View alarm setpoints
- 4 - Reset (peak & latched alarms)
- 5 - Reset (meter reset)

10. METER SCALING THEORY

User scalability is a standard feature of all of our analog input meters, with the exception of thermocouple and RTD meters. It allows electrical signals to be converted to readings in engineering units. These readings can have up to 5 digits, a user specified decimal point, and a user specified polarity. For example, the same 4-20 mA signal from a pressure transducer can be scaled to display 80.00 to 120.00 psi or 551.6 to 827.4 kPa.

Three scaling methods are user selectable under the meter **SEtUP** programming item:

- 1) Scale and Offset Method, which specifies a straight line of the type $y = mx + b$
- 2) Coordinates of 2 Points Method, which fits a straight line between two data points (low in, low read, and high in, high read).
- 3) Reading Coordinates of 2 Points Method, which uses actual signal inputs instead of manually entered low and high input signals.

Select the scaling method which is most convenient. If you know that the straight line passes through zero, you will typically use the Scale and Offset Method by entering the required scale factor and an offset of zero and. If you are using a calibrated 4-20 mA transducer, you may wish to use the Coordinates of 2 Points Method by entering the desired readings for 4 mA and 20 mA. If you have a load cell meter and a known 50.000 kg weight, you may wish to use the Reading Coordinates of 2 Points Method by entering 0.0000 for no load and 50.000 for the reference weight in place.

Input and display counts are properly rounded integers and are used for scaling regardless of the selected scaling method. The decimal point is not used in calculations but is only a decoration that appears in the displayed reading. For example, 1000 display counts can be shown as 1.000 (kg) or 1000 (grams).

The number of inputs counts is the integer number generated by analog-to-digital conversion. The maximum is 20,000 for full scale (FS) of all signal types and ranges, except for the 50.000 mV load cell range, where the maximum is 50,000. This means that one count is 1 μ A for the 20.000 mA range (which includes 4-20 mA), and 1 μ V for the 50.000 mV load cell range. With the DC signal conditioner, one count is 0.1V for the 300.0V and 600.0V ranges, which are part of the 2000.0V range, and one count is 1 mA for the 5.000A range, which is part of the 20.000A range. Our meter cannot be rated for the full 2000.0V and 20.000A ranges.

The number of display counts is the integer number that is displayed on the meter, is output as serial data, is used to generate the meter's analog output, and is used for relay setpoint comparisons. This is the number generated by the meter's scaling arithmetic.

To increase output resolution and add displayed digits after the decimal point, multiply the input counts by a factor of 10 for each additional digit, then move the decimal point one position to the left for each added digit. For example, if you want to display 517.13 kg instead of 517 kg from a load cell input, increase the scale factor by a factor of 100 to increase the counts to 51713, then move the decimal point to the left by two positions. This change in scaling can also be achieved by entering larger readout numbers using the Coordinates of 2 Points Method or Reading Coordinates of 2 Points Method.

To decrease resolution, for example to display 15,547 mv as 15.5V, divide the scale factor by 10 for each digit to be eliminated. For this example, apply a scale factor of 0.01 to change the counts to 155, and move the decimal point one position to the left.

11. DC VOLTS, AMPS, PROCESS, DC RATIO

The DC Volts, Amps, Process and Strain meters utilize the DC signal conditioner board, which needs to be configured via jumpers for the desired voltage or current range. All signal ranges are factory calibrated with calibration factors stored in EEPROM on the signal conditioner board. The meter software recognizes the board and will bring up the appropriate menu items for it; however, it does not recognize the jumper settings.

Board Revisions Q and R

Ranges	Jumpers		
FS Voltage	E1	E2	E3
±200.00 mV	A	f	b
±2.0000 V	A	f	a
±20.000 V	B	h	b
±200.00 V	B	h	a
±300.0V (ETL)	B	g	a
±600.0V (not ETL)	B	g	a
FS Current	E1	E2	E3
±2.0000 mA	A	e, g	b
±20.000 mA	A	d, g	b
±200.00 mA	A	c, g	b
±5.000 A	A	a, b, g	b

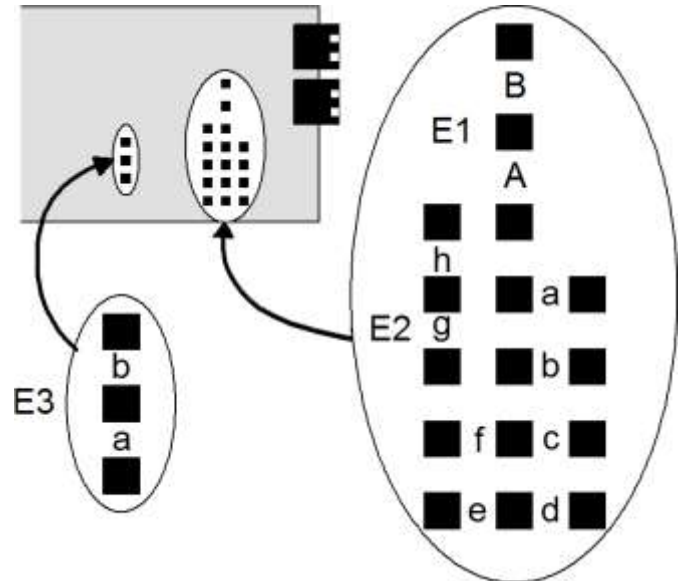

Notes: Position jumpers to cover the gaps marked by a letter. Store spare jumpers on unused jumper posts. Please contact us for board revisions earlier than Q.

For DC voltmeters & ammeters, a scale factor of 1 and an offset of 0 are used for direct readings in (milli)volts or (milli)amperes. This may be displayed as 20.000 mA or 20000 μ A. Decimal point selection does not affect the displayed digits. Full-scale ranges are \pm 20000 counts. For resolution purposes, the 300V and 600V ranges are 2000V (100 mV/count), and the 5A range is 20A (1 mA/count).



Use with a current shunt requires a scale factor to be set. For example, to display 500.0A (5000 output counts) from a 100 mV shunt (10000 input counts in the 200 mV range), apply a scale factor of 0.5 and an offset of 0. Three scaling methods are selectable: 1) Scale and offset, 2) Coordinates of 2 points, and 3) Reading coordinates of 2 points. Only menu items applicable to the selected method are presented.



For use with load cells, select 5V or 10V excitation and from the meter, set **InPut** to **rAtio**, and set the range to 0.2V. The meter will then use the excitation voltage as the reference for A-to-D conversion, thereby correcting for any variations in excitation voltage. The meter can drive four 350-ohm load cells in parallel.

For use with potentiometers where excitation and signal share the same ground, select 5V (not 10V) excitation, set **InPut** to **rAtio**, and set the range to 20V. Again, the meter will use the excitation voltage as the reference for A-to-D conversion, thereby correcting for any variations in excitation voltage. Potentiometers are often used for length measurement.

KEYSTROKES FOR SETUP

If the **MENU**  key does not work, see Section 9 “Enabling & Locking Out Menu Items.”

 MENU Press Menu Select Key	 PEAK Press Digit Select Key	 RESET Press Value Select Key
InPut Selection of signal input type & range. Needs to reflect jumper settings.	dC U DC Volts	0.2U 2.0U 20.0U 200.0U 600.0U 0.2, 2, 20, 200, 600V FS
	dC A DC Amps	2.0a 20.0a 200.0a 5.0a 0.2, 20, 200 mA, 5A FS
	rAtio Strain gauge & ratio	0.2U 2.0U 20.0U 0.2, 2, 20V FS.
SEtUP Meter Setup	00_00 Display selection with scale factor of 1.	0 4-1/2 digits ($\pm 20,000$) 1 5-digit remote display ($\pm 99,999$) 2 4-1/2 digits, counts by 10 ($\pm 20,000$) 3 3-1/2 digits ($\pm 2,000$)
	00_00 Power line frequency	0 Noise minimized for 60 Hz 1 Noise minimized for 50 Hz
	00_00 Scaling method	0 Scale and offset method 1 Coordinates of 2 points method 2 Reading coordinates of 2 points method
	00_00 Rear panel control inputs 1 & 2: True = logic 1 (0V or tied to digital ground) False = logic 0 (5V or open)	0 1 = Reset, 2 = Meter Hold 1 1 = Function Reset, 2 = Peak or Valley 2 1 = Hold, 2 = Peak or Valley Display 3 1 = Hold, 2 = Tare 4 1 = Peak or Valley Display, 2 = Tare 5 1 = Tare, 2 = Reset 6 1 = 1, 2 = 1, decimal point = XXXXX 1 = 0, 2 = 1, decimal point = XXXX.X 1 = 1, 2 = 0, decimal point = XXX.XX 1 = 0, 2 = 0, decimal point = XX.XXX 7 1 = 1, 2 = 1, decimal point = XXXX.X 1 = 0, 2 = 1, decimal point = XXX.XX 1 = 1, 2 = 0, decimal point = XX.XXX 1 = 0, 2 = 0, decimal point = X.XXXX 8 1 = Function Reset, 2 = Display Blank 9 1 = Hold, 2 = Display Blank A 1 = Peak or Valley, 2 = Display Blank B 1 = Tare, 2 = Display Blank C 1 = Valley Display, 2 = Peak Display D 1 = Tare, 2 = Tare Reset
Both inputs 1 and 2 set to 1 for selections 2, 4, A, C = Function Reset (fast, 20 msec). Both inputs 1 and 2 set to 1 for selections 0, 1, 3, 5, 8, 9, B, D = Meter Reset (slow, 2 sec, same as removing & reapplying power).		

MENU  Press Menu Select Key	PEAK  Press Digit Select Key	RESET  Press Value Select Key
ConFG Meter Configuration	000_0 Operation as a rate of change meter. <i>Extended meter only.</i>	0 Not rate of change 1 Rate x 0.1 2 Rate x 1 3 Rate x 10 4 Rate x 100 5 Rate x 1000 6 Rate x 10000
	000_0 Operation of front panel PEAK button and rear connector for Peak or Valley Display	0 Peak Display. Also selects “Peak” in “Peak or Valley” at connector above. 1 Valley Display. Also selects “Valley” in “Peak or Valley” at connector above. 2 Peak (1st push), Valley (2nd push) 3 Front panel Tare
	000_0 Auto-tare	0 Meter comes up in normal run mode. 1 Meter comes up in auto-tare mode.
	000_0 Linear or nonlinear input scaling	0 Linear input 1 Custom curve linearization <i>Extended meter only.</i>
FiLtr Filtering	00000 Alarm filtering	0 Unfiltered output 1 Filtered output
	00000 Peak & Valley filtering	0 Unfiltered Peak & Valley 1 Filtered Peak & Valley
	00000 Display filtering	0 Display 16-reading batch average every 17 readings. Updates display 3.5 times/sec at 60 Hz, 3.0 times/sec at 50 Hz. 1 Display per signal filter setting below.
	00000 Adaptive filter threshold for all filters	0 Low adaptive filter threshold level 1 High adaptive filter threshold level
	00000 Input signal filter setting. <i>Can be applied to display, setpoint, analog output, data output.</i>	0 Autofilter. Time constant set by meter. 1 Batch average of 16 readings 2 Moving average, 0.08 sec time constant. 3 Moving average, 0.15 sec time constant 4 Moving average, 0.3 sec time constant. 5 Moving average, 0.6 sec time constant. 6 Moving average, 1.2 sec time constant. 7 Moving average, 2.4 sec time constant. 8 Moving average, 4.8 sec time constant. 9 Moving average, 9.6 sec time constant. A Unfiltered. Readings updated at 60/sec at 60 Hz, 50/sec at 50 Hz.
dEc.Pt Decimal point selection	d_ddd Decimal point flashes.	d_ddd dd_ddd ddd_dd dddd_d dddd_ _dddd Press ▲ to shift the decimal point.

 MENU Press Menu Select Key	 PEAK Press Digit Select Key	 RESET Press Value Select Key
---	--	---

Scaling method "Scale and Offset" as selected under **SEtUP**

SCALE Scale factor with decimal point	0.0000 0.0000 0.0000 0.0000 0.0000 0.0000 Select digit then dec pt	Select -9 thru 9 for first flashing digit, 0 thru 9 for flashing other digits. Then press ▲ key to move flashing decimal point.
OFFst Offset value	0.0000 0.0000 0.0000 0.0000 0.0000 Select digit to flash.	Select -9 thru 9 for flashing first digit, 0 thru 9 for other flashing digits. Decimal point location is selected by dEC.Pt .

Scaling method "Coordinates of 2 points" if selected under **SEtUP**

Lo In Low signal input.	0.0000 0.0000 0.0000 0.0000 0.0000 Select digit to flash.	Select -9 thru 9 for flashing first digit, 0 thru 9 for other flashing digits. Decimal point is set by input range chosen.
Lo rd Desired reading at Lo In.	0.0000 0.0000 0.0000 0.0000 0.0000 Select digit to flash.	Select -9 thru 9 for flashing first digit, 0 thru 9 for other flashing digits. Decimal point is set by dEC.Pt .
Hi In High signal input.	0.0000 0.0000 0.0000 0.0000 0.0000 Select digit to flash.	Select -9 thru 9 for flashing first digit, 0 thru 9 for other flashing digits. Decimal point is set by input range chosen.
Hi rd Desired reading at Hi In.	0.0000 0.0000 0.0000 0.0000 0.0000 Select digit to flash.	Select -9 thru 9 for flashing first digit, 0 thru 9 for other flashing digits. Decimal point is set by dEC.Pt .

Scaling method "Reading coordinates of 2 points" if selected under **SEtUP**.
When this method is selected, the four menu items below will appear ahead of all other menu items when the **MENU** or **↩** key is first pressed from the run mode. See next page.

Lo In Low signal input. Press ▶ key.	0.021 Apply low reference signal to meter.	0.021 Press ▲ key to store low signal input in meter, then press ↩ Menu key.
Hi In High signal input. Press ▶ key.	20.094 Apply high reference signal to meter.	0.021 Press ▲ to store high signal input meter, then press ↩ Menu key.
Lo rd Desired reading at Lo In. Press ▶ key.	0.0000 0.0000 0.0000 0.0000 0.0000 Modify flashing digit.	0.0000 Select -9 thru 9 for flashing first digit, 0 thru 9 for other flashing digits (decimal point is set by dEC.Pt), then press ↩ Menu key.
Hi rd Desired reading at Hi In. Press ▶ key.	0.0000 0.0000 0.0000 0.0000 0.0000 Select digit to flash.	6.7500 Select -9 thru 9 for flashing first digit, 0 thru 9 for other flashing digits (decimal point is set by dEC.Pt), then press ↩ Menu key.

Reading Coordinates of 2 Points Scaling Method

This scaling method applies a straight line fit between two points, which are based on actual transducer signals. A low input signal, such as the signal with zero weight, and a high input signal, such as the signal with a known weight, are applied to the meter. The corresponding desired low and high readings are then entered from the front panel. The meter applies straight line fit between these low and high calibration points. This scaling method has the advantage of calibrating the transducer and meter as a system. The actual voltages or currents at the two endpoints do not need to be known. This method can be used with DC, process and load cell meters when known inputs are available. It is also available for AC meters, but not thermocouple or RTD meters.

Option board dependent menu items
ALSEt ALS34 dEU1H dEU2H dEU1b dEU2b dEU3H DEU4H DEU3b DEU4b Menu items related to alarm setup . These will only appear if a relay board is detected. If so, see Section 16.
AnSEt An Lo An Hi Menu items related to analog output setup . These will only appear if an analog output board is detected. If so, see Section 17.
SEr 1 SEr 2 SEr 3 SEr 4 Addr Menu items related to communications . These will only appear if an RS232, RS485, USB or Ethernet board is detected. If so, see Section 18.
Menu lockout items
Loc 1 Loc 2 Loc 3 Menu items used to enable or lock out (hide) other menu items . Loc menu items may in turn be locked out by a hardware jumper on the power supply board. See Section 9.

12. LOAD CELL & MICROVOLT INPUT

Load Cell, Strain Gauge and Microvolt meters utilize the load cell signal conditioner board, which offers sensitivity to ± 20 mV full scale and 4 or 6-wire load cell connection. This board needs to be configured via jumpers for the desired voltage range. All signal ranges are factory calibrated with calibration factors stored in EEPROM. The meter software recognizes the board and will bring up the appropriate menu items for it; however, it does not recognize the jumper settings. Please see further manual sections for setup of the following features: [relay output](#), [analog output](#), [communications](#), and [transducer excitation output](#).

RANGE SELECTION VIA JUMPERS

Ranges & Display with Scale Factor = 1

Input	Jumpers	Counts
± 20.000 mV	e	± 20000
± 50.000 mV	a	± 50000
± 100.00 mV	b	± 10000
± 250.00 mV	c	± 25000
± 500.00 mV	d	± 50000

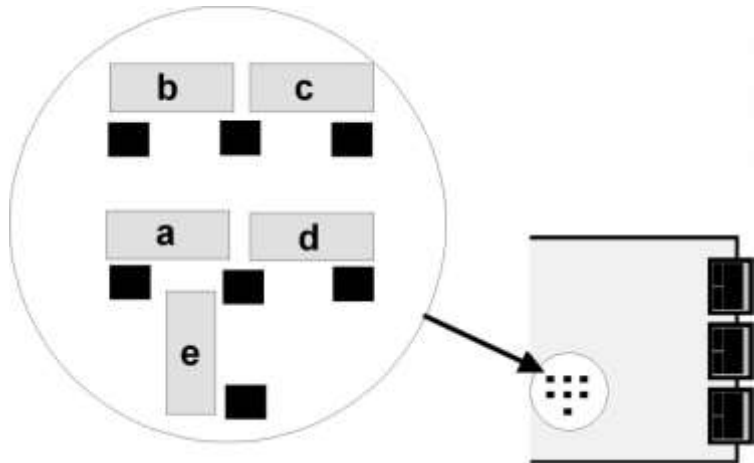

- Notes**
1. See Section 19 to select 10V excitation.
 2. Jumpers are 2.5 mm (0.1 in).

SCALE & OFFSET SETUP



For absolute readings in millivolts or microvolts, select **dC u** under **InPut**. Also select a scale factor of 1 and an offset of 0. A full scale reading is 20,000 counts. Decimal point selection does not affect the displayed digits. For example, 20 mV can be displayed as 20.000 mV or 20000 μ V.



For ratiometric readings with bridges, such as load cells, select **Strn** under **InPut**. Scaling is normally set up from the front panel using the **▶** and **▲** keys, but can also be set up via RS232/485 using our PC compatible setup software (available at no charge). A full scale reading is 20,000 counts. Three scaling methods are selectable: 1) Manual scale and offset, 2) Coordinates of 2 points, and 3) Reading coordinates of 2 points. Please see the Glossary for an explanation of each method.



The reading coordinates of 2 points scaling method applies a straight line fit between two points, which are based on actual transducer signals. A low input signal, such as the signal with zero weight, and a high input signal, such as the signal with a known weight, are applied to the meter. The corresponding desired low and high readings are then entered from the front panel. The meter applies straight line fit between these low and high calibration points. This scaling method has the advantage of calibrating the transducer and meter as a system. The actual voltages or currents at the two endpoints do not need to be known. This method can be used with DC, process and load cell meters when known inputs are available. It is also available for AC meters, but not thermocouple or RTD meters.

KEYSTROKES FOR SETUP

If the **MENU**  key does not work, see Section 9 “Enabling & Locking Out Menu Items.”

 MENU Press Menu Select Key	 PEAK Press Digit Select Key	 RESET Press Value Select Key
InPut Selection of signal input type & range. Needs to reflect jumper settings.	Strn Strain or ratiometric	20.0 50.0 100.0 250.0 500.0 20, 50, 100, 250, 500 mV FS voltage
	dC u DC millivolts	20.0 50.0 100.0 250.0 500.0 20, 50, 100, 250, 500 mV FS voltage
SEtUP Meter Setup	00_00 Display type	0 4-1/2 digit meter, counts by 1 1 5-digit remote display (±99,999) 2 4-1/2 digit meter, counts by 10 3 3-1/2 digit meter
	00_00 Power line frequency	0 Noise minimized for 60 Hz 1 Noise minimized for 50 Hz
	00_00 Scaling method	0 Scale and offset method 1 Coordinates of 2 points method 2 Reading coordinates of 2 points method
	00_00 Rear panel control inputs 1 & 2. True = logic 1 (0V or tied to digital ground) False = logic 0 (5V or open)	0 1 = Reset, 2 = Meter Hold 1 1 = Function Reset 2 = Pk or Valley Disp. 2 1 = Meter Hold 2 = Pk or Valley Disp. 3 1 = Meter Hold 2 = Tare 4 1 = Peak or Valley 2 = Tare 5 1 = Tare 2 = Reset 6 1 = 0, 2 = 0, decimal point 1 = XXXXX 1 = 1, 2 = 0, decimal point 1 = XXXX.X 1 = 0, 2 = 1, decimal point 1 = XXX.XX 1 = 1, 2 = 1, decimal point 1 = XX.XXX 7 1 = 0, 2 = 0, decimal point 2 = XXXX.X 1 = 1, 2 = 0, decimal point 2 = XXX.XX 1 = 0, 2 = 1, decimal point 2 = XX.XXX 1 = 1, 2 = 1, decimal point 2 = X.XXXX 8 1 = Function Reset 2 = Display Blank 9 1 = Hold 2 = Display Blank A 1 = Peak or Valley 2 = Display Blank B 1 = Tare 2 = Display Blank C 1 = Valley Display 2 = Peak Display D 1 = Tare 2 = Tare Reset
Both inputs 1 and 2 set to 1 for selections 2, 4, A, C = Function Reset (fast, 20 msec). Both inputs 1 and 2 set to 1 for selections 0, 1, 3, 5, 8, 9, B, D = Meter Reset (slow, 2 sec, same as removing & reapplying power).		

 Press Menu Select Key	 Press Digit Select Key	 Press Value Select Key
ConFG Meter Configuration	000_0 Operation as a rate of change meter. <i>Extended meter only.</i>	0 Not rate of change 1 Rate x 0.1 2 Rate x 1 3 Rate x 10 4 Rate x 100 5 Rate x 1000 6 Rate x 10000
	000_0 Operation of front panel PEAK button and rear connector for Peak or Valley Display	0 Peak Display. Also selects “Peak” in “Peak or Valley” at connector above. 1 Valley Display. Also selects “Valley” in “Peak or Valley” at connector above. 2 Peak (1st push), Valley (2nd push) 3 Front panel Tare
	000_0 Auto-tare	0 Meter comes up in normal run mode. 1 Meter comes up in auto-tare mode
	000_0 <i>Extended meter only.</i>	0 Linear input 1 Custom curve linearization
FiLtr Filtering	00000 Alarm filtering	0 Unfiltered output 1 Filtered output
	00000 Peak & Valley filtering	0 Unfiltered Peak & Valley 1 Filtered Peak & Valley
	00000 Display filtering	0 Display 16-reading batch average every 17 readings. Updates display 3.5 times/sec at 60 Hz, 3.0 times/sec at 50 Hz. 1 Display per signal filter setting below
	00000 Adaptive filter threshold for all filters	0 Low adaptive filter threshold level 1 High adaptive filter threshold level
	00000 Input signal filter setting <i>Can be applied to display, setpoint, analog output, data output.</i>	0 Autofilter. Time constant set by meter. 1 Batch average of 16 readings 2 Moving average, 0.08 sec time constant. 3 Moving average, 0.15 sec time constant 4 Moving average, 0.3 sec time constant. 5 Moving average, 0.6 sec time constant. 6 Moving average, 1.2 sec time constant. 7 Moving average, 2.4 sec time constant. 8 Moving average, 4.8 sec time constant. 9 Moving average, 9.6 sec time constant. A Unfiltered. Readings updated at 60/sec at 60 Hz, 50/sec at 50 Hz.
dEc.Pt Decimal point selection	d_ddd Decimal point flashes.	d_ddd dd_ddd ddd_dd dddd_d dddd_ _dddd

 Press Menu Select Key	 Press Digit Select Key	 Press Value Select Key
Scaling method "Scale and Offset" if selected under SEtUP		
SCALE Scale factor	0.0000 0.0000 0.0000 0.0000 0.0000 0.0000 Select digit then dec pt	Select -9 thru 9 for first flashing digit, 0 thru 9 for flashing other digits. Then press ▲ key to move flashing decimal point.
OFFst Offset value	0.0000 0.0000 0.0000 0.0000 0.0000 Select digit to flash.	Select -9 thru 9 for flashing first digit, 0 thru 9 for other flashing digits. Decimal point location is selected by dEC.Pt .
Scaling method "Coordinates of 2 points" if selected under SEtUP		
Lo In Low signal input.	0.0000 0.0000 0.0000 0.0000 0.0000 Select digit to flash.	Select -9 thru 9 for flashing first digit, 0 thru 9 for other flashing digits. Decimal point is set by input range chosen.
Lo rd Desired reading at Lo In.	0.0000 0.0000 0.0000 0.0000 0.0000 Select digit to flash.	Select -9 thru 9 for flashing first digit, 0 thru 9 for other flashing digits. Decimal point is set by dEC.Pt .
Hi In High signal input.	0.0000 0.0000 0.0000 0.0000 0.0000 Select digit to flash.	Select -9 thru 9 for flashing first digit, 0 thru 9 for other flashing digits. Decimal point is set by input range chosen.
Hi rd Desired reading at Hi In.	0.0000 0.0000 0.0000 0.0000 0.0000 Select digit to flash.	Select -9 thru 9 for flashing first digit, 0 thru 9 for other flashing digits. Decimal point is set by dEC.Pt .
Scaling method "Reading coordinates of 2 points" if selected under SEtUP . When this method is selected, the four menu items below will appear ahead of all other menu items when the <i>MENU</i> or ↩ key is first pressed from the run mode.		
Lo In Low signal input. Press ▶ key.	0.021 Apply low reference signal to meter.	0.021 Press ▲ key to store low signal input in meter, then press ↩ Menu key.
Hi In High signal input. Press ▶ key.	20.094 Apply high reference signal to meter.	0.021 Press ▲ to store high signal input meter, then press ↩ Menu key.
Lo rd Desired reading at Lo In. Press ▶ key.	0.0000 0.0000 0.0000 0.0000 0.0000 Modify flashing digit.	0.0000 Select -9 thru 9 for flashing first digit, 0 thru 9 for other flashing digits (decimal point is set by dEC.Pt), then press ↩ Menu key.
Hi rd Desired reading at Hi In. Press ▶ key.	0.0000 0.0000 0.0000 0.0000 0.0000 Select digit to flash.	6.7500 Select -9 thru 9 for flashing first digit, 0 thru 9 for other flashing digits (decimal point is set by dEC.Pt), then press ↩ Menu key.

Option board dependent menu items
ALSEt ALS34 dEU1H dEU2H dEU1b dEU2b dEU3H DEU4H DEU3b DEU4b Menu items related to alarm setup . These will only appear if a relay board is detected. If so, see Section 16.
AnSEt An Lo An Hi Menu items related to analog output setup . These will only appear if an analog output board is detected. If so, see Section 17.
SEr 1 SEr 2 SEr 3 SEr 4 Addr Menu items related to communications . These will only appear if an RS232, RS485, USB or Ethernet board is detected. If so, see Section 18.
Menu lockout items
Loc 1 Loc 2 Loc 3 Menu items used to enable or lock out (hide) other menu items . Loc menu items may in turn be locked out by a hardware jumper on the power supply board. See Section 9.

How to Maximize Accuracy of Load Cell Measurements

1. Avoid plated connectors or terminal blocks, since dissimilar metals can set up thermo-electric voltages in the millivolt range. If possible, use copper wiring throughout. If you have to use a junction box, have copper wire touch copper wire.
2. With long cable runs, use six-wire hookup, where the extra two wires are used to sense the excitation voltage at the load cell. This allows ratiometric meter operation to correct for voltage drops in the excitation wires.
3. Use twisted, shielded wire from the meter to the load cell to minimize pickup of electrical noise. Connect the shield to signal input ground at the meter. Do not connect the other end of the shield.
4. Do not run low-level signals in the same cable tray as electrical power to minimize pickup of electrical noise carried by power lines.
5. If pickup electrical noise is unavoidable, use the digital filtering capability of our meter to apply a time constant that averages out random noise over time.
6. Use 5V excitation, not 10V excitation, with miniature or button-type load cells. Even though small 350-ohm bridge load cells may be rated for 10V, the higher voltage will produce four times as much self-heating and will cause thermal errors.
7. Operate load cells within their linear range. Do not exceed specified maximum operating limits so as not to damage the load cell.
8. Operate load cell along their principal axis. Do not apply lateral or twisting forces, as these will cause deformation and produce non-intended electrical signals.

13. AC TRUE RMS VOLTS & AMPS INPUT

AC voltage or current measurement utilizes the True RMS signal conditioner board which uses precision circuitry to compute the root-mean-square of complex waveforms from 10 Hz to 10 kHz. Accurate measurements are obtained with spikes up to 3 times the maximum of each range. The input can be AC coupled to read only the AC component, such as ripple on a power supply, or DC coupled to read AC plus DC. The board needs to be configured via jumpers for the desired voltage or current range, and for AC or DC coupling. All signal ranges are factory calibrated with calibration factors stored in EEPROM. The meter software recognizes the board and will bring up the appropriate menu items for it; but it does not recognize the jumper settings. These need to be set manually. Please see further manual sections for [relay output](#), [analog output](#), [communications](#), and [transducer excitation output](#).

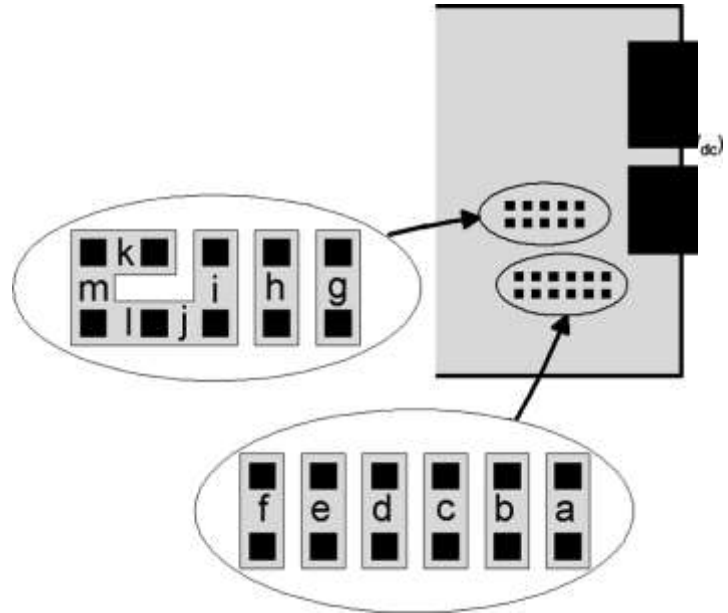

Voltage Ranges

Full Scale Input	Counts	Jumpers
200.00 mV	20000	j
2.0000 V	20000	c, g, h
20.000 V	20000	c, i
200.00 V	20000	c, k
300.0 V (ETL)	3000	c, m
600V (not ETL)	6000	c, m

Current Ranges

Full Scale Input	Counts	Jumpers
2.0000 mA	20000	l, k
20.000 mA	20000	b, m
200.00 mA	20000	a, m
5.000 A	5000	c, d, e, m

AC or DC Coupling

Coupling Type	Jumpers
DC coupling for AC + DC	f
AC coupling for AC only	none

RANGE SELECTION VIA JUMPERS

- Letters indicate jumper position. Jumpers are installed on pins adjacent to letters.
- Use 2.5 mm (0.1") jumpers.
- Store spare jumpers on unused jumper post.

SIGNAL CONNECTIONS

The RMS signal is applied to the signal conditioner board at P5, which is on the right when the meter is viewed from the back.

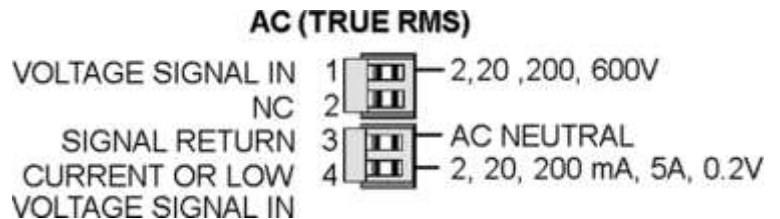

METER SCALING

Refer to the above tables for the full scale counts (or displayed digits) produced by the available full scale input ranges with a scale factor of 1 and an offset of 0. The decimal point can be set for direct readout in (milli)volts or (milli)amperes. Decimal point selection does not affect the counts. For example, a 20V input may be displayed as 20.000V or 20000 mV.

The 5A range, designed for use with a 5A current transformer (CT), is scaled to produce 5000 counts with a scale factor of 1 and an offset of 0. Use with a specific CT will require the scale factor to be set. For example, for an 800A input, 5A output CT, set a scale factor of 1.6. This is the desired 8000 count display at 5A divided by the default 5000 count display at 5A. Then set the decimal point to display to 800.0 at 5A.

All scaling methods applicable to DC, process, strain and load cell meters are available with AC RMS meters.

INTERNAL SHIELD

To reduce noise pickup inside the meter or transmitter, the RMS board is fitted with a flexible plug-on shield. If necessary, This shield may be removed for jumper setting, but must be reinstalled before closing the instrument.



SIGNAL SHIELDING

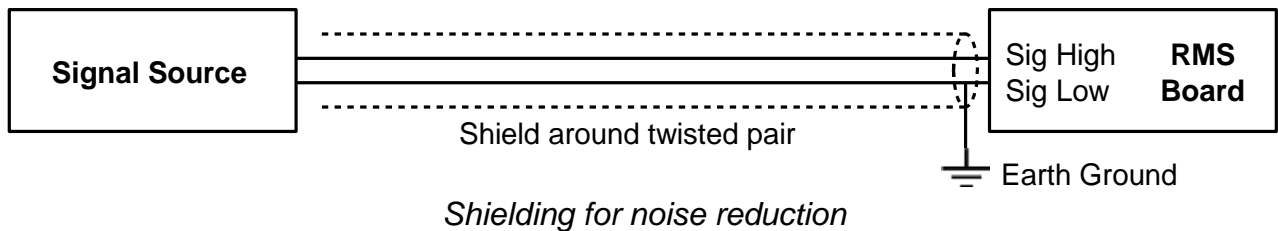

AC RMS measurements are susceptible to signal noise. This is especially true when the instrument has a wide bandwidth. To minimize noise pickup, the input signal wiring should utilize a shielded twisted pair, and the shield should be connected to signal low at the meter, as illustrated. If signal low is close to earth ground, such as within 2V, signal low can further be connected to earth ground at the meter, as illustrated.



PROVISION FOR SIGNAL LEVELS CLOSE TO ZERO



It is difficult to obtain meaningful RMS readings of 0 or close to 0 because of electrical noise pickup. To avoid erroneous very low readings, the RMS board has been programmed to return 0 counts for readings less than **15 counts**.



The maximum number of counts is 20000 for the 200.00 mV, 2.0000V, 20.000V, 200.00V, 2.0000 mA, 20.000 mA, and 200.00 mA ranges. The maximum number is 6000 for the 600.0V range (which is the 2000.0V range for counts purposes), so that 1 count is 0.1V. The maximum number is 5000 for the 5.000A range (which is the 20.000A for counts purposes), so that 1 count is 1 mA. If needed, the 15-count limit can be changed using the Custom ASCII protocol.

KEYSTROKES FOR SETUP

If the **MENU**  key does not work, see Section 9 “Enabling & Locking Out Menu Items.”

 MENU Press Menu Select Key	 PEAK Press Digit Select Key	 RESET Press Value Select Key
InPut Selection of signal input type & range. Needs to reflect jumper settings.	AC U AC Volts	0.2U 2.0U 20.0U 200.0U 600.0U 0.2, 2, 20, 200, 600V FS
	AC A AC Amps	2.0a 20.0a 200.0a 5.0A 2, 20, 200 mA, 5A FS
SEtUP Meter Setup	00_00 Display selection with scale factor of 1	0 4-1/2 digits ($\pm 20,000$) 1 5-digit remote display ($\pm 99,999$) 2 4-1/2 digits, counts by 10 ($\pm 20,000$) 3 3-1/2 digits ($\pm 2,000$)
	00_00 Power line frequency	0 Noise minimized for 60 Hz 1 Noise minimized for 50 Hz
	00_00 Scaling method	0 Scale and offset method 1 Coordinates of 2 points method 2 Reading coordinates of 2 points method
	00_00 Rear panel control inputs 1 & 2. Connections True = logic 1 (0V or tied to digital ground) False = logic 0 (5V or open)	0 1 = Reset, 2 = Meter Hold 1 1 = Function Reset 2 = Pk or Valley Disp. 2 1 = Meter Hold 2 = Pk or Valley Disp. 3 1 = Meter Hold 2 = Tare 4 1 = Peak or Valley 2 = Tare 5 1 = Tare 2 = Reset 6 1 = 0, 2 = 0, decimal point 1 = XXXXX 1 = 1, 2 = 0, decimal point 1 = XXXX.X 1 = 0, 2 = 1, decimal point 1 = XXX.XX 1 = 1, 2 = 1, decimal point 1 = XX.XXX 7 1 = 0, 2 = 0, decimal point 2 = XXXX.X 1 = 1, 2 = 0, decimal point 2 = XXX.XX 1 = 0, 2 = 1, decimal point 2 = XX.XXX 1 = 1, 2 = 1, decimal point 2 = X.XXXX 8 1 = Function Reset 2 = Display Blank 9 1 = Hold 2 = Display Blank A 1 = Peak or Valley 2 = Display Blank B 1 = Tare 2 = Display Blank C 1 = Valley Display 2 = Peak Display D 1 = Tare 2 = Tare Reset
Both inputs 1 and 2 set to 1 for selections 2, 4, A, C = Function Reset (fast, 20 msec). Both inputs 1 and 2 set to 1 for selections 0, 1, 3, 5, 8, 9, B, D = Meter Reset (slow, 2 sec, same as removing & reapplying power).		

 Press Menu Select Key	 Press Digit Select Key	 Press Value Select Key
ConFG Meter Configuration	000_0 Operation as a rate of change meter. <i>Extended meter only.</i>	0 Not rate of change 1 Rate x 0.1 2 Rate x 1 3 Rate x 10 4 Rate x 100 5 Rate x 1000 6 Rate x 10000
	00__0 Operation of front panel PEAK button and rear connector for Peak or Valley Display	0 Peak Display. Also selects “Peak” in “Peak or Valley” at connector above. 1 Valley Display. Also selects “Valley” in “Peak or Valley” at connector above. 2 Peak (1st push), Valley (2nd push) 3 Front panel Tare
	000_0 Auto-tare	0 Meter comes up in normal run mode. 1 Meter comes up in auto-tare mode.
	000_0 <i>Extended meter only.</i>	0 Linear input 1 Custom curve linearization
FiLtr Filtering	00000 Alarm filtering	0 Unfiltered output 1 Filtered output
	00000 Peak & Valley filtering	0 Unfiltered Peak & Valley 1 Filtered Peak & Valley
	00000 Display filtering	0 Display 16-reading batch average every 17 readings. Updates display 3.5 times/sec at 60 Hz, 3.0 times/sec at 50 Hz. 1 Display per input signal filter setting below
	00000 Adaptive filter threshold	0 Low adaptive filter threshold level 1 High adaptive filter threshold level
	00000 Input signal filter setting <i>Can be applied to display, setpoint, analog output, data output.</i>	0 Autofilter. Time constant set by meter. 1 Batch average of 16 readings 2 Moving average, 0.08 sec time constant. 3 Moving average, 0.15 sec time constant 4 Moving average, 0.3 sec time constant. 5 Moving average, 0.6 sec time constant. 6 Moving average, 1.2 sec time constant. 7 Moving average, 2.4 sec time constant. 8 Moving average, 4.8 sec time constant. 9 Moving average, 9.6 sec time constant. A Unfiltered. Readings updated at 60/sec at 60 Hz, 50/sec at 50 Hz.
dEc.Pt Decimal point selection	d_ddd Decimal point flashes.	d_ddd dd_ddd ddd_dd dddd_d ddddd_ _dddd

 MENU Press Menu Select Key	 PEAK Press Digit Select Key	 RESET Press Value Select Key
Scaling method "Scale and Offset" if selected under SEtuP		
SCALE Scale factor	0.0000 0.0000 0.0000 0.0000 0.0000 0.0000 Select digit then dec pt	Select 9 thru 9 for first flashing digit, 0 thru 9 for flashing other digits. Then press ▲ key to move flashing decimal point.
OFFst Offset value	0.0000 0.0000 0.0000 0.0000 0.0000 Select digit to flash.	Select 9 thru 9 for flashing first digit, 0 thru 9 for other flashing digits. Decimal point location is selected by dEC.Pt.
Scaling method "Coordinates of 2 points" if selected under SEtuP		
Lo In Low signal input.	0.0000 0.0000 0.0000 0.0000 0.0000 Select digit to flash.	Select 9 thru 9 for flashing first digit, 0 thru 9 for other flashing digits. Decimal point is set by input range chosen.
Lo rd Desired reading at Lo In.	0.0000 0.0000 0.0000 0.0000 0.0000 Select digit to flash.	Select 9 thru 9 for flashing first digit, 0 thru 9 for other flashing digits. Decimal point is set by dEC.Pt.
Hi In High signal input.	0.0000 0.0000 0.0000 0.0000 0.0000 Select digit to flash.	Select 9 thru 9 for flashing first digit, 0 thru 9 for other flashing digits. Decimal point is set by input range chosen.
Hi rd Desired reading at Hi In.	0.0000 0.0000 0.0000 0.0000 0.0000 Select digit to flash.	Select 9 thru 9 for flashing first digit, 0 thru 9 for other flashing digits. Decimal point is set by dEC.Pt.
Scaling method "Reading coordinates of 2 points" if selected under SEtuP . When this method is selected, the four menu items below will appear ahead of all other menu items when the MENU or ↩ key is first pressed from the run mode. See next page.		
Lo In Low signal input. Press ▶ key.	0.021 Apply low reference signal to meter.	0.021 Press ▲ key to store low signal input in meter, then press ↩ Menu key.
Hi In High signal input. Press ▶ key.	20.094 Apply high reference signal to meter.	0.021 Press ▲ to store high signal input meter, then press ↩ Menu key.
Lo rd Desired reading at Lo In. Press ▶ key.	0.0000 0.0000 0.0000 0.0000 0.0000 Modify flashing digit.	0.0000 Select 9 thru 9 for flashing first digit, 0 thru 9 for other flashing digits (decimal point is set by dEC.Pt.), then press ↩ Menu key.
Hi rd Desired reading at Hi In. Press ▶ key.	0.0000 0.0000 0.0000 0.0000 0.0000 Select digit to flash.	6.7500 Select 9 thru 9 for flashing first digit, 0 thru 9 for other flashing digits (decimal point is set by dEC.Pt.), then press ↩ Menu key.

Reading Coordinates of 2 Points Scaling Method

This scaling method applies a straight line fit between two points, which are determined from actual transducer signals and the desired corresponding meter readings. A low input signal, such as the output of a pressure transducer at zero pressure, and high input signal, such as the output of the same transducer at a known high pressure, are applied to the meter. The desired corresponding low reading and high reading are then entered from the front panel. The meter then applies straight line fit between the high and low calibration points. This scaling method has the advantage of calibrating the transducer and meter as a system. The actual voltages or currents the two points do not need to be known. This method is used with DC, process and load cell meters when known inputs are available. It is also available for AC meters. It is not available with thermocouple or RTD meters.

Option board dependent menu items
ALSEt ALS34 dEU1H dEU2H dEU1b dEU2b dEU3H DEU4H DEU3b DEU4b Menu items related to alarm setup . These will only appear if a relay board is detected. If so, see Section 16.
AnSEt An Lo An Hi Menu items related to analog output setup . These will only appear if an analog output board is detected. If so, see Section 17.
SER 1 SER 2 SER 3 SER 4 Addr Menu items related to communications . These will only appear if an RS232, RS485, USB or Ethernet board is detected. If so, see Section 18.
Menu lockout items
Loc 1 Loc 2 Loc 3 Menu items used to enable or lock out (hide) other menu items . Loc menu items may in turn be locked out by a hardware jumper. Please see Section 9.

14. THERMOCOUPLE INPUT

The thermocouple signal conditioner board used for temperature measurement can be configured via jumpers for either type J, K, E, N thermocouples or type T, R, S thermocouples, and for upscale or downscale open sensor indication. The meter software recognizes the thermocouple board and will bring up the appropriate menu items for it; however, it does not recognize jumper settings.

For each jumper selection, the thermocouple type, display in °C or °F, and resolution of 1°, 0.1° or 0.01° are user program selectable. High resolution should only be used for relative readings, not absolute readings. Although available, 0.01° resolution is not recommended for thermocouples. Offset adjustment is available for thermocouples and is normally set to 0000.0. If °C is selected, entering an offset of 0273.2 will change the display to Kelvin. If °F is selected, entering an offset of 0459.7 will change the display to Rankin.

The addition of a relay output board turns the thermocouple meter from a temperature indicator into an on/off temperature controller. Please see further manual sections for [relay output](#), [analog output](#), [communications](#), and [transducer excitation output](#).

BOARD SETUP VIA JUMPERS

Type	E4 Jumper
J, K, E, N, T, R, S	none j
Open Indication	E3 Jumper
Upscale Downscale	h i

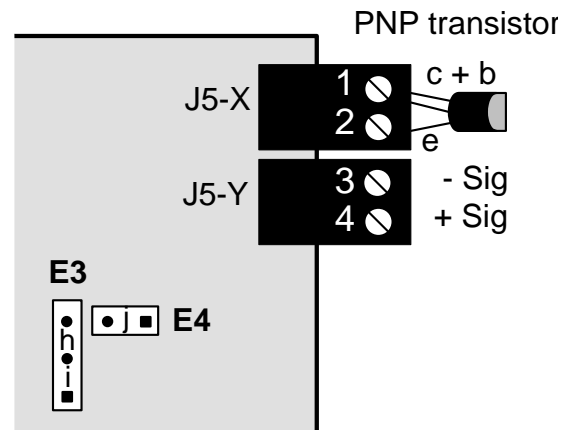

1. Jumpers are installed on pins bridging letters.
2. Use 2.5 mm (0.1") jumpers.
3. Store spare jumpers on an unused jumper post.

THERMOCOUPLE READING ERRORS

The following types of thermocouple errors need to be combined:

1. **Conformity error.** The difference between the meter reading and the temperature stated in NIST Monograph 125 (IPTS-68) for a specified thermocouple type, the thermoelectric voltage in mV, and a cold junction reference temperature of 0°C. For our meters, this error is typically less than 0.2°C across the entire thermocouple range.
2. **Voltage measurement error at 25°C.** With our meters, this is less than 0.01% of full scale at a meter temperature of 25°C, and hence also less than 0.01% of the temperature reading. This error is negligible.
3. **Voltage measurement span tempco error.** With our meters, this error is less than ±0.003% of the voltage reading/°C as the temperature of the meter changes, and hence also less than ±0.003% of the temperature reading/°C. This error is negligible.

- 4. Cold junction compensation (CJC) errors.** Our meters do not use an actual cold junction in ice water as the thermoelectric reference, but they calculate an offset by measuring the voltage drop across the PN junction of a PNP transistor in close proximity to the junction of the thermocouple wires and the meter terminals. The voltage drop changes by $-2.2 \text{ mV}/^\circ\text{C}$. We specify the reference junction error as 0.5°C for an ambient temperature of 10°C to 40°C . The signal conditioner board and PNP transistor are calibrated as a system, so do not swap transistors. To minimize CJC errors, avoid air turbulence around the PNP transistor.
- 5. Thermocouple wire errors.** This the largest source of thermocouple reading errors, and is caused by variations in the alloys found in commercial thermocouple wires. There are variations from manufacturer to manufacturer, from batch to batch, and within batches. Shown below are the American Limits of Error ASTM E230-ANSI MC 96.1. These are the error limits imposed on manufacturers of thermocouple wire, not error limits applicable to a meter used with ideal thermocouple wire. The “Special Limit of Error” applies to more expensive “Special Limits of Error” (SLE) thermocouple wire.



Thermocouple Type	Temperature Range $^\circ\text{C}$	Temperature Range $^\circ\text{F}$	Standard Limit of Error	Special Limit of Error
J	0 to 750°C	32 to 1382°F	2.2°C or 0.75%	1.1°C or 0.4%
K	0 to 1250°C -200 to 0°C	32 to 2282°F -328 to 32°F	2.2°C or 0.75% 2.2°C or 2.0%	1.1°C or 0.4%
T	0 to 350°C -200 to 0°C	32 to 662°F -328 to 32°F	1.0°C or 0.75% 1.0°C or 1.5%	0.5°C or 0.4%
E	0 to 900°C -200 to 0°C	32 to 1652°F -328 to 32°F	1.7°C or 0.5% 1.7°C or 1.0%	1.0°C or 0.4%
N	0 to 1300°C -270 to 0°C	32 to 2372°F -454 to 32°F	2.2°C or 0.75% 2.2°C or 2.0%	1.1°C or 0.4%
S or R	0 to 1450°C	32 to 2642°F	1.5°C or 0.25%	0.6°C or 0.1%



The “Limit or Error” tolerance to be used is the listed temperature or percentage, whichever is greater. Tolerances expressed in $^\circ\text{F}$ are 1.8 times those in $^\circ\text{C}$. Percentage based tolerances are to be computed from temperatures expressed in $^\circ\text{C}$.

Tolerances in the above table apply to new, essentially homogeneous thermocouple wire, normally 0.25 to 33 mm in diameter (30 to 8 AWG) and used at temperatures not exceeding the upper temperature limits listed. If used at higher temperatures, these tolerances do not apply. Thermocouples degrade with time, temperature, and exposure to the environment.

KEYSTROKES FOR SETUP

If the **MENU**  key does not work, see Section 9 “Enabling & Locking Out Menu Items.”

 MENU Press Menu Select Key	 PEAK Press Digit Select Key	 RESET Press Value Select Key																											
InPut Selection of signal input type & range. Needs to go with jumper selection.	tC Thermocouple	<table border="0"> <tr> <td>J °F</td> <td>J °C</td> <td>Type J, °F or °C</td> </tr> <tr> <td>K °F</td> <td>K °C</td> <td>Type K, °F or °C</td> </tr> <tr> <td>n °F</td> <td>n °C</td> <td>Type N, °F or °C</td> </tr> <tr> <td>E °F</td> <td>E °C</td> <td>Type E, °F or °C</td> </tr> <tr> <td>t °F</td> <td>t °C</td> <td>Type T, °F or °C</td> </tr> <tr> <td>S °F</td> <td>S °C</td> <td>Type S, °F or °C</td> </tr> <tr> <td>r °F</td> <td>r °C</td> <td>Type R, °F or °C</td> </tr> </table>	J °F	J °C	Type J, °F or °C	K °F	K °C	Type K, °F or °C	n °F	n °C	Type N, °F or °C	E °F	E °C	Type E, °F or °C	t °F	t °C	Type T, °F or °C	S °F	S °C	Type S, °F or °C	r °F	r °C	Type R, °F or °C						
J °F	J °C	Type J, °F or °C																											
K °F	K °C	Type K, °F or °C																											
n °F	n °C	Type N, °F or °C																											
E °F	E °C	Type E, °F or °C																											
t °F	t °C	Type T, °F or °C																											
S °F	S °C	Type S, °F or °C																											
r °F	r °C	Type R, °F or °C																											
SEtUP Meter Setup	00_00 Display selection.	0 0.1 degree resolution 1 5-digit remote display (±99,999) 2 0.01 degree resolution 3 1 degree resolution																											
	00_00 Power line frequency	0 Noise minimized for 60 Hz 1 Noise minimized for 50 Hz																											
	00_00 Scaling method	0 Offset only for thermocouple input.																											
	00_00 Rear panel control inputs 1 & 2: True = logic 1 (0V or tied to digital ground) False = logic 0 (5V or open)	<table border="0"> <tr> <td>0</td> <td>1 = Reset, 2 = Meter Hold</td> </tr> <tr> <td>1</td> <td>1 = Function Reset, 2 = Peak or Valley</td> </tr> <tr> <td>2</td> <td>1 = Hold, 2 = Peak or Valley Display</td> </tr> <tr> <td>3</td> <td>1 = Hold, 2 = Tare</td> </tr> <tr> <td>4</td> <td>1 = Peak or Valley Display, 2 = Tare</td> </tr> <tr> <td>5</td> <td>1 = Tare, 2 = Reset</td> </tr> <tr> <td>6</td> <td>1 = 0, 2 = 0, decimal point 1 = XXXXX 1 = 1, 2 = 0, decimal point 1 = XXXX.X 1 = 0, 2 = 1, decimal point 1 = XXX.XX 1 = 1, 2 = 1, decimal point 1 = XX.XXX</td> </tr> <tr> <td>7</td> <td>1 = 0, 2 = 0, decimal point 2 = XXXX.X 1 = 1, 2 = 0, decimal point 2 = XXX.XX 1 = 0, 2 = 1, decimal point 2 = XX.XXX 1 = 1, 2 = 1, decimal point 2 = X.XXXX</td> </tr> <tr> <td>8</td> <td>1 = Function Reset 2 = Display Blank</td> </tr> <tr> <td>9</td> <td>1 = Hold 2 = Display Blank</td> </tr> <tr> <td>A</td> <td>1 = Peak or Valley 2 = Display Blank</td> </tr> <tr> <td>B</td> <td>1 = Tare 2 = Display Blank</td> </tr> <tr> <td>C</td> <td>1 = Valley Display 2 = Peak Display</td> </tr> <tr> <td>D</td> <td>1 = Tare 2 = Tare Reset</td> </tr> </table> <p>Both control inputs 1 & 2 set to 1 for selections 2, 4, A, C = Function Reset. Both control inputs 1 & 2 set to 1 for selections 0, 1, 3, 5, 8, 9, B, D = Meter Reset.</p>	0	1 = Reset, 2 = Meter Hold	1	1 = Function Reset, 2 = Peak or Valley	2	1 = Hold, 2 = Peak or Valley Display	3	1 = Hold, 2 = Tare	4	1 = Peak or Valley Display, 2 = Tare	5	1 = Tare, 2 = Reset	6	1 = 0, 2 = 0, decimal point 1 = XXXXX 1 = 1, 2 = 0, decimal point 1 = XXXX.X 1 = 0, 2 = 1, decimal point 1 = XXX.XX 1 = 1, 2 = 1, decimal point 1 = XX.XXX	7	1 = 0, 2 = 0, decimal point 2 = XXXX.X 1 = 1, 2 = 0, decimal point 2 = XXX.XX 1 = 0, 2 = 1, decimal point 2 = XX.XXX 1 = 1, 2 = 1, decimal point 2 = X.XXXX	8	1 = Function Reset 2 = Display Blank	9	1 = Hold 2 = Display Blank	A	1 = Peak or Valley 2 = Display Blank	B	1 = Tare 2 = Display Blank	C	1 = Valley Display 2 = Peak Display	D
0	1 = Reset, 2 = Meter Hold																												
1	1 = Function Reset, 2 = Peak or Valley																												
2	1 = Hold, 2 = Peak or Valley Display																												
3	1 = Hold, 2 = Tare																												
4	1 = Peak or Valley Display, 2 = Tare																												
5	1 = Tare, 2 = Reset																												
6	1 = 0, 2 = 0, decimal point 1 = XXXXX 1 = 1, 2 = 0, decimal point 1 = XXXX.X 1 = 0, 2 = 1, decimal point 1 = XXX.XX 1 = 1, 2 = 1, decimal point 1 = XX.XXX																												
7	1 = 0, 2 = 0, decimal point 2 = XXXX.X 1 = 1, 2 = 0, decimal point 2 = XXX.XX 1 = 0, 2 = 1, decimal point 2 = XX.XXX 1 = 1, 2 = 1, decimal point 2 = X.XXXX																												
8	1 = Function Reset 2 = Display Blank																												
9	1 = Hold 2 = Display Blank																												
A	1 = Peak or Valley 2 = Display Blank																												
B	1 = Tare 2 = Display Blank																												
C	1 = Valley Display 2 = Peak Display																												
D	1 = Tare 2 = Tare Reset																												

 Press Menu Select Key	 Press Digit Select Key	 Press Value Select Key
ConFG Meter Configuration	000_0	0 No used.
	00__0 Operation of front panel <i>PEAK</i> button and rear connector for Peak or Valley Display	0 Peak Display. Also selects “Peak” in “Peak or Valley” at rear connector. 1 Valley Display. Also selects “Valley” in “Peak or Valley” at rear connector. 2 Peak (1st push), Valley (2nd push) 3 Front panel Tare
FilTr Filtering	00000 Alarm filtering	0 Unfiltered output 1 Filtered output
	00000 Peak & Valley filtering	0 Unfiltered Peak & Valley 1 Filtered Peak & Valley
	00000 Display filtering	0 Display batch average of every 16 readings. 3.5 updates at 60 Hz, 3.0 at 50 Hz. 1 Display per input signal filter setting below
	00000 Adaptive filter threshold for all filters	0 Low adaptive filter threshold level 1 High adaptive filter threshold level
	00000 Input signal filter setting <i>Can be applied to display, setpoint, analog output, data output.</i>	0 Autofilter. Time constant set by meter. 1 Batch average of 16 readings 2 Moving average, 0.08 sec time constant. 3 Moving average, 0.15 sec time constant. 4 Moving average, 0.3 sec time constant. 5 Moving average, 0.6 sec time constant. 6 Moving average, 1.2 sec time constant. 7 Moving average, 2.4 sec time constant. 8 Moving average, 4.8 sec time constant. 9 Moving average, 9.6 sec. A Unfiltered
OFFst Offset value	0.0000 0.0000 0.0000 0.0000 0.0000 Select digit to flash.	Select -9 thru 9 for flashing first digit, 0 thru 9 for other flashing digits. Use offset for display in Rankine or Kelvin.
Option board dependent menu items		
ALSEt ALS34 dEU1H dEU2H dEU1b dEU2b dEU3H DEU4H DEU3b DEU4b Menu items related to alarm setup if a relay board is detected. Please see Section 16.		
AnSEt An Lo An Hi Menu items related to analog output if detected. Please see Section 17.		
SEr 1 SEr 2 SEr 3 SEr 4 Addr Menu items related to communications if detected. Please see Section 18.		
Menu lockout items		
Loc 1 Loc 2 Loc 3 Menu items used to enable or lock out (hide) menu items . Please see Section 9.		

15. RTD & RESISTANCE INPUT

The standard RTD and resistance signal conditioner board are jumper selectable for four RTD types (DIN 100Ω platinum, ANSI 100Ω platinum, 120Ω nickel, 10Ω copper) and five resistance ranges (from 20.000Ω to 200.00 kΩ). Fixed 2Ω, 2 MΩ or 20 MΩ resistance ranges require a factory modified signal conditioner board where other ranges are no longer jumper selectable.

All ranges are factory calibrated with calibration factors stored in EEPROM on the signal conditioner board. The meter software recognizes the board and will bring up the appropriate menu items for it; however, it does not recognize the jumper settings. With RTDs, display in °C or °F and resolution of 1°, 0.1° or 0.01° are user programmable.

SIGNAL CONDITIONER BOARD SETUP VIA JUMPERS

Jumper selectable ranges	Factory modified fixed ranges	E1 Jumper
Pt100, Ni120	N/A	a
Cu10, 20.000Ω (R1)	0-2.0000 Ω (R0)	b
0-200.00Ω (R2)	N/A	c
0-2.0000 kΩ (R3)	N/A	d
0-20.000 kΩ (R4)	N/A	e
0-200.00 kΩ (R5)	0-2.0000 MΩ (R6)	f
	0-20.000 MΩ (R7)	f
Connection		E2 Jumper
2 or 4 wire		none
3 wire		g

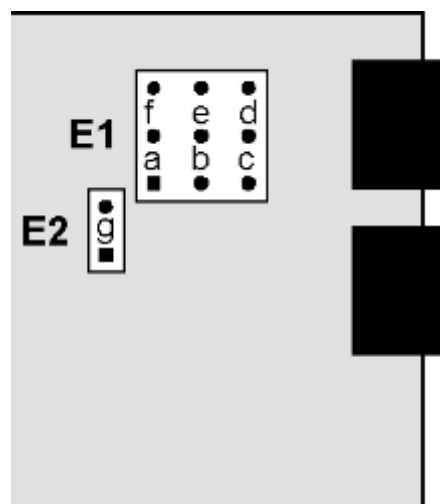

1. Jumpers are installed on pins bridging letters.
2. Use 2.5 mm (0.1") jumpers.
3. Store unused jumpers on one pin so that one side is not connected.

SCALE & OFFSET SETUP

Scale is normally set to 1.0000. Scale can be used as an RTD resistance multiplier when the actual resistance is other than nominal at 0°C. For example, if the resistance of a Pt100 RTD is measured as 99.04 ohms at 0°C, you can apply a scale factor of $100 / 99.04 = 1.0097$.

Offset allow the reading in degrees or ohms to be increased or decreased by a fixed amount.

SIGNAL SHIELDING

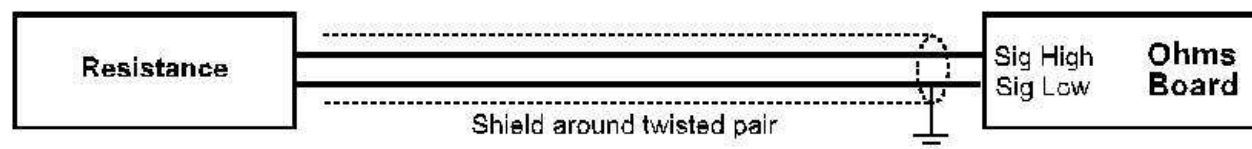

Shielding for noise reduction

Ranges of 200 kΩ and above are susceptible to signal noise. To minimize noise pickup, the input signal wiring should utilize a shielded twisted pair, and the shield should be connected to signal low and earth ground at the meter, as illustrated.

RTD & RESISTANCE CONNECTION

With the appropriate jumper settings, RTD and resistance measurements allow 2, 3 or 4-wire RTD hookup to the J5 connector, as illustrated. The meter applies a fixed excitation current.

In 4-wire hookup, the excitation and sense wires are joined at the load. Resistance of the excitation leads is not a factor, since excitation is a constant current. Resistance of the sense leads is not a factor, since voltage sensing is at high impedance. 4-wire hookup is recommended for long RTD cable runs and for the R0 0-2 ohm and R1 0-20 ohm ranges.

In 3-wire hookup, the meter automatically compensates for lead resistance by measuring the voltage drop on only one current-carrying excitation lead and multiplying that drop by 2. Jumper **g** needs to be installed at E2. The two leads need to have the same resistance.

In 2-wire hookup, the excitation and sensing wires are joined at the meter to simplify wiring to the load. Setup software described below can measure the resistance of the lead wires when these are shorted at the load, and the meter then automatically subtracts wire resistance from the resistance measurement. The short should be as close as possible to the load. Ambient temperature changes will still cause some error in the readings -- the higher the lead resistance, the greater the error. OK to use 2-wire hookup without the special setup software steps below if wire resistance is negligible compared to the resistance to be measured.

To eliminate lead wire resistance with 2-wire hookup, follow this procedure:



1. Set the InPut menu item and jumpers for the desired range.
2. Set SEtuP to **00_01** to set Control Input 2 (Pin P1-4 on page 6) to "Peak or Valley."
3. Set ConFG to **00011** (2-wire short).
4. Short the two leads at the sensor end to create a 2-wire short.
5. With the leads shorted at the sensor end, momentarily short Control Input 2 to Control Input Return (Pin P1-4 to Pin P1-6 on page 6). This will store a value proportional to lead resistance, automatically change CONFG to **00010** (2-wire read), and Reset the meter.
6. Remove the short and connect the sensor. The meter will now display sensor resistance less wire resistance. You can now also change SEtuP.

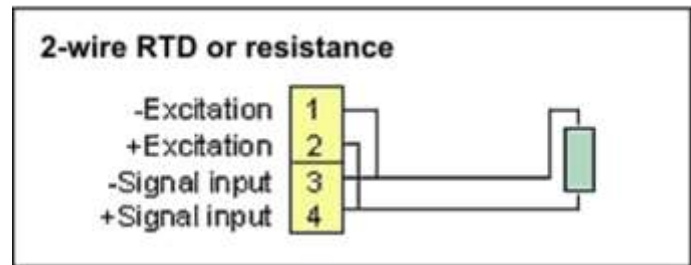
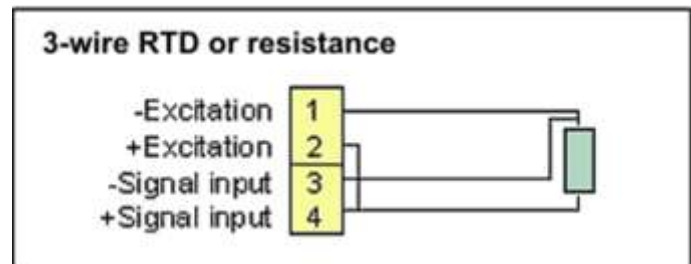
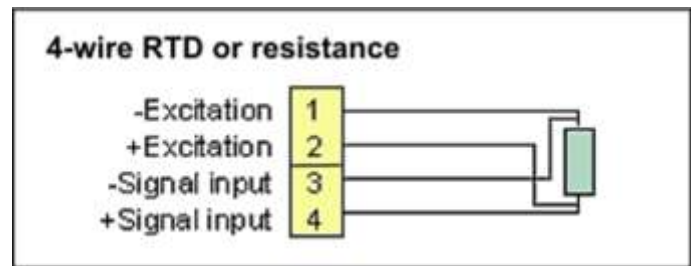

If the range and associated jumpers are subsequently changed, the above procedure must be repeated. This procedure is also available through Instrument Setup software.





KEYSTROKES FOR SETUP

If the **MENU**  key does not work, see Section 9 “Enabling & Locking Out Menu Items.”

 Press Menu Select Key	 Press Digit Select Key	 Press Value Select Key
InPut Selection of signal input type & range. Need to reflect jumper setting.	rtd RTD	d °F Pt100 RTD, DIN alpha .00385, °F d °C Pt100 RTD, DIN alpha .00385, °C A °F Pt100 RTD, ANSI alpha .003902, °F A °C Pt100 RTD, ANSI alpha .003902, °C ni °F Ni120 RTD, alpha .00672, °F ni °C Ni120 RTD, alpha .00672, °C Cu °F Cu10 RTD, alpha .00427, °F Cu °C Cu10 RTD, alpha .00427, °C
	OHnns Ohmmeter Set decimal point under dEc.Pt	20 0 to 20.000 ohms 200 0 to 200.00 ohms 2000 0 to 2000.0 ohms 20000 0 to 20000 ohms 200.00 0 to 200.00 kohm
SEtuP Meter Setup	00_00 Display selection with scale factor of 1.	0 0.1° RTD or 4-1/2 digits for ohms 1 5-digit remote display (±99,999) 2 0.01° RTD, 4-1/2 digit ohms count by 10 3 1° RTD or 3-1/2 digits for ohms
	00_00 Power line frequency	0 Noise minimized for 60 Hz 1 Noise minimized for 50 Hz
	00_00 Scaling method	0 Scale and offset method (RTD & ohms) 1 Coordinates of 2 points (ohms) 2 Reading coordinates of 2 points (ohms)
	00_00 Rear panel control inputs 1 & 2: True = logic 1 (0V or tied to digital ground) False = logic 0 (5V or open)	0 1 = Reset, 2 = Meter Hold 1 1 = Function Reset, 2 = Peak or Valley 2 1 = Hold, 2 = Peak or Valley Display 3 1 = Hold, 2 = Tare 4 1 = Peak or Valley Display, 2 = Tare 5 1 = Tare, 2 = Reset 6 1 = 0, 2 = 0, decimal point 1 = XXXXX 1 = 1, 2 = 0, decimal point 1 = XXXX.X 1 = 0, 2 = 1, decimal point 1 = XXX.XX 1 = 1, 2 = 1, decimal point 1 = XX.XXX 7 1 = 0, 2 = 0, decimal point 2 = XXXX.X 1 = 1, 2 = 0, decimal point 2 = XXX.XX 1 = 0, 2 = 1, decimal point 2 = XX.XXX 1 = 1, 2 = 1, decimal point 2 = X.XXXX

 Press Menu Select Key	 Press Digit Select Key	 Press Value Select Key														
SEtUP Meter Setup (continued)	00_00 Control inputs 1 & 2 (continued)	8 1 = Function Reset 2 = Display Blank 9 1 = Hold 2 = Display Blank A 1 = Peak or Valley 2 = Display Blank B 1 = Tare 2 = Display Blank C 1 = Valley Display 2 = Peak Display D 1 = Tare 2 = Tare Reset Both inputs 1 and 2 set to 1 for selections 2, 4, A, C = Function Reset (fast, 20 msec). Both inputs 1 and 2 set to 1 for selections 0, 1, 3, 5, 8, 9, B, D = Meter Reset (slow, 2 sec, same as removing & reapplying power).														
ConFG Meter Configuration	00000 Operation as a rate of change meter. Extended meter only.	0 Not rate of change 3 Rate x 10 1 Rate x 0.1 5 Rate x 1000 2 Rate x 1 6 Rate x 10000														
	00000 Operation of front panel <i>PEAK</i> button and rear connector for Peak or Valley Display	0 Peak Display. Also selects "Peak" in "Peak or Valley" at connector above. 1 Valley Display. Also selects "Valley" in "Peak or Valley" at connector above. 2 Peak (1st push), Valley (2nd push) 3 Front panel Tare														
	00000 Auto-tare selection	0 No auto-tare 1 Auto-tare														
	00000 RTD or Ohms wiring	<table border="0"> <tr> <td></td> <td>RTD</td> <td>Ohms</td> </tr> <tr> <td>00</td> <td>3 or 4 wire</td> <td>3 or 4 wire</td> </tr> <tr> <td>01</td> <td>Not allowed</td> <td>Custom curve</td> </tr> <tr> <td>10</td> <td>2-wire read</td> <td>2-wire read</td> </tr> <tr> <td>11</td> <td>2-wire short</td> <td>2-wire short</td> </tr> </table>		RTD	Ohms	00	3 or 4 wire	3 or 4 wire	01	Not allowed	Custom curve	10	2-wire read	2-wire read	11	2-wire short
	RTD	Ohms														
00	3 or 4 wire	3 or 4 wire														
01	Not allowed	Custom curve														
10	2-wire read	2-wire read														
11	2-wire short	2-wire short														
FiLtr Filtering	00000 Alarm filtering	0 Unfiltered output 1 Filtered output														
	00000 Peak & Valley filtering	0 Unfiltered Peak & Valley 1 Filtered Peak & Valley														
	00000 Display filtering	0 Display 16-reading batch average every 17 readings. Updates display 3.5 times/sec at 60 Hz, 3.0 times/sec at 50 Hz. 1 Display per input signal filter setting below														
	00000 Adaptive filter threshold for all filters	0 Low adaptive filter threshold level 1 High adaptive filter threshold level														

 Press Menu Select Key	 Press Digit Select Key	 Press Value Select Key
FiLtr Filtering (continued)	00000 Input signal filter setting <i>Can be applied to display, setpoint, analog output, data output.</i>	0 Autofilter 1 Batch average, 16 readings 2 Moving average, 0.08 sec. 3 Moving average, 0.15 sec. 4 Moving average, 0.3 sec. 5 Moving average, 0.6 sec. 6 Moving average, 1.2 sec. 7 Moving average, 2.4 sec. 8 Moving average, 4.8 sec. 9 Moving average, 9.6 sec. A Unfiltered. Updates at 60/sec at 60 Hz, 50/sec at 50 Hz.
dEc.Pt Decimal point selection	d_ddd Decimal point flashes if ohms are selected under InPut	d_ddd dd_ddd ddd_dd dddd_d dddd_d_ _ddd
SCALE Scale factor	0.0000 0.0000 0.0000 0.0000 0.0000 0.0000 Select digit then dec pt	Select -9 thru 9 for first flashing digit, 0 thru 9 for flashing other digits. Then press ▲ key to move flashing decimal point.
OFFst Offset value	0.0000 0.0000 0.0000 0.0000 0.0000 Select digit to flash.	Select -9 thru 9 for flashing first digit, 0 thru 9 for other flashing digits. Use offset for display in Rankine or Kelvin. Decimal point location is selected by dEC.Pt .
Option board dependent menu items		
ALSEt ALS34 dEU1H dEU2H dEU1b dEU2b dEU3H DEU4H DEU3b DEU4b Menu items related to alarm setup These will only appear if a relay board is detected. If so, see Section 16.		
AnSEt An Lo An Hi Menu items related to analog output setup . These will only appear if an analog output board is detected. If so, see Section 17.		
SEr 1 SEr 2 SEr 3 SEr 4 Addr Menu items related to communications . These will only appear if an RS232, RS485, USB or Ethernet board is detected. If so, see Section 18.		
Menu lockout items		
Loc 1 Loc 2 Loc 3 Menu items used to enable or lock out (hide) other menu items . Loc menu items may in turn be locked out by a hardware jumper on the power supply board. See Section 9.		

16. DUAL OR QUAD RELAY OUTPUT OPTION

An optional relay board may be installed in the meter main board at plug position P2, adjacent to the power supply board. Four board versions are available: 2 or 4 relays, mechanical or solid state. Once installed, the relay board is recognized by the meter software or PC-based Instrument Setup software, which will bring up the appropriate menu items for the type of board. These menu items will not be brought up if no relay board is detected. Menu selections for relays 3 and 4 will not be brought up if the dual relay board is detected. All relay boards offer a choice of operating modes: normally off or on, latched or non-latched, hysteresis band, deviation band, alarm based on the filtered or unfiltered signal, and selectable number of readings in alarm zone to cause an alarm.







KEYSTROKES FOR VIEWING & CHANGING SETPOINTS



The **←** (Alarms) key can be used to step through and view setpoints while the meter continues to make conversions and performs setpoint control. If the **▶** (Peak) key is pressed while a setpoint is displayed, conversion stops and the setpoint can be changed. After pressing **←**, you have 30 seconds, or the meter reverts to the normal display. To view setpoints, menu item Loc3, digit 2, must have been set to 0. To change setpoints, menu item Loc2, digit 2, must have been set to 0.

ALARMS ← <i>Press Alarms Key</i>	PEAK ▶ <i>Press Digit Select Key</i>	RESET ▲ <i>Press Value Select Key</i>
300.24 Press ← (Alarms) to display Alarm 1 setpoint.	200.00 Current setpoint 1 value blinks, and Alarm 1 LED indicator lights. Press ▶ to select a digit, which will blink.	295.00 To change setpoint 1 value, press ▲ to change selected blinking digits.
395.00 Press ← (Alarms) to display Alarm 2 setpoint.	395.00 Current setpoint 2 value blinks, and Alarm 2 LED indicator lights. Press ▶ to select a digit, which will blink.	305.00 To change setpoint 2 value, press ▲ to change selected blinking digits.
395.00 Press ← (Alarms) to display Alarm 3 setpoint.	395.00 Current setpoint 3 value blinks, and Alarm 3 LED indicator lights. Press ▶ to select a digit, which will blink.	305.00 To change setpoint 3 value, press ▲ to change selected blinking digits.
395.00 Press ← (Alarms) to display Alarm 4 setpoint.	395.00 Current setpoint 4 value blinks, and Alarm 4 LED indicator lights. Press ▶ to select a digit, which will blink.	305.00 To change setpoint 4 value, press ▲ to change selected blinking digits.
300.24 Press ← (Alarms) again. Meter will reset and display current reading.		

KEYSTROKES FOR SETPOINT SETUP

If the *MENU*  key does not work, see Section 9 “Enabling & Locking Out Menu Items.”

 MENU Press Menu Select Key	 PEAK Press Digit Select Key	 RESET Press Value Select Key
ALSEt Alarm Setup for relays 1 & 2 if detected. Press  until <i>ALSEt</i> is displayed.	00000 Relay open or closed when in alarm state.	0 AL1 relay closed AL2 relay closed 1 AL1 relay open AL2 relay closed 2 AL1 relay closed AL2 relay open 3 AL1 relay open AL2 relay open
	00000 Alarm latching or non-latching (auto reset). See Glossary.	0 AL1 non-latching AL2 non-latching 1 AL1 latching AL2 non-latching 2 AL1 non-latching AL2 latching 3 AL1 latching AL2 latching
	00000 Alarm state occurs at or above setpoint, or below setpoint, or is disabled. Front panel indicator lights come on in alarm state,	0 AL1 at or above AL2 at or above 1 AL1 below AL2 at or above 2 AL1 disabled AL2 at or above 3 AL1 at or above AL2 below 4 AL1 below AL2 below 5 AL1 disabled AL2 below 6 AL1 at or above AL2 disabled 7 AL1 below AL2 disabled 8 AL1 disabled AL2 disabled
	00000 Hysteresis mode or band deviation mode. See Glossary.	0 AL1 band deviation AL2 band deviation 1 AL1 split hysteresis AL2 band deviation 2 AL1 band deviation AL2 split hysteresis 3 AL1 split hysteresis AL2 split hysteresis 4 No deviation or hysteresis in menu. 5 AL1 span hysteresis AL2 band deviation 6 AL1 span hysteresis AL2 split hysteresis 7 AL1 span hysteresis AL2 span hysteresis
	00000 Number of consecutive readings in alarm zone to enter alarm state.	0 After 1 reading 4 After 16 readings 1 After 2 readings 5 After 32 readings 2 After 4 readings 6 After 64 readings 3 After 8 readings 7 After 128 reading
ALS34 Alarm Setup for relays 3 & 4 if detected.	00000 Relay open or closed when in alarm state.	0 AL3 relay closed AL4 relay closed 1 AL3 relay open AL4 relay closed 2 AL3 relay closed AL4 relay open 3 AL3 relay open AL4 relay open
	00000 Alarm latching or non-latching (auto reset).	0 AL3 non-latching AL4 non-latching 1 AL3 latching AL4 non-latching 2 AL3 non-latching AL4 latching 3 AL3 latching AL4 latching

 Press Menu Select Key	 Press Digit Select Key	 Press Value Select Key										
ALS34 Alarm Setup for relays 3 & 4 (continued)	00000 Alarm state occurs at or above setpoint, or below setpoint, or is disabled. Front panel indicator lights come on in alarm state,	0 AL3 at or above AL4 at or above 1 AL3 below AL4 at or above 2 AL3 disabled AL4 at or above 3 AL3 at or above AL4 below 4 AL3 below AL4 below 5 AL3 disabled AL4 below 6 AL3 at or above AL4 disabled 7 AL3 below AL4 disabled 8 AL3 disabled AL4 disabled										
	00000 Hysteresis mode or band deviation mode (see Glossary)	0 AL3 band deviation AL4 band deviation 1 AL3 split hysteresis AL4 band deviation 2 AL3 band deviation AL4 split hysteresis 3 AL3 split hysteresis AL4 split hysteresis										
	00000 Number of consecutive readings in alarm zone to enter alarm state.	0 After 1 reading 4 After 16 readings 1 After 2 readings 5 After 32 readings 2 After 4 readings 6 After 64 readings 3 After 8 readings 7 After 128 reading										
dEU1H Alarm 1 hysteresis	0.0000 0.0000 0.0000 0.0000 0.0000 Select digit to flash.	Select -9 thru 9 for flashing first digit, 0 thru 9 for other flashing digits. Alarms will activate above the setpoint by the value entered and deactivate below the setpoint by the value entered.										
DEU2H Alarm 2 hysteresis			DEU1b Alarm 1 band deviation	0.0000 0.0000 0.0000 0.0000 0.0000 Select digit to flash.	Select -9 thru 9 for flashing first digit, 0 thru 9 for other flashing digits. Alarms will activate above and below the setpoint by the value entered and will deactivate in the middle of the band.	DEU2b Alarm 2 band deviation	dEU3H Alarm 3 hysteresis	0.0000 0.0000 0.0000 0.0000 0.0000 Select digit to flash.	Select -9 thru 9 for flashing first digit, 0 thru 9 for other flashing digits. Alarms will activate above the setpoint by the value entered and deactivate below the setpoint by the value entered.	DEU4H Alarm 4 hysteresis	DEU3b Alarm 3 band deviation	0.0000 0.0000 0.0000 0.0000 0.0000 Select digit to flash.
DEU1b Alarm 1 band deviation	0.0000 0.0000 0.0000 0.0000 0.0000 Select digit to flash.	Select -9 thru 9 for flashing first digit, 0 thru 9 for other flashing digits. Alarms will activate above and below the setpoint by the value entered and will deactivate in the middle of the band.										
DEU2b Alarm 2 band deviation			dEU3H Alarm 3 hysteresis	0.0000 0.0000 0.0000 0.0000 0.0000 Select digit to flash.	Select -9 thru 9 for flashing first digit, 0 thru 9 for other flashing digits. Alarms will activate above the setpoint by the value entered and deactivate below the setpoint by the value entered.	DEU4H Alarm 4 hysteresis	DEU3b Alarm 3 band deviation	0.0000 0.0000 0.0000 0.0000 0.0000 Select digit to flash.	Select -9 thru 9 for flashing first digit, 0 thru 9 for other flashing digits. Alarms will activate above and below the setpoint by the value entered and will deactivate in the middle of the band.	DEU4b Alarm 4 band deviation		
dEU3H Alarm 3 hysteresis	0.0000 0.0000 0.0000 0.0000 0.0000 Select digit to flash.	Select -9 thru 9 for flashing first digit, 0 thru 9 for other flashing digits. Alarms will activate above the setpoint by the value entered and deactivate below the setpoint by the value entered.										
DEU4H Alarm 4 hysteresis			DEU3b Alarm 3 band deviation	0.0000 0.0000 0.0000 0.0000 0.0000 Select digit to flash.	Select -9 thru 9 for flashing first digit, 0 thru 9 for other flashing digits. Alarms will activate above and below the setpoint by the value entered and will deactivate in the middle of the band.	DEU4b Alarm 4 band deviation						
DEU3b Alarm 3 band deviation	0.0000 0.0000 0.0000 0.0000 0.0000 Select digit to flash.	Select -9 thru 9 for flashing first digit, 0 thru 9 for other flashing digits. Alarms will activate above and below the setpoint by the value entered and will deactivate in the middle of the band.										
DEU4b Alarm 4 band deviation												

17. ANALOG OUTPUT OPTION

An optional analog output board may be installed in the meter at rear panel jack position J4, adjacent to the signal conditioner board. Once installed, this board is recognized by the meter, which will bring up the appropriate menu items for it. These will not be brought up if an analog output board is not installed.

The analog output can be a 0-20 mA, 4-20 mA or 0-10V unipolar signal with respect to isolated ground, or a bipolar -10V to +10V voltage signal with respect to a reference return line. Unipolar or bipolar operation is selected by a jumper. A unipolar current or voltage output is selected at the connector. Unipolar 4-20 mA or 0-20 mA current is selected in software.

Unipolar current or voltage:
Jumper **a**

Bipolar -10 to +10 voltage:
Jumper **b**

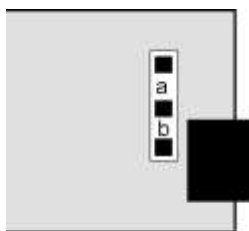

UNIPOLAR CONNECTIONS

4-20 mA or 0-20 mA OUTPUT 1
0-10V OUTPUT 2
ISOLATED GROUND 3

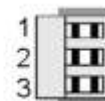

BIPOLAR CONNECTIONS

REFERENCE or RETURN 1
-10V to +10V OUTPUT 2
N/C 3

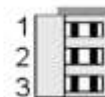

The analog output is sourcing. Do not put an external voltage source in series with it. Applying an external 24 Vdc source will burn out the analog output board.

The low analog output (0 mA, 4 mA, 0V, or -10V) may be set to correspond to any low displayed reading **An Lo**. The high analog output (20 mA, 0V or 10V) may be set to correspond to any high displayed reading **An Hi**. The meter will then apply a straight line fit between these two end points to provide an analog output scaled to the meter reading.

KEYSTROKES FOR SETUP

If the **MENU** key does not work, see Section 9 “Enabling & Locking Out Menu Items.”

Press Menu Select Key	Press Digit Select Key	Press Value Select Key
AnSEt Analog Output Setup. Press until AnSEt is displayed (requires analog output board).	 Analog output signal selection.	0 0-20 mA current output 1 0-10V voltage output 2 4-20 mA current output 3 -10 to +10V voltage output
	 Analog output filtering.	0 Analog output unfiltered 1 Analog output filtered
An Lo Low displayed value for 0 mA, 4 mA, 0V, or -10V output	 Select digit to flash.	Select -9 thru 9 for flashing first digit, 0 thru 9 for other flashing digits. Decimal point location is fixed by dEC.Pt selection.
An Hi High displayed value for 20 mA or 10V output	 Select digit to flash.	Select -9 thru 9 for flashing first digit, 0 thru 9 for other flashing digits. Decimal point location is fixed by dEC.Pt selection.

18. SERIAL COMMUNICATION OPTIONS

A **serial communications board** may be connected to the meter main board at plug position P13 (middle position). Available boards are RS232, RS485 (with dual RJ11 connectors), RS485 Modbus (with dual RJ45 connectors), USB, USB-to-RS485 converter, Ethernet, and Ethernet-to-RS485 converter. The dual connectors of RS485 boards are wired in parallel to allow daisy chaining of addressable meters without use of a hub. Three serial communication protocols are selectable for all serial boards: Custom ASCII, Modbus RTU, and Modbus ASCII.

A **USB-to-RS485 converter board** or an **Ethernet-to-RS485 converter board** allows a meter to be interfaced to a computer and be the device server for a network of up to 31 other meters on an RS485 bus, while itself retaining all capabilities of a meter. The remote meters need to be equipped with our RS485 digital interface board with dual 6-pin RJ11 jacks, not our RS485 digital interface with dual 8-pin RJ45 jacks. The dual 6-pin RJ11 jacks on the RS485 board are wired in parallel to allow multiple meters to be daisy-chained using 6-wire data cables with no need for hand-wiring or an RS485 hub. The outer two wires are used for ground.

Use 6-wire, straight-through data cables, not 4-wire telephone cables or crossover cables, all the way from the device server to the last device on the RS485 bus. Connect ATX to ATX, BTX to BTX, etc., with no crossover as you go from device to device.

To connect a meter with a USB board to a Windows PC, use a USB cable with Type A and Type B connectors. Upon first connection, your computer may display “Found new Hardware” and automatically download and install the required USB driver from the Internet. If installation is not automatic, download the driver file (with a name like CDM v2.10.00 WHQL Certified.zip) from [_____](#). Unzip it into its own directory, and point to that directory as the location of the driver. You will need to use Device Manager (accessible from Control Panel) to determine the com port. Go down the device list and click on PoM & LPT) and USB serial port (com #). Note the com port # for use with communications to your meter, then exit Control Panel. If you later need to change the Com port, right-click on USB serial port (com #), then on Properties, Port settings, and Advanced. Change port to the desired number, click OK, then exit Control Panel.





To connect a meter with an Ethernet board to a computer, see our separate Ethernet Manual, which covers our Node Manager Software. This Windows-based application runs on a host computer and is used to configure our Ethernet Nodes. It automatically discovers all Nodes on a LAN or WAN, plus any devices connected to Server Nodes via an RS485 bus. It is used to configure each Node, such as setting communication parameters, naming the Node and associated devices, entering email addresses for alarm notification and data requests, selecting the Node's time zone for time-stamping of emails and streaming data, and upgrading firmware. Once configuration data has been stored in flash memory of all Nodes, Node Manager Software can be closed. Node resident web server software is also provided.

BOARD SETUP VIA JUMPERS

USB Board

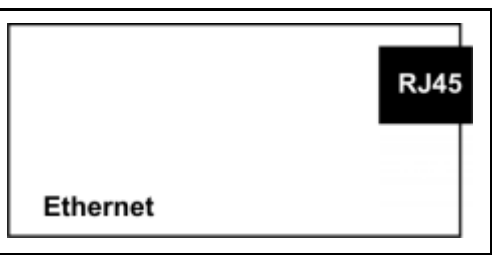
No jumpers required.

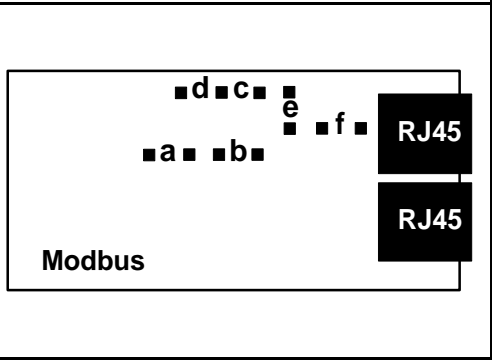

<p>Basic Ethernet Board No jumpers needed.</p>	
<p>RS232 Board e - Do not use (except for externally enabled RTS). Prevents use of Instrument Setup PC software. f - Do not use. g - Installed for normal operation. Note: Board is shipped with jumper g installed.</p>	
<p>RS485 Board, Full Duplex Operation b & d - Installed on last meter in long cable run. RS485 Board, Half Duplex Operation a & c - Installed for half duplex operation. d - Installed on last meter in line with long cable runs. Note: Board is shipped with no jumpers installed.</p>	
<p>RS485-Modbus Board, Full Duplex Operation b & e - Bias jumpers should be installed on 1 board. a & d - Installed on last meter in long cable run. RS485-Modbus Board, Half Duplex Operation b & e - Bias jumpers installed on 1 board. c & f - Installed for half duplex operation. a - Installed on last meter in line with long cable runs. Note: Board is shipped with no jumpers installed.</p>	
<p>Ethernet-to-RS485 Converter Board & USB-to-RS485 Converter Board Full Duplex Operation No jumpers for short cable runs. Add b for long cable runs. Half Duplex Operation a & c - Installed for half duplex operation.</p>	 

For remote (or slave DPM operation), see the section “Command Mode for Remote Display Operation of DPM” in our separate “Custom ASCII Protocol Serial Communications Manual.” The first position of a transmitted number must be a blank, + sign or - sign. Five digits and a decimal point must be transmitted. Leading 0’s serve as blanks.

SERIAL CONNECTION EXAMPLES

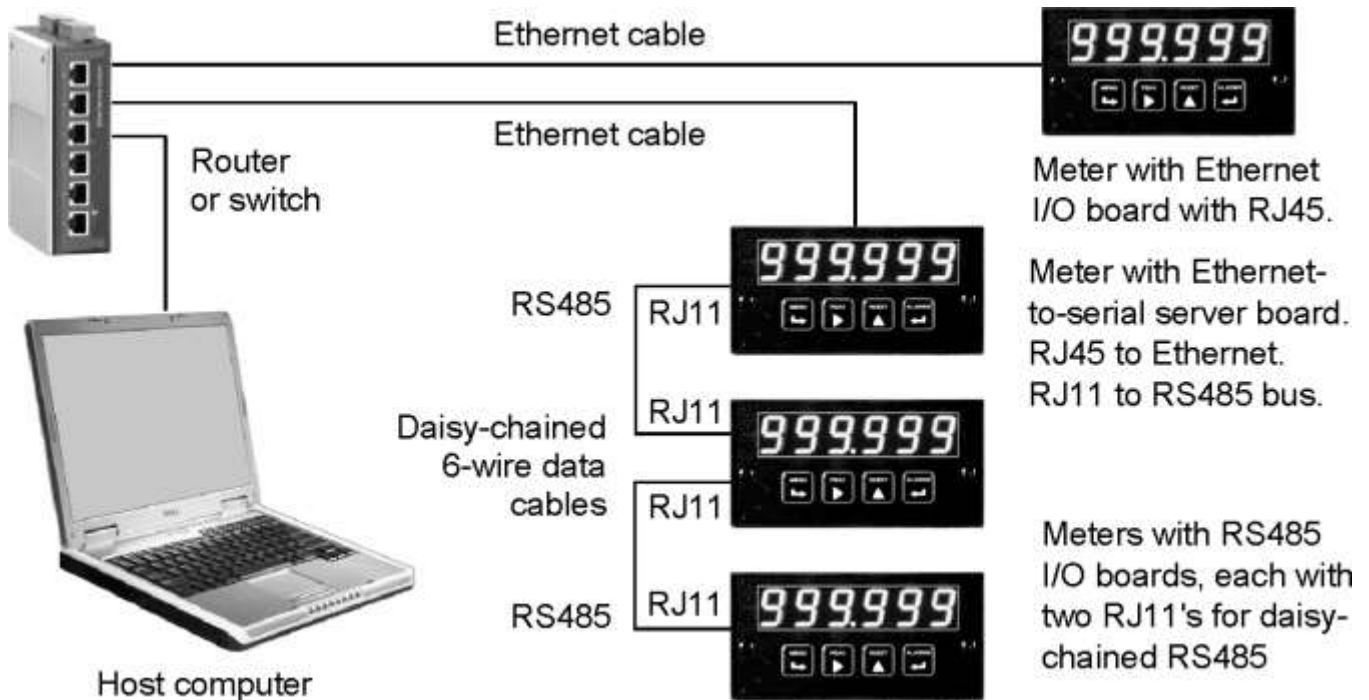
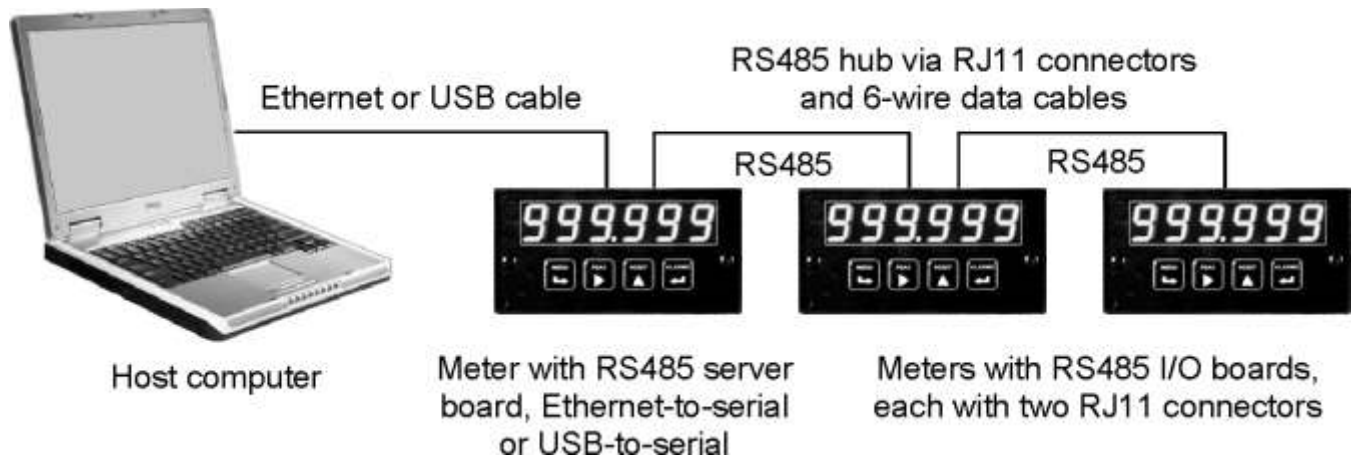
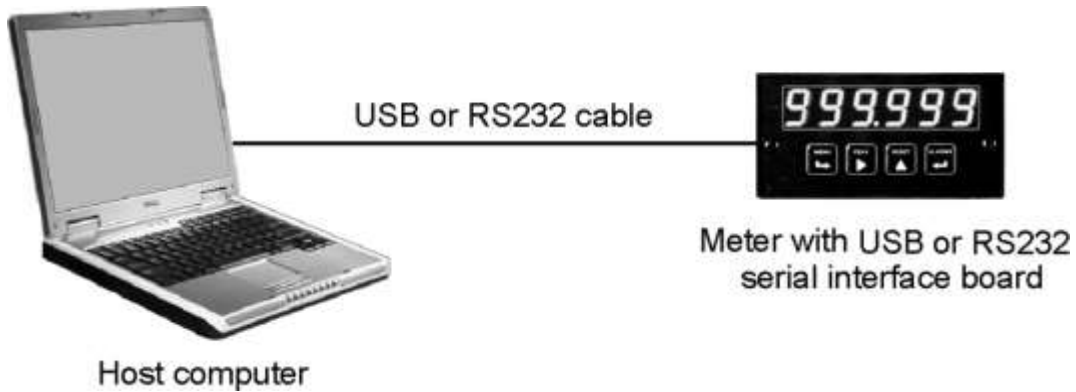

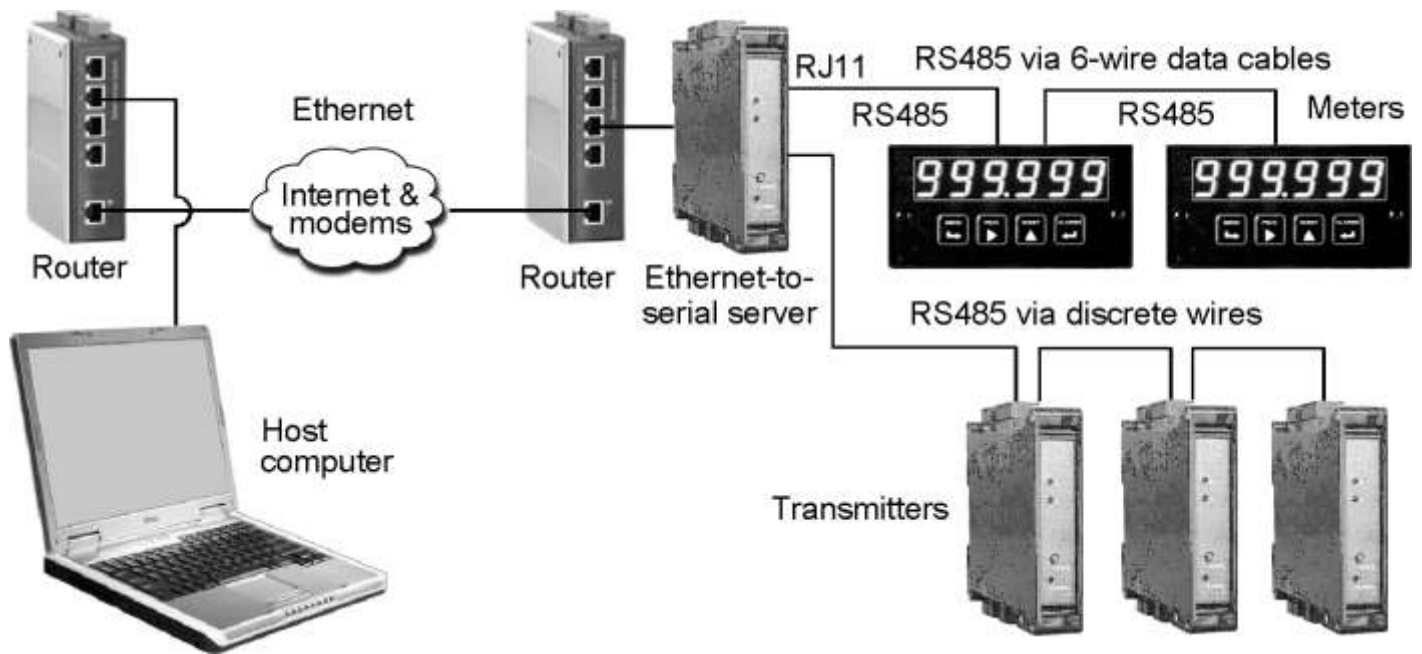



KEYSTROKES FOR SETUP

If the *MENU* key does not work, see Section 9 “Enabling & Locking Out Menu Items.”

MENU Press Menu Select Key	PEAK Press Digit Select Key	RESET Press Value Select Key																							
SEr 1 Fixed Parameters: No parity 8 data bits 1 stop bit	 Output filtering	0 Send unfiltered signal 1 Send filtered signal																							
	 Baud rate	0 300 baud 1 600 baud 2 1200 baud 3 2400 baud 4 4800 baud 5 9600 baud 6 19200 baud																							
	 Output update rate	<table border="0"> <tr> <td>0 60 Hz</td> <td>50 Hz</td> </tr> <tr> <td>1 Line frequency</td> <td>Line frequency</td> </tr> <tr> <td>2 0.28 sec</td> <td>0.34 sec</td> </tr> <tr> <td>3 0.57 sec</td> <td>0.68 sec</td> </tr> <tr> <td>4 1.1 sec</td> <td>1.4 sec</td> </tr> <tr> <td>5 2.3 sec</td> <td>2.7 sec</td> </tr> <tr> <td>6 4.5 sec</td> <td>5.4 sec</td> </tr> <tr> <td>7 9.1 sec</td> <td>10.9 sec</td> </tr> <tr> <td>8 18.1 sec</td> <td>21.8 sec</td> </tr> <tr> <td>9 36.6 sec</td> <td>43.5 sec</td> </tr> <tr> <td></td> <td>72.5 sec</td> </tr> <tr> <td></td> <td>97 sec</td> </tr> </table>	0 60 Hz	50 Hz	1 Line frequency	Line frequency	2 0.28 sec	0.34 sec	3 0.57 sec	0.68 sec	4 1.1 sec	1.4 sec	5 2.3 sec	2.7 sec	6 4.5 sec	5.4 sec	7 9.1 sec	10.9 sec	8 18.1 sec	21.8 sec	9 36.6 sec	43.5 sec		72.5 sec	
0 60 Hz	50 Hz																								
1 Line frequency	Line frequency																								
2 0.28 sec	0.34 sec																								
3 0.57 sec	0.68 sec																								
4 1.1 sec	1.4 sec																								
5 2.3 sec	2.7 sec																								
6 4.5 sec	5.4 sec																								
7 9.1 sec	10.9 sec																								
8 18.1 sec	21.8 sec																								
9 36.6 sec	43.5 sec																								
	72.5 sec																								
	97 sec																								

MENU  Press Menu Select Key	PEAK  Press Digit Select Key	RESET  Press Value Select Key
SEr 2 Serial Setup 2	0000 Line feed	0 No line feed after carriage return 1 Line feed after carriage return
	0000 Alarm data with readings	0 No alarm data 1 Alarm data with reading
	0000 Control of data output	0 Continuous data output 1 Data output on ASCII command only
	0000 Meter address with Custom ASCII protocol	Select 1 thru F for addresses 1 thru 15. Select 0. thru F. (with decimal point) for addresses 16 thru 31.
SEr 3 Serial Setup 346	00000 Half or full duplex	0 Half or full duplex 1 Do not use
	00000 Special start & stop char.	0 Standard continuous mode 1 Special start & stop characters
	00000 RTS mode (for RS232)	0 Normal RS232 operation 1 Single RS232 transmission mode with -e jumper on RS232 board
	00000 Termination characters	0 Only at end of all items 1 At end of each item
	00000 Data sent in continuous mode	0 Reading 1 Peak 2 Valley 3 Reading + peak 4 Reading + valley 5 Reading + peak + valley
SEr 4 Serial Setup 4.	000 Modbus ASCII gap timeout	0 1 sec 1 3 sec 2 5 sec 3 10 sec
	000 Serial protocol	0 Custom ASCII 1 Modbus RTU 2 Modbus ASCII
	000 Parity	0 None, 2 or more stop bits 1 Odd, 1 or more stop bits 2 Even, 1 or more stop bits
Addr Modbus Address. Appears only if the Modbus protocol is selected.	000 000 000 Select digit to flash.	247 Select 0 through 9 for flashing digit. Address range is 1 to 247.

19. EXCITATION OUTPUTS

Jumpers in upper right

Jumpers b, c, d, e, f in the upper right of the power supply board allow selection of one of three available transducer excitation outputs. These are isolated to 50 Vdc from signal common, to 250 Vac from power, and to 2 kV from meter output options. The same jumper locations apply to the universal AC power supply (85-264 Vac) and to the low voltage power supply (12-32 Vac or 10-48 Vdc). When these jumpers are not installed, an external reference voltage up to 20 Vdc can be applied to the meter for ratiometric operation.

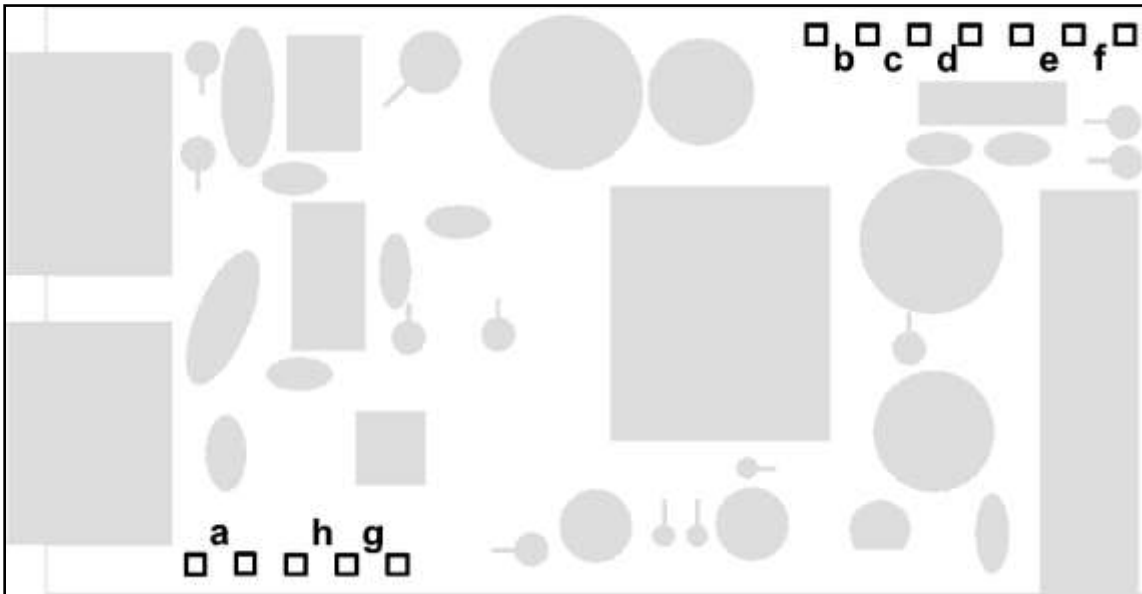

Excitation output	Jumper locations									
5 Vdc \pm 5%, 100 mA max	b, d, e	<table style="border: none; margin: auto;"> <tr> <td style="text-align: center;">b</td> <td style="text-align: center;">d</td> <td style="text-align: center;">e</td> <td style="text-align: center;">■</td> </tr> <tr> <td style="text-align: center;">■</td> <td style="text-align: center;">■</td> <td style="text-align: center;">■</td> <td style="text-align: center;">■</td> </tr> </table>	b	d	e	■	■	■	■	■
b	d	e	■							
■	■	■	■							
10 Vdc \pm 5%, 120 mA max	b, d, f	<table style="border: none; margin: auto;"> <tr> <td style="text-align: center;">b</td> <td style="text-align: center;">d</td> <td style="text-align: center;">f</td> <td style="text-align: center;">■</td> </tr> <tr> <td style="text-align: center;">■</td> <td style="text-align: center;">■</td> <td style="text-align: center;">■</td> <td style="text-align: center;">■</td> </tr> </table>	b	d	f	■	■	■	■	■
b	d	f	■							
■	■	■	■							
24 Vdc \pm 5%, 50 mA max	c	<table style="border: none; margin: auto;"> <tr> <td style="text-align: center;">c</td> <td style="text-align: center;">■</td> <td style="text-align: center;">■</td> <td style="text-align: center;">■</td> </tr> <tr> <td style="text-align: center;">■</td> <td style="text-align: center;">■</td> <td style="text-align: center;">■</td> <td style="text-align: center;">■</td> </tr> </table>	c	■	■	■	■	■	■	■
c	■	■	■							
■	■	■	■							
None	No jumpers									

Jumpers in lower left

Jumpers a, h, g in the lower left of the power supply board provide special features when installed:

- Jumper a** Front panel menus are locked out when installed. See Section 9.
- Jumper h** Connects "Control Input 2" to P1-4 when installed.
- Jumper g** Provides non-isolated +5 Vdc, 30 mA power output at P1-4 when installed. This power is in addition to the isolated excitation output set by jumpers in the upper right of the board.

20. INSTRUMENT SETUP VIA PC

Instrument Setup (IS) Software is a PC program which is at no charge and is easier to learn than front panel programming. With the meter connected to the PC, it allows uploading, editing and downloading of setup data, execution of commands under computer control, listing, plotting and graphing of data, and computer prompted scaling. With the meter unconnected to a PC, it provides quick selection of jumper locations and a printable display of menu selections for front panel setup.

SOFTWARE INSTALLATION

Under Windows 7 or 10, set User Account Control (UAC) to “Never Notify” so that IS software can write files. Turn off and restart your computer. Download *IS2*.exe* onto your PC from our website. Double-click on the downloaded file to unzip it into a directory, such as *c:\temp*. Within that directory, double-click on *setup.exe* to install the software on your PC.

PREREQUISITES FOR CONNECTED USE

- 1) PC with an available communication port.
- 2) Meter to be set up.
- 3) Communication board in meter. This board can be removed following meter setup.
- 4) Communication cable from meter to PC.
- 5) *Instrument Setup* software.

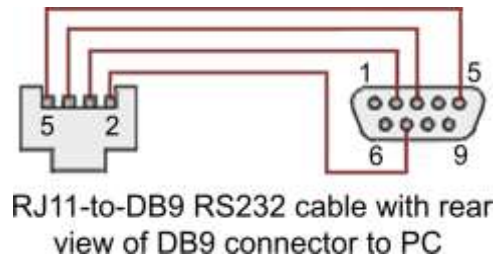

ESTABLISHING COMMUNICATIONS

Connect the meter and PC. Apply power to the meter. Be sure that the meter is in Run Mode, not Setup Mode. To start the software from Windows, click on *Start => Programs => IS2 => IS2*. Click on *RS232 => Establish*. The program will temporarily set the selected Com port to the required baud rate, parity, data bits and stop bit. Once communications have been established, click on *Main Menu*. The software will sense the type of meter and installed boards, but it cannot sense jumper positions nor set jumpers for you. If the computer is not connected to a meter, select *DPM* and *Series 2*.

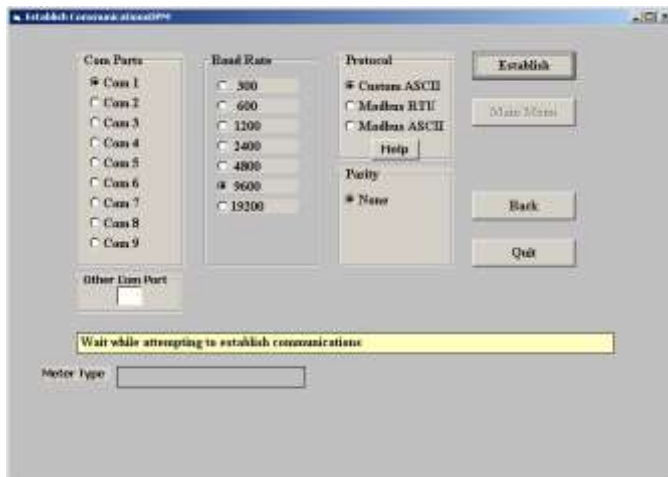

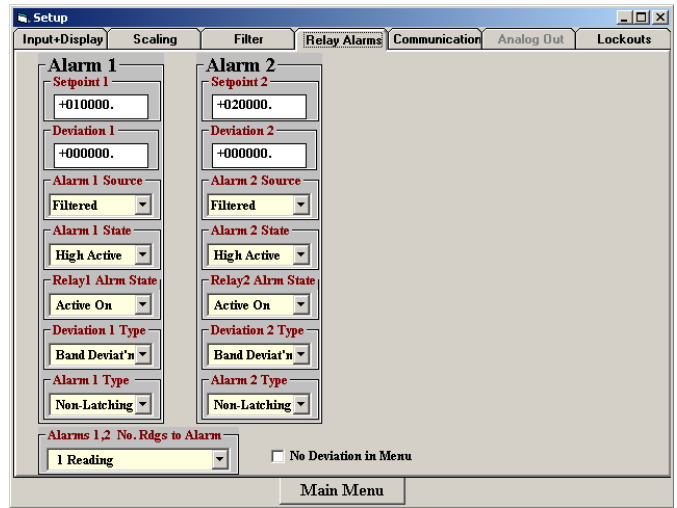
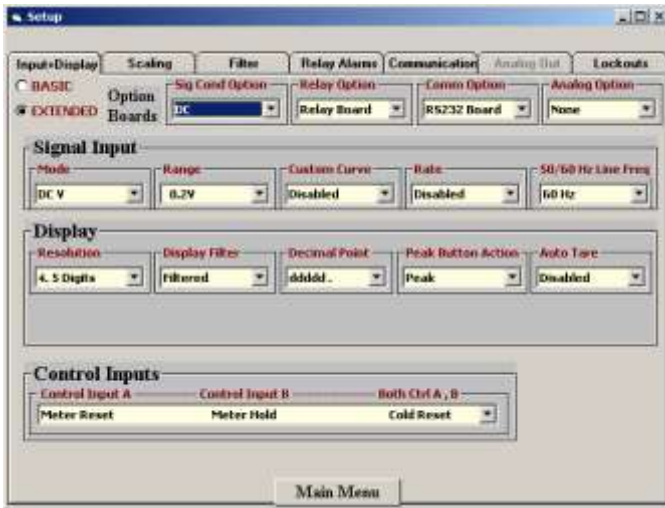

SETUP OF CONNECTED METER

A setup file can be retrieved from the meter (*DPM => Get Setup*), be edited (*View => Setup*), be saved to disk (*File => Save Setup*), be retrieved from disk (*File => Open Setup*), and be downloaded into one or multiple meters (*DPM => Put Setup*). Downloading of setup files from a PC can be a major time saving when multiple meters have to be set up in the same way.

You will find that *Instrument Setup software* is very user friendly, with separate tab-selectable windows for *Input+Display*, *Scaling*, *Filter*, *Relay Alarms*, *Communications*, *Analog Out*, and *Lockouts*. If the required hardware, such as the analog output board, is not sensed, the corresponding tab will be grayed out.

ADDITIONAL FEATURES

- **The Commands pull-down menu** allows you to execute certain meter functions by using your computer mouse. You can reset individual meter functions, display current or peak readings, and enter numbers to be displayed remotely by the DPM. The first position of a transmitted number must be a blank, + sign or - sign. Five digits and a decimal point must be transmitted. Leading 0's serve as blanks. The *Commands* pull-down menu will be grayed out unless a *Get Setup* has been executed.

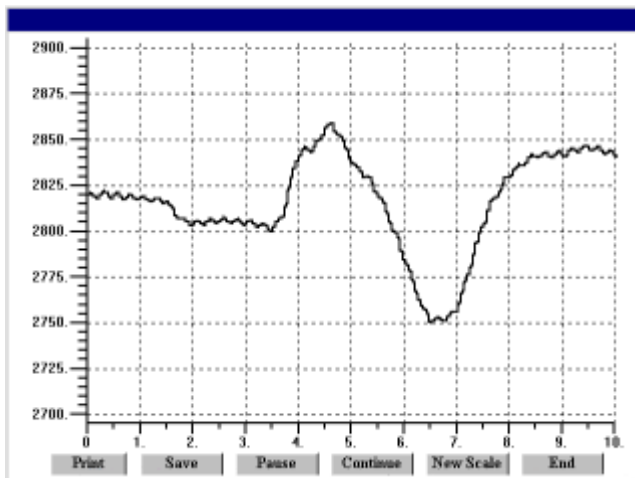

Plot

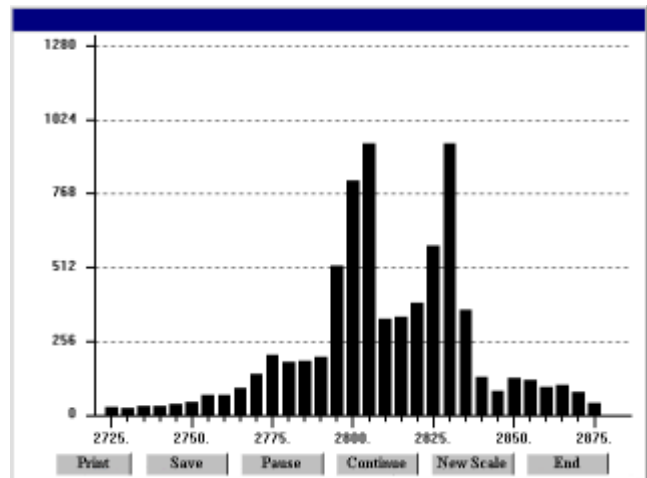

Graph

- **The Readings pull-down menu** provides three formats to display DPM data on the PC monitor. Use the *Pause* and *Continue* buttons to control the timing of data collection, then press **Print** for a hardcopy using your PC printer.
 - **List** presents the latest readings in a 20-row by 10-column table. Press *Pause* at any time to freeze the display. Press *Print* for a hardcopy. *List* can capture peak readings.
 - **Plot** generates a plot of readings vs. time in seconds. It effectively turns the DPM-PC combination into a printing digital oscilloscope.
 - **Graph** generates a histogram, where the horizontal axis is the reading and the vertical axis is the number of occurrences of readings. The display continually resizes itself as the number of readings increases.
- **The Jumpers pull-down menu** provides jumper positions for the various meter boards, duplicating information in this manual.
- **The Calibration pull-down menu** allows easy calibration of voltage and current ranges for the DC, load cell, and AC RMS signal conditioner boards. The PC first recognizes the type of board, then prompts you to apply specific jumpers and calibration signals. Press *Ready* to take a reading. Press *Repeat* to take more readings. When you have decided on which reading to accept, press on the number 1 through 10 of that reading. Additional calibration software is available online.

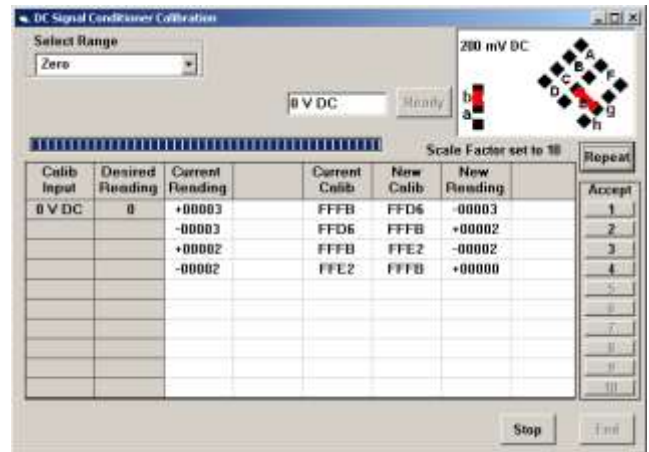

METER SETUP WITH AN UNCONNECTED PC

Instrument Setup software is also of benefit when the PC is not connected to a meter. Upon launching the software, click on *None* for *Communications*, then on *DPM* and *Series 2*. Click on *File => Default Setup* to retrieve a default setup file from disk, or on *File => Open Setup* to retrieve a previously saved setup file from disk.

To enter new setup information, click on *View => Setup*, then make your screen selections as if you were connected to a meter. Tabs will be grayed out if you have not selected the required hardware under the *Input+Display* tab. When done, press on *Main Menu*, then on *View => Menu*. The selections made under *Setup* will now be shown in the form of the required front panel programming sequence, where each row corresponds to a menu item selected by the **↩** key, and the seven data columns correspond to values entered via the **▶** and **▲** keys.

MENU KEY	S	1	2	3	4	5
InPut			d	C		V
SEtuP		0	0	0	0	0
ConFIG		0	0	0	0	0
FILtEr		0	0	1	1	6
DecPt		d	d	d.	d	d
SCALE		0	0	0	1	0
OFFSt		0	0	0.	0	0
SEr 1				0	5	0
SEr 2			0	0	1	1
Loc 1		0	0	0	0	0
Loc 2			0	0	1	0
Loc 3			0	0	0	0

Click on any step in the sequence to bring up a detailed help window.

Click on *Print* for a hardcopy, which you can then use as an instruction sheet to program your meter via its front panel.

Click on *Main Menu => File => Save Setup As* to save your setup to disk and have an electronic record.

21. CUSTOM CURVE LINEARIZATION

Curve.exe is a DOS-based, executable PC program used to set up an Extended meter so that the readings have a user-defined, non-linear relationship with the input signal. The calculated linearizing parameters are downloaded into non-volatile memory of the meter. For example, it allows a meter to correct for transducer nonlinearity or to display volume of an irregularly shaped tank based on liquid level. The curve-fitting algorithm uses quadratic segments of varying length and curvature, and provides diagnostics to estimate curve fitting errors. The program is self-prompting, avoiding the need for a detailed printed manual. This manual section is only intended as an introduction and get-started guide.

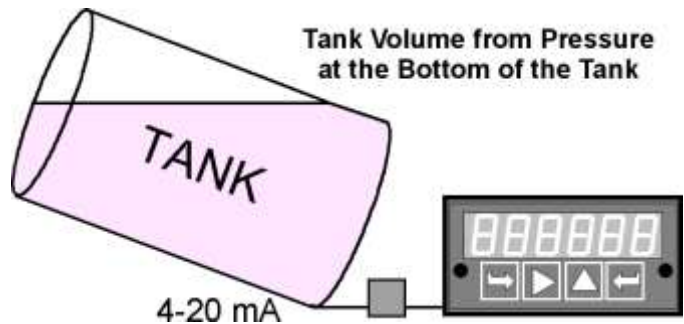

PREREQUISITES

- 1) PC-compatible computer with an available RS232 or USB port.
- 2) Extended meter.
- 3) An RS232 or USB board in the meter. This board can be removed following meter setup.
- 4) An RJ11-to-DB9 RS232 cable or a USB cable to connect the meter to the PC (see Section 1, Ordering Guide).
- 5) *Curve.exe* software (downloadable from the web at no charge).

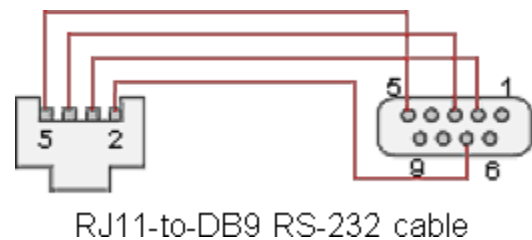

GETTING STARTED

Download *curve.exe* into the same directory that will contain your data files, such as *c:\curves*. Set the meter baud rate to 9600. To do so, press the **→** key to get to **Ser 1**, then set the entry to **050**. Set the meter address to 1. To do so, press the **→** key to get to **Ser 2**, then set the entry to **0011**. To execute the program from Windows, simply double-click on *curve.exe*, which is an executable file. Follow the steps on computer screens, which will prompt you and provide extensive information. Pressing **R** (Enter) returns to the main menu.

You will be given the choice to enter your data in one of four modes:

- 1) **Text file entry mode**, with an X value in one column and a Y value in another. There can be additional columns, which are ignored. The file must have a DOS name of up to 8 characters and the extension *.RAW*. There can be from 5 to 180 rows. X is the input value and should be in the unit of measure for which the meter was set up, such as mV, V, mA or A. Y is the desired corresponding reading and can range from -99999 to 99999 with any decimal point.
- 2) **2-coordinate keyboard entry mode**, where an actual X input signal is applied, and the desired Y reading is entered from the keyboard.
- 3) **2-coordinate file entry mode**, where an actual X input signal is applied, and the desired Y reading is provided from a file.

- 4) **Equation entry mode**, where the coefficients of a polynomial $Y = K1X^{P1} + K2X^{P2} + K3X^{P3} + \dots$ are entered. Up to 20 terms are allowed. An offset can be built into X.

You will be asked if your DPM has a revision of DPM4L or later. You will normally select **2** (yes), since revision DPM4L started to ship in August 2000.

You will be asked to supply the following:

LOW X-COORDINATE VALUE >
LOW INPUT MEASUREMENT VALUE >
HIGH X-COORDINATE VALUE >
HIGH INPUT MEASUREMENT VALUE >

This informs the computer of your signal conditioner jumper settings. Enter 0 and 0 for the two LOW values. For HIGH X, enter your signal conditioner jumper range in the same units of measure that you will be using in your *.RAW data input file. Enter **20** for 20 mV or 20V. Enter **200** for 200 mV or 200V. Enter **5** for 5A AC or DC. For HIGH INPUT MEASUREMENT VALUE, enter **20000**, except for 5A DC, where you should enter **5000**.

Position of the decimal point from 6=X.XXXXX, 5= XX.XXX, 4=XXX.XXX, 3=XXXX.XX, 2=XXXXX.X, 1=XXXXXX (for DPMs, the leading X is a blank). Specify the same position that you specified in the **dEc.Pt** decimal point menu selection.

Follow the steps on the screens to finish generating the custom curve. When prompted to download the file to the meter, select **Y**. When prompted to set the meter to custom curve mode, also select **Y**.

KEYPAD CONTROL

You can take a meter in and out of custom curve linearization using the meter keypad. From the Menu mode, press the **↩** key to get to **ConFG**, then set the fifth digit to either **0** (normal linear operation) or to **1** (custom curve operation). This fifth digit will only be displayed with an Extended meter.

FILES USED OR CREATED BY CURVE.EXE

- 1) ***.RAW** is the raw input file generated by all four data entry methods.
- 2) ***.DVD** adds three columns from which the smoothness of the input data and obvious input errors can be judged. The more data points and the smoother the data, the better the curve fit.
- 3) ***.NUM** lists Y readings prior to custom curve linearization and addition of the decimal point.
- 4) ***.CCF** is an internal file used by the software.
- 5) ***.SIM** lists simulated linearized meter readings and calculated corresponding errors.
- 6) ***.PRM** contains the final hex data that is downloaded into the meter.

22. METER CALIBRATION

All analog input and analog output ranges of the meter have been digitally calibrated at the factory prior to shipment using calibration equipment certified to NIST standards. Calibration constants are stored digitally in non-volatile memory in EEPROM on the signal conditioner board and analog output board. This allows the boards to be changed without requiring meter recalibration. Digital calibration also eliminates much of circuitry that would be associated with analog calibration, providing superior long term accuracy and stability.

If periodic recalibration is required, the meter may be returned to the factory or to any authorized distributor. A modest fee will apply, which also covers a Calibration Certificate.

DC, load cell, AC RMS, and thermocouple signal conditioner boards can be calibrated using Instrument Setup Software running on a host PC (Section 20). An RS232, RS485, USB or Ethernet interface board must be installed in the meter for communication to the PC. This board may be removed following calibration. A certified, calibrated signal source is also required. The Calibration screen of Instrument Setup Software is accessed by clicking on Calibration at the top of the DPM Main Menu screen. The PC first recognizes the type of board, then prompts you to apply specific jumpers and specific known signals for each range. Press Repeat to take more readings. When you have decided on which reading to accept, press on the number 1 through 10 of that reading.

The RTD/Ohms signal conditioner board cannot be calibrated using the Calibration screen of Instrument Setup Software. Instead, use the Scaling tab under Setup. Here you can enter values for Scale and Offset for a specific range. These corrections apply to resistance, not to RTD temperature. To calibrate RTD temperature, refer to the published resistance table for your RTD type, and calibrate resistance. For example, if your measured resistances are 0.1% low, apply a scale factor of 1.01.

23. SPECIFICATIONS

Meter Display

Type5 LED, 7-segment, 14.2mm (.56") high digits & 3 LED indicators
Color..... Red or green
Range..... -99999 to +99999 and -99990 to +99990

A to D Conversion

Technique (Pat.5,262,780) Concurrent Slope™
Read Rate 60/s for 60 Hz NMR, 50/s for 50 Hz NMR
Output Update Rate 56/s at 60 Hz, 47/s at 50 Hz
Display Update Rate 3.5/s at 60 Hz, 3/s at 50 Hz

Noise Rejection

CMV from DC to 60 Hz.....Withstand 250Vac
Dielectric strength.....2.3 kV ac for 1 min
CMR from DC to 60 Hz 130 dB
NMR at 50/60 Hz.....90 dB with minimum digital filtering

Control Inputs (CMOS/TTL levels, logic 0 = tied to digital ground, logic 1 = open)

/ Hold input Logic 0 holds display and outputs
/ Peak or Valley input Logic 0 displays peak/valley value
/ Tare input Logic 0 offsets input value to zero
/ Tare Reset..... Logic 0 resets Tare value to zero
/ Reset input Logic 0 resets all meter functions
/ Function Reset input Logic 0 resets peak values and alarms
/ Decimal Point input Overrides internal DP selections and controls DP position
/ Display Blank input..... Logic 0 shuts off the display

Power Requirements

Input Voltage (standard power) 85-264 Vac or 90-300 Vdc
Input Voltage (low voltage power option) 12-32 Vac or 10-48 Vdc
Power Line Frequency DC and 47-63 Hz
Power Consumption (typical, base meter). 1.2W @ 120 Vac, 1.5W @ 240 Vac, 1.3W @
10 Vdc, 1.4W @ 20 Vdc, 1.55W @ 30 Vdc, 1.8W @ 40 Vdc, 2.15W @ 48 Vdc
Power Consumption Adder for four 350 ohm load cells in parallel at 10V 1.2W

Maximum Applied Voltage Signals

Voltage input ranges of 2V and above (AC or DC) 600 Vrms
Voltage input ranges of 200 mV (AC or DC), load cell, thermocouple, RTD ±100 Vdc

Input Types, Ranges, Resolution, Error at 25°C

DC Volts

Range	Resol.	Resist.	Error
200.00 mV 2.0000 V 20.000 V 200.00 V	10 μ V 100 μ V 1 mV 10 mV	1 G Ω 1 G Ω 10 M Ω 10 M Ω	0.01% of FS ± 2 cts
300.0 V 600.0 V*	0.1 V 0.1 V	10 M Ω 10 M Ω	± 0.4 V ± 0.4 V

DC Amps

Range	Resol.	Resist.	Error
2.0000 mA 20.000 mA 200.00 mA	0.1 μ A 1 μ A 10 μ A	100 Ω 10 Ω 1 Ω	0.01% of FS ± 2 cts
5.000 A	1 mA	0.01 Ω	± 10 mA

Process, DC Ratio, Potentiometer Follower

Range	Resol.	Resistance	Error
200.00 mV 2.0000 V 20.000 V	10 μ V 100 μ V 1 mV	1 G Ω 1 G Ω 1 M Ω	0.01% of FS ± 2 cts

True RMS Volts (0% to 100% of Full Scale, 0 Hz and 10 Hz to 10 kHz, crest factor 3.0)

Range	Resol.	Resist.	Error
200.00 mV 2.0000 V 20.000 V 200.00 V	10 μ V 100 μ V 1 mV 10 mV	1 M Ω 1 M Ω 1 M Ω 1 M Ω	0.03% of FS ± 2 cts
300.0V 600.0 V*	100 mV 100 mV	1 M Ω 1 M Ω	± 0.8 V ± 0.8 V

True RMS Amps (0% to 100% of Full Scale, 0 Hz and 10 Hz to 10 kHz, crest factor 3.0)

Range	Resol.	Resist.	Error
2.0000 mA 20.000 mA 200.00 mA	0.1 μ A 1 μ A 10 μ A	100 Ω 10 Ω 1 Ω	0.1% of FS ± 2 cts
5.000 A	1 mA	0.01 Ω	± 20 mA

Thermocouple (0.1°, 1° resolution)

Type	Range	Error
J	-210 to 760°C -347to 1400°F	.01% FS $\pm 0.09^\circ$ C .01% FS $\pm 0.16^\circ$ F
K	-244 to 1372°C -408to 2501°F	.01% FS $\pm 0.10^\circ$ C .01% FS $\pm 0.17^\circ$ F
T	0 to 400°C -257 to 0°C	.01% FS $\pm 0.03^\circ$ C .01% FS $\pm 0.20^\circ$ C
	32 to 752°F -430 to 32°F	.01% FS $\pm 0.05^\circ$ F .01% FS $\pm 0.36^\circ$ F
E	-240 to 1000°C -400 to 1830°F	.01% FS $\pm 0.18^\circ$ C .01% FS $\pm 0.32^\circ$ F
N	-245 to 1300°C -410 to 2370°F	.01% FS $\pm 0.10^\circ$ C .01% FS $\pm 0.17^\circ$ F
S	-46 to +1768°C -51 to +3213°F	.01% FS $\pm 0.12^\circ$ C .01% FS $\pm 0.22^\circ$ F
R	-45 to 1768°C	.01% FS $\pm 0.17^\circ$ C
	-49 to 3214°F	.01% FS $\pm 0.31^\circ$ F

RTD (0.01°, 0.1°, 1° resolution)

Type	Range	Error
Pt 100 Ω .00385	-202 to 850°C -331 to 1562°F	.01% rdg $\pm 0.03^\circ$ C .01% rdg $\pm 0.05^\circ$ F
Pt 100 Ω .003925	-202 to 631°C -331 to 1168°F	.01% rdg $\pm 0.04^\circ$ C .01% rdg $\pm 0.07^\circ$ F
Ni 120 Ω .00672	-80 to 260°C -112 to 500°F	.01% rdg $\pm 0.05^\circ$ C .01% rdg $\pm 0.09^\circ$ F
Cu 10 Ω .00427	-97 to 260°C -143 to 500°F	.01% rdg $\pm 0.05^\circ$ C .01% rdg $\pm 0.09^\circ$ F

Resistance Measurement

Range	Resolution	Error
0-20.000 Ω	1 m Ω	0.01% of reading ± 2 cts
0-200.00 Ω	10 m Ω	
0-2000.0 Ω	100 m Ω	
0-20000 Ω	1 Ω	
0-200.00 k Ω	10 Ω	
0-2.0000 M Ω	100 Ω	

* 600V ranges not ETL certified.

Load Cell Input

Range	Resolution	Resistance	Zero Range	Span Range	Error
20.000 mV	1 μ V	1 G Ω	-99999 to 99999	0 to \pm 99,999	0.01% of FS \pm 2 cts
50.000 mV	1 μ V				
100.00 mV	10 μ V				
250.00 mV	10 μ V				
500.00 mV	10 μ V				

Thermocouple Accuracy

Span Tempco	0.003% of reading/ $^{\circ}$ C 0.0015% of reading/ $^{\circ}$ C for load cell meter
Zero Tempco	0.2 μ V/ $^{\circ}$ C
Reference Junction Accuracy	1 $^{\circ}$ C, 10 $^{\circ}$ C to 40 $^{\circ}$ C

Dual & Quad Relay Options

Power to Relay Option	Powered by meter
Setpoint Setup	Via front panel pushbuttons or RS232/485
Update Rate	56/s at 60 Hz, 47/s at 50 Hz
Response to input signal (min)	Display update rate
Input Signal (selectable)	Filtered or unfiltered input signal
Actuation Modes (selectable)	Above or below setpoint, latching or non-latching, disabled
Output Time Delay (selectable)	1 to 128 readings
Front Panel Enable / Lockout Modes (selectable)	1) Display and change setpoints 2) Display but do not change setpoints 3) Neither display nor change setpoints
Alarm Status Indication	2 or 4 red LED lamps
Status Indication Setup (selectable)	Lit when output is ON or OFF, or disabled

Form C, SPDT Relay Output:

AC Rating	8A @ 240 Vac
DC Rating	8A @ 24 Vdc
Isolation rating between signal common and contacts	250 Vac
Insulation dielectric strength between signal common and contacts	2.3 kV ac for 1 min

Form A, SPST Solid State Relay Output:

AC Rating	120 mA @ 140 Vac
DC Rating	120 mA @ 180 Vdc
Isolation rating between signal common and contacts	250V ac
Insulation dielectric strength between signal common and contacts	2.3 kV ac for 1 min

Analog Output Option

Power to Analog Output Option	Powered by meter
Output Levels	0-20 mA, 4-20 mA, 0-10V, -10 to +10V
Voltage Compliance, 0-20 mA Output	12V (0-600 Ohm load)
Current Compliance, 0-10V, -10 to +10V Output	2 mA (5 kOhm or higher load)
Accuracy	Meter input accuracy \pm 0.02% of full scale analog output
Resolution	16 bit (1 part in 65,536)
Response Time	50/60Hz update rate
Scaling of Reading for Zero Output	-99,999 to +99,999

24. GLOSSARY OF TERMS

Adaptive Filter Threshold

A threshold which causes an adaptive moving average filter to be reset to the latest reading when the accumulated difference between individual readings and the filtered reading exceeds that threshold. Adaptive moving average filtering allows a meter to respond rapidly to actual changes in signal while filtering out normal noise. The accumulated difference is also reset to zero when the latest reading has a different polarity than the filtered reading. A low adaptive filter threshold is normally selected. A high filter threshold should be selected if the signal has large transients.

Alarm, Latched

An alarm which stays actuated until reset. Latched alarms can shut down machinery or a process when an operating limit has been exceeded, or maintain an alarm condition until acknowledged by an operator.

Alarm, Non-latched

An alarm which changes state automatically when the reading rises above a specified limit and changes back automatically when the reading falls below a limit.

Autofilter

A selectable digital filter mode which automatically selects an appropriate moving average filter time constant from 0.08 sec to 9.6 sec for the encountered noise condition.

Auto-tare

A selectable meter operating mode, where the first reading following power-on or meter reset is used to zero the display. Further readings are then relative to this new zero.

Batch Average Filter

A digital filter mode which averages 16 readings and then displays the average. Readings are taken at 60/sec with 60 Hz power and 50/sec with 50 Hz power.

Counts

The reading displayed on the panel meter ignoring the decimal point. One count = one unit of resolution.

Custom ASCII Protocol

A simplified, short protocol for use with these panel meters. It allows 31 digital addresses. Not an industry-standard protocol, like the more complex *Modbus protocol*, which is also offered with the meters.

Deviation Band

A band in counts which controls relay action symmetrically around a *setpoint*. The relay actuates when the reading falls within the

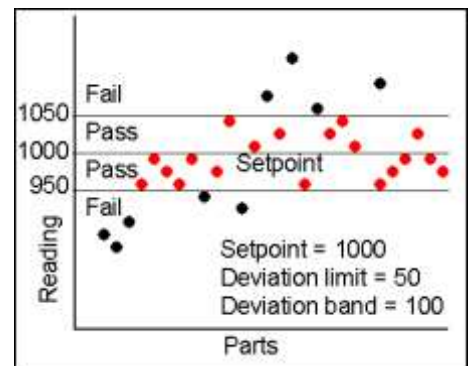
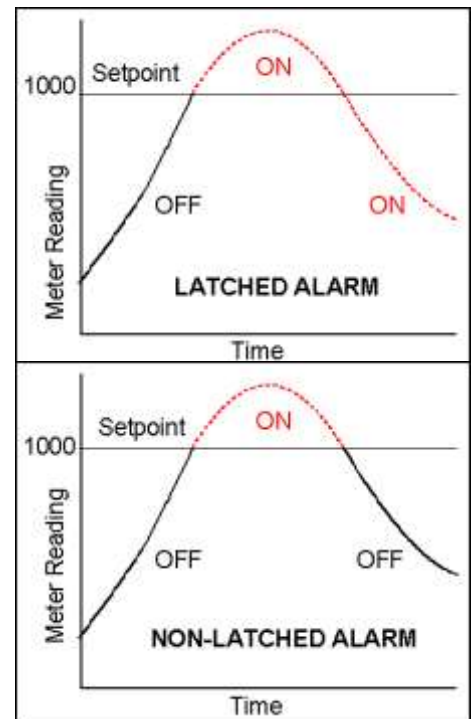

deviation band, and de-actuates when the reading falls outside. A limit (e.g., 50 counts) is set up around both sides of the setpoint to create a deviation band (e.g., 100 counts). Setting up a passband around a setpoint is often used for component testing. Deviation limits are programmed by entering menu item *dEU1b* for Alarm 1 and *dEU2b* for Alarm 2. The deviation band equals two limits.

Display Blank

A rear panel input which blanks the display when the input is tied to logic ground by a switch or when 0V is applied (logic level true). The meter display will light when the input is open or is held at +5V (logic level false).

Extended Meter

A digital panel meter with an enhanced firmware that provides added capabilities, namely linearization of nonlinear inputs and display of rate of change from successive readings.

Full Scale

The maximum input signal range for which the meter has been configured. For example, the most sensitive full scale for the load cell meter is ± 20 mV (signal range from -20 mV to +20 mV).

Function Reset

The action of resetting Peak, Valley, and latched alarms. Takes about 20 msec. Normally achieved by an external pushbutton switch, which connects a control input 1 or 2 at the rear of the meter to digital ground. The functions of control inputs are programmed under Setup. Peak and Valley can also be reset by simultaneously pressing the RESET and PEAK keys. Latched alarms can also be reset by simultaneously pressing the RESET and ALARM keys.

Ground Loop

A closed conductive path in external ground wiring that allows stray currents to flow in ground wiring, creating ground noise. The meters in this manual minimize ground loop problems by mutually isolating the grounds associated with meter power, signal input, and all output and communication options.

Jumper

A push-on component which provides a short between two adjacent posts on a circuit board. Jumpers are used to configure signal conditioner boards for specific signal types and full scale ranges, and to configure power supply and communications boards for various modes of operation. Unused jumpers are stored by pushing one side over an unused post.

Hysteresis, Split

Relay operation is specified symmetrically around a setpoint. The relay closes (or opens) when the reading rises above the setpoint plus one hysteresis limit, and opens (or closes) when the reading falls below the setpoint less one hysteresis limit. A narrow hysteresis band can be used to minimize relay chatter. A wide hysteresis band can be used for control.

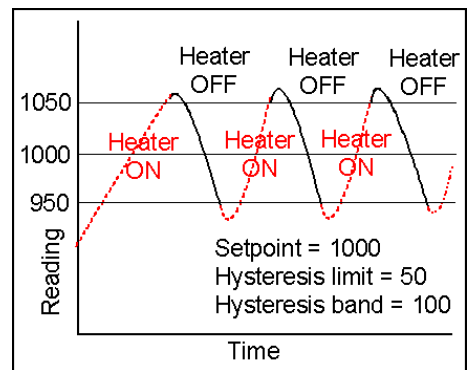

Hysteresis, Span

Same relay operation as for split hysteresis, but specified differently. Here the setpoint is the upper control limit, and the lower control limit is the setpoint less the hysteresis band.

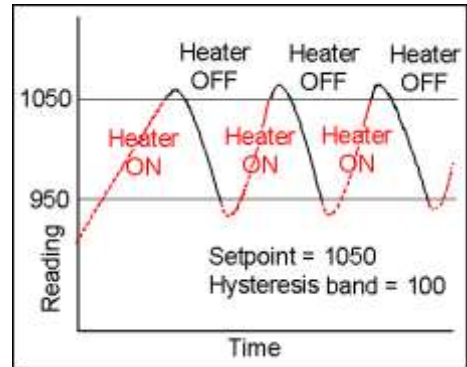

Menu Mode The meter programming mode used for input and range selection, meter setup, and meter configuration. Entered into from the Run mode by pressing the *MENU* key. The Menu mode can be locked out completely by a jumper.

Meter Hold A rear panel input which freezes the meter display and all meter outputs while that input is tied to logic ground by a switch or is held at 0V (resume operation when the input is allowed to float or is held at +5V (logic level false).

Meter Reset Causes the meter to reinitialize and take a tare reading when set up for auto-tare. Takes about 2-3 sec. rESEt is displayed briefly. Achievable by removing and reapplying power to the meter, by simultaneously pressing the RESET and MENU keys, by supplying an ASCII command, by stepping through all top-level menu choices, or by grounding a rear panel control input 1 or 2 if so programmed under Setup.

Modbus An industry-standard serial communications protocol which allows devices by different manufacturers to be digitally addressed by a PC on the same communication line, with up to 247 digital addresses. More complex than the *Custom ASCII* protocol, which is also supported by these meters.

Moving Average Filter

A digital filter mode which displays a weighting moving average of readings. Readings are taken at 60/sec with 60 Hz power and 50/sec with 50 Hz power. Display update rates remain 3.5/sec with 60 Hz power and 3.0/sec with 50 Hz power. There are eight moving average modes:

- Old average x 1/2 + new reading x 1/2 (equivalent to 0.08 sec RC time constant).
- Old average x 3/4 + new reading x 1/4 (equivalent to 0.15 sec RC time constant).
- Old average x 7/8 + new reading x 1/8 (equivalent to 0.3 sec RC time constant).
- Old average x 15/16 + new reading x 1/16 (equivalent to 0.6 sec RC time constant).
- Old average x 31/32 + new reading x 1/32 (equivalent to 1.2 sec RC time constant).
- Old average x 63/64 + new reading x 1/64 (equivalent to 2.4 sec RC time constant).
- Old avg. x 127/128 + new reading x 1/128 (equivalent to 4.8 sec RC time constant).
- Old avg. x 255/256 + new reading x 1/256 (equivalent to 9.6 sec RC time constant).

Offset A constant adder used for the displayed reading. This is the term *b* in the straight line formula $y = mx + b$, where *y* is the displayed reading in counts, *m* is the scale factor, *x* is the measured reading in counts, and *b* is the offset. For direct readout in (milli)volts or (milli)amps, *offset* is 0.

Peak Display The maximum (or most positive) reading since that maximum was last reset. Reset can be via the meter front panel, an external input, or a software command. The displayed value can reflect the filtered or unfiltered readings.

Process Signal A signal whose display requires setup of *scale* and *offset* settings for display in engineering units. A classical process signal is 4-20 mA, where the 4 mA and 20 mA end points can each correspond to a desired meter reading.

Rate of Change Meter

A configuration mode of the *Extended meter* which allows the display of rate based on successive readings. The conversion to engineering units is achieved with the combination of a multiplier from 0.1 to 10,000 and a scale factor.

Reading

The value displayed by the meter. "Taking a reading" is the action of the meter to make an analog-to-digital conversion. Readings are taken at 60/sec with 60 Hz power or 50/sec with 50 Hz power, and are displayed with an update rate of 3.5/sec with 60 Hz power or 3.0/sec with 50 Hz power.

Remote Display

A display mode which allows the meter to serve as a remote display to another meter when connected to it by a 4-wire phone cord. Also allows the meter to transmit raw measurement data to a computer and then display processed data from the computer. A serial communications option board is required in the meter. If such a board is not installed or no serial data is received, the meter displays *rESEt*.

Reset

See "Function Reset" and Meter Reset."

RS485 Half Duplex

Serial communications implemented with two wires, allowing data transmission in both directions, but not simultaneously.

RS485 Full Duplex

Serial communications implemented with four wires, allowing data transmission in two directions simultaneously.

Run Mode

The normal operating mode of the meter, where readings are taken, as opposed to the *menu mode*.

Scale

A constant multiplier used to go from A/D converter counts to displayed counts. This is the slope term m in the straight line formula $y = mx + b$, where y is the displayed reading in counts, m is the scale factor, x is the measured reading in counts, and b is the offset. For direct readout in (milli)volts or (milli)amps, scale is 1.

Scaling

The process of setting *scale* and *offset* so that the meter converts analog-to-digital conversion counts to engineering units (such as psi).

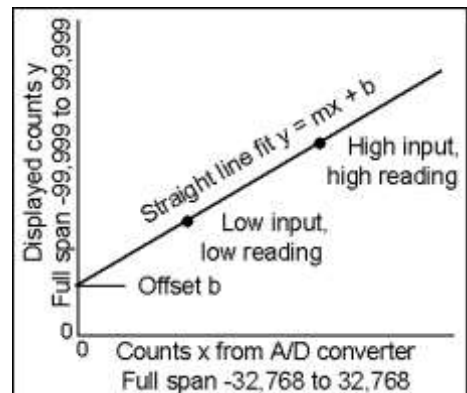

Scaling, Coordinates of 2 Points Method

A scaling method where four numbers are entered manually: low input, desired reading at low input; high input, and desired reading at high input. The meter then applies a straight line fit. The decimal point is set by the separate *dEC.Pt* menu item.

Scaling, Scale and Offset Method

A scaling method where *scale* and *offset* are entered manually.

Scaling, Reading Coordinates of 2 Points Method

A scaling method, where the low and high input values are determined from actual signals. A known low signal is first applied to the meter. That signal is captured as the low input value, and the desired low reading is entered. A known high signal is then applied. That signal is captured as the high input value, and the desired high reading is entered. The meter then applies straight line fit. This scaling method has the advantage of calibrating the transducer and meter as a system. The actual voltage or current at either point does not need to be known. The decimal point is set by the separate *dEC.Pt* menu item.

Setpoint

A value compared to the reading to determine the state of a relay. Term often used interchangeably with “alarm setpoint.” The relay action can be *latching* or *non-latching*, utilize a *hysteresis band*, or utilize a *deviation band*. Hysteresis bands and deviation bands are specified by two symmetrical limits around the *setpoint*.

Span

The number of *counts* corresponding to a given signal range.

Tare

A rear panel input which causes the display to be set to zero when the input is momentarily tied to logic ground by a switch or is held at 0V (logic level true). When the input is allowed to float or is held at +5V (logic level false), the meter displays readings relative to this new zero. A common application is in weighing, where an external Tare button is pressed to read the weight of an empty scale (tare), and tare is then automatically subtracted as a constant from gross weight for display of net weight. Tare can also be used for other applications where a reading relative to starting point is desired.

Valley Display

The minimum (or most negative) reading since that minimum was last reset. Reset can be via the meter front panel, an external input, or a software command. The displayed value can reflect the filtered or unfiltered readings.

Zero

When used with process meters, *zero* is an adjustment so that a given low transducer output reads zero on the meter. *Zero* is adjusted by programming *offset*.

25. WARRANTY

Laurel Electronics Inc. warrants its products against defects in materials or workmanship for a period of one year from the date of purchase.

In the event of a defect during the warranty period, the defective unit may be returned to the seller, which may be Laurel or a Laurel distributor. The seller may then repair or replace the defective unit at its option. In the event of such a return, freight charges from the buyer shall be paid by the buyer, and freight charges from the seller shall be paid by the seller.

LIMITATION OF WARRANTY

The foregoing warranty shall not apply to defects resulting from:

1. Improper installation or miswiring.
2. Improper or inadequate maintenance.
3. Unauthorized modification or misuse.
4. Operation outside the environmental specifications.
5. Mishandling or abuse.

The warranty set forth above is exclusive, and no other warranty, whether written or oral, is expressed or implied. Laurel specifically disclaims implied warranties of merchantability and fitness for a particular purpose.

Any electronic product may fail or malfunction over time. To minimize risks associated with reliance on Laurel products, users are expected to provide adequate system-level design and operating safeguards. Laurel's products are intended for general purpose industrial or laboratory use. They are not intended nor certified for use in life-critical medical, nuclear, or aerospace applications, or for use in hazardous locations.

EXCLUSIVE REMEDIES

The remedies provided herein are Buyer's sole and exclusive remedies. In no event shall Laurel be liable for direct, indirect, incidental or consequential damages (including loss of profits) whether based on contract, tort, or any other legal theory.