

## Instruction Manual

---

# HI 98703 Portable Turbidimeter



Dear Customer,

Thank you for choosing a Hanna Instruments product.

Please read this instruction manual carefully before using this instrument.

This manual will provide you with the necessary information for correct use of this instrument, as well as a precise idea of its versatility.

## WARRANTY

HI 98703 is guaranteed for two years against defects in workmanship and materials when used for its intended purpose and maintained according to instructions. This warranty is limited to repair or replacement free of charge.

Damage due to accidents, misuse, tampering or lack of prescribed maintenance is not covered.

If service is required, contact the dealer from whom you purchased the instrument. If under warranty, report the model number, date of purchase, serial number and the nature of the problem. If the repair is not covered by the warranty, you will be notified of the charges incurred. If the instrument is to be returned to Hanna Instruments, first obtain a Returned Goods Authorization number from the Technical Service department and then send it with shipping costs prepaid. When shipping any instrument, make sure it is properly packed for complete protection.

To validate your warranty, fill out and return the enclosed warranty card within 14 days from the date of purchase.

## TABLE OF CONTENTS

WARRANTY .....	2
PRELIMINARY EXAMINATION .....	3
GENERAL DESCRIPTION .....	4
TAG IDENTIFICATION SYSTEM .....	5
ABBREVIATIONS .....	5
PRINCIPLE OF OPERATION .....	6
MEASUREMENT UNITS .....	7
FUNCTIONAL DESCRIPTION .....	8
SPECIFICATIONS .....	11
GENERAL TIPS FOR AN ACCURATE MEASUREMENT .....	12
MEASUREMENT PROCEDURE .....	19
CALIBRATION PROCEDURE .....	22
LOGGING .....	26
GOOD LABORATORY PRACTICE (GLP) .....	29
SETUP .....	31
LCD BACKLIGHT .....	35
TAG INSTALLATION .....	35
LAMP REPLACEMENT .....	36
BATTERIES MANAGEMENT .....	36
PC INTERFACE .....	38
ERROR CODES .....	38
ACCESSORIES .....	39

## PRELIMINARY EXAMINATION

Please examine this product carefully. Make sure that the instrument is not damaged. If any damage occurred during shipment, please notify your local Hanna Office.

Each HI 98703 Portable Turbidimeter is supplied complete with:

- Five Sample Cuvettes and Caps
- Calibration Cuvettes (HI 98703-11)
- Silicone Oil (HI 93703-58)
- Tissue for wiping the cuvettes
- Five Tag holders with Tags (HI 920005)
- Batteries (4 pcs.)
- AC Adapter
- Instruction Manual
- Instrument Quality Certificate
- Rigid carrying case

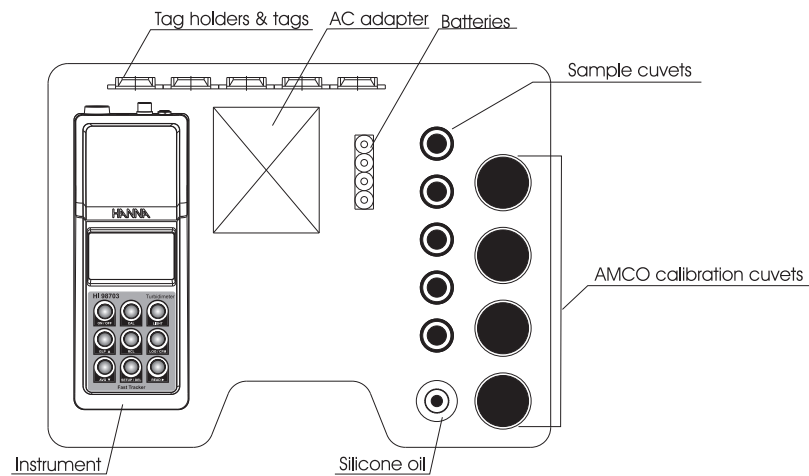

**Note:** Save all packing material until you are sure that the instrument functions correctly. Any defective item must be returned in its original packing with the supplied accessories.

*All rights are reserved. Reproduction in whole or in part is prohibited without the written consent of the*

## GENERAL DESCRIPTION

**HI 98703** is a high accuracy EPA compliant portable turbidimeter that benefits from Hanna's years of experience as manufacturer of analytical instruments. The **HI 98703** meets and exceeds the requirements of the **USEPA Method 180.1** for wastewater and **Standard Method 2130 B** for drinking water.

The instrument is specially designed for water quality measurements, providing a reliable and accurate reading on low turbidity values.

The **HI 98703** instrument measures the turbidity of a sample in the 0.00 to 1000 NTU (Nephelometric Turbidity Units) range. An effective algorithm calculates and converts the readings in NTU.

The instrument has an EPA compliance reading mode which rounds the reading to meet EPA reporting requirements.

Depending on the measured probe and needed accuracy, normal measurement, continuous measurement, or signal averaging measurement can be selected.

The instrument is based on a state-of-the-art optical system, which guarantees accurate results. The optical system, consisting in a tungsten filament lamp and two detectors (scattered and transmitted), assures long term stability and minimizes stray light and color interferences. It also compensates for variations in intensity of the lamp, minimizing the need of frequent calibration.

The 25 mm round cuvettes made from special optical glass guarantee the repeatability and consistency of the measurements.

Calibration can be easily performed at any time in two, three or four points (<0.1, 15, 100 and 750 NTU-adjustable calibration points), using the supplied or user prepared standards.

**HI 98703** has complete GLP (Good Laboratory Practice) functions that allows traceability of the calibration conditions. The last calibration points, time and date can be checked at any time by a single touch.

**HI 98703** has a very user-friendly interface, with an easy to read, large LCD (Liquid Crystal Display). The displayed codes guide the user step by step with routine operation and through calibration. Confirmation and acoustic signals help the user during instrument operation.

The **HI 98703** turbidimeter is a truly splash proof portable instrument. It is supplied with a rigid carrying case that offers protection for harsh environments.

One battery set is enough for at least 1500 measurements. The battery charging percentage and low battery condition are displayed on the LCD to avoid unexpected battery failure. In order to save the battery life, the instrument has an auto shut-off feature and will turn off after 15 minutes of non-use. In addition, the instrument is equipped with backlight and the current time is continuously displayed on the LCD.

The instrument also provides a logging function. Up to 200 measurements can be stored in the internal memory and consulted at any time. Data can be downloaded to a PC for storing or further analysis through one of the two available ports: RS232 or USB.

For advanced field applications, the **HI 98703** turbidimeter is equipped with Tag Identification System (TIS) that makes data collecting and management simpler than ever.

## TAG IDENTIFICATION SYSTEM

Hanna is the first manufacturer of turbidity instruments that has decided to add the unique T.I.S. - Tag Identification System to our Portable Turbidimeters, to meet the more restrictive needs of the users and fit all advantages of this system to the turbidity measurements and data management.

The system is designed for scientific and industrial applications, or to prove during safety audits and inspections that samples have been truly taken on pre-established locations.

The system is as easy to install as to operate. Just fix the so-called iButton® tags near your sampling sites that need to be checked often, and with this the T.I.S. is setup. The tag contains a computer chip embedded in a durable stainless steel can. It is designed to withstand the harsh environments, indoors or outdoors. The number of tags that can be installed is practically unlimited, because each tag has a unique identification code.

Immediately after tags installation you can start collecting data. Use the Portable Turbidimeter to take measurements and memorize the test result by pressing the Log-on-Demand key. Then, the instrument will ask for the tag identification. Simply touching the iButton® with the matching connector on the Portable Turbidimeter does identify and authenticate logging, by storing the iButton® serial number, time and date stamp.

The power of the T.I.S. features resides in the PC application. Download all test data to your PC and use our **HI 92000** Windows® compatible application software for further data management. You can sort or filter all your collected test data on different criteria like on a specific sampling location, parameter, date and time intervals, or fix range to filter measured values. The data can be plotted in a graph, exported to other common Windows® applications or printed for reporting purpose.

It is also possible to add new tags later on, thus increasing an already existing database. Each time the PC software recognizes a new added tag, it will ask for a description of the new sampling location.

## ABBREVIATIONS

NTU	Nephelometric Turbidity Units
JTU	Jackson Turbidity Units
FTU	Formazin Turbidity Units
USEPA	US Environmental Protection Agency
LCD	Liquid Crystal Display
RTC	Real Time Clock
RH	Relative Humidity
TIS	Tag Identification System
ID	Identification

iButton® is registered Trademark of "MAXIM/DALLAS semiconductor Corp."

## PRINCIPLE OF OPERATION

Turbidity of the water is an optical property that causes light to be scattered and absorbed, rather than transmitted. The scattering of the light that passes through a liquid is primarily caused by the suspended solids. The higher the turbidity, the greater the amount of scattered light. Because even the molecules in a very pure fluid scatter light to a certain degree, no solution will have zero turbidity.

The **USEPA Method 180.1** specify the key parameters for the optical system to measure turbidity for drinking, saline and surface water in a 0 to 40 NTU range, using the nephelometric method.

The **HI 98703** Portable Turbidimeter is designed to meet or exceed the criteria specified by the **USEPA Method 180.1** and **Standard Method 2130 B**.

The light beam that passes through the sample is scattered in all directions. The intensity and pattern of the scattered light is affected by many variables like wavelength of the incident light, particle size, shape, refractive index and color.

The Hanna's **HI 98703** is based on a state-of-the-art optical system that guarantee both high performance and reliable results.

This optical system includes a tungsten filament lamp, a scattered light detector ( $90^\circ$ ) and a transmitted light detector ( $180^\circ$ ). The microprocessor of the instrument calculates from the signals that reaches the two detectors, the NTU value, using an effective algorithm. This algorithm corrects and compensates for interferences of color, making the **HI 98703** turbidimeter color-compensated.

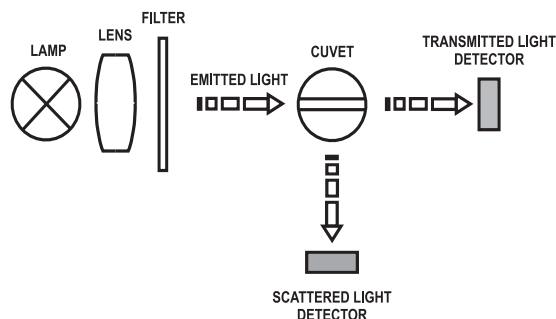

The optical system and measuring technique allow the compensation of lamp intensity fluctuations, minimizing the need of frequent calibration.

The lower detection limit of a turbidimeter is determined by the so called "stray light". Stray light is the light detected by the sensors, that is not caused by light scattering from suspended particles. The optical system of **HI 98703** turbidimeter is designed to have very low stray light, providing accurate results for low turbidity samples. However, special care must be taken when measuring low turbidities (see General Tips for an Accurate Measurement for sample preparation and measuring techniques).

## MEASUREMENT UNITS

Many methods were used to measure turbidity over the years. The Jackson Candle Turbidimeter was used to measure turbidity as Jackson turbidity units (JTU). The Secchi Disk is commonly used to measure turbidity in lakes and other deep waters (mg/L SiO<sub>2</sub>). Both methods are visual and are not considered very accurate. To obtain more accurate readings a nephelometer should be used as a turbidity reading instrument.

The **HI 98703** turbidimeter reports the measurements only in NTU (Nephelometric Turbidity Units). NTU units are equal to FTU units (Formazine Turbidity Units). The conversion table between these measurement units is shown bellow:

	JTU	NTU/FTU	SiO <sub>2</sub> (mg/L)
JTU	1	19	2.50
NTU/FTU	0.053	1	0.13
SiO <sub>2</sub> (mg/L)	0.4	7.5	1

## FUNCTIONAL DESCRIPTION

### INSTRUMENT DESCRIPTION

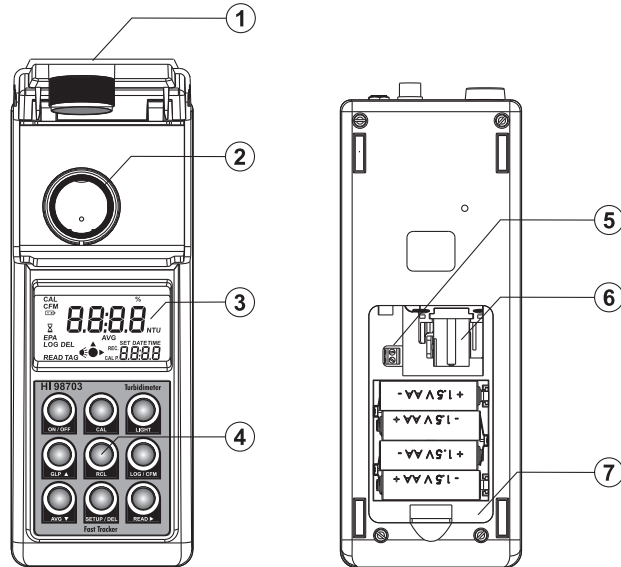

- 1) Cuvette Lid. Close the cuvette lid prior to start a measurement.
- 2) Cuvette Holder. Insert the cuvette into the holder with the cuvette mark matching the case mark.
- 3) Liquid Crystal Display (LCD). The LCD has backlight for better visibility in dark environments.
- 4) Keypad. Splash proof resistant.
- 5) Lamp connector. Connect the new lamp using a screwdriver during lamp changing procedure.
- 6) Lamp. Replacable tungsten lamp.
- 7) Battery Lid. Remove the battery lid in order to change batteries or replace the lamp.

### KEYPAD DESCRIPTION

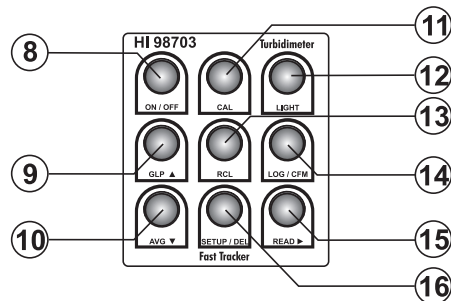



- 8) **ON/OFF**, press to turn the instrument ON/OFF. If no key is pressed for more than 15 minutes, the instrument automatically shuts off.
- 9) **GLP ▲**, press to enter/exit GLP feature. In SETUP it is used to increase the set values. In Log Recall it is used to select a newer record (scroll up).
- 10) **AVG ▼**, press to set the average reading mode ON/OFF. In SETUP it is used to decrease the set values. In Log Recall it is used to select an older record (scroll down).
- 11) **CAL**, press to enter/exit calibration. During setup it is used to start/stop editing a parameter.
- 12) **LIGHT**, press to turn ON/OFF the backlight.
- 13) **RCL**, press to enter/exit viewing log content.
- 14) **LOG/CFM**, press to save the log records or to confirm the selected option.
- 15) **READ ►**, press to start a measurement. Press and hold, to make a continuous measurement. In Log Recall it is used to see the content of a record. In GLP it is used to see all available informations. In SETUP, during date or time editing, it is used to move the focus on the next setting item.
- 16) **SETUP/DEL**, press to enter/exit setup. The DEL function is available in Log Recall to delete one or all records. In GLP it is used to delete the user calibration.

#### CONNECTORS DESCRIPTION

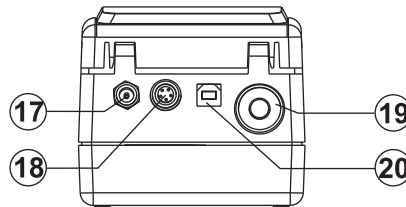

- 17) AC adapter connector, used to connect an external AC Adapter.
- 18) RS232 connector, used to transfer data through the RS232 connection. Use HI 920011 serial cable to connect to the PC.
- 19) Tag reader connector. Touch the tag with the connector to read the location identification number during logging.
- 20) USB connector, used to transfer data to the PC.

## DISPLAY DESCRIPTION

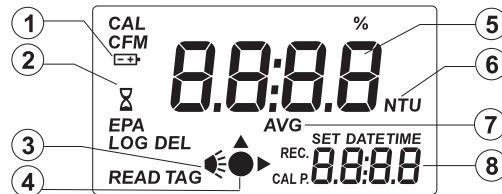

- 1) Battery icon. When it is ON, it shows that the instrument works on battery. When blinking, the batteries are almost empty and need to be replaced.
- 2) Wait icon. It is displayed when the instrument performs an internal checkup.
- 3) Lamp icon. The lamp icon is shown when the lamp is turned on.
- 4) Measurement icon. The icon shows the measuring scheme of the instrument.
- 5) Four digit main display. The main display shows the turbidity value after one measurement. Depending on the instrument working mode, other values or messages are displayed.
- 6) Measurement units. The turbidity is measured in NTU. When average or continuous mode is selected, the "NTU" tag blinks for each new displayed value. For conversions in other units see Measurement Units section.
- 7) AVG icon. When selected, the measurement will be taken in average mode. The "NTU" tag will blink for each new displayed value.
- 8) Four digit secondary display. The secondary display shows the current time (if selected) or other values/messages.

## BEEPER

A beeper is used to make the user interface more friendly. An error or invalid key press is signaled by a long beep. A confirmation beep is signaled by a short beep. The beeper is selectable as ON or OFF in Setup Menu.

## SPECIFICATIONS

<b>Range</b>	0.00 to 9.99 NTU 10.0 to 99.9 NTU 100 to 1000 NTU
<b>Range Selection</b>	Automatically
<b>Resolution</b>	0.01 NTU from 0.00 to 9.99 NTU 0.1 NTU from 10.0 to 99.9 NTU 1 NTU from 100 to 1000 NTU
<b>Accuracy</b>	±2% of reading plus 0.02 NTU
<b>Repeatability</b>	±1% of reading or 0.02 NTU, whichever is greater
<b>Stray Light</b>	< 0.02 NTU
<b>Light Source</b>	Tungsten filament lamp
<b>Lamp Life</b>	Greater than 100,000 readings
<b>Light Detector</b>	Silicon Photocell
<b>Method</b>	Ratio Nephelometric signal (90°) scatter light ratio transmitted light Adaptation of the <b>USEPA Method 180.1</b> and <b>Standard Method 2130 B</b>
<b>Display</b>	60 x 90 mm LCD with backlight
<b>Standards</b>	15, 100 and 750 NTU
<b>Calibration</b>	One, two or three point calibration
<b>LOG Memory</b>	200 records
<b>Serial Interface</b>	RS232 or USB 1.1
<b>Environment</b>	0 to 50 °C (32 to 122 °F); max 95% RH non-condensing
<b>Power supply</b>	4 x 1.5V AA alkaline batteries or AC adapter
<b>Auto Shut-off</b>	After 15 minutes of non-use
<b>Dimensions</b>	224 x 87 x 77 mm (8.8 x 3.4 x 3.0")
<b>Weight</b>	512 g (18 oz.)

## GENERAL TIPS FOR AN ACCURATE MEASUREMENT

HI 98703 is a highly accurate turbidimeter. To meet the instrument performance and fully benefit of its properties it is very important that the analyst perform accurate, precise and repeatable readings using proper measurement techniques. Special care must be taken during sample preparation and handling.

The instructions listed below should be carefully followed during measurement and calibration to ensure best accuracy.

### CUVETTE

The cuvette is part of the optical system in all measurements. The light reaches the sample by passing through the cuvette glass. As a result, the measurement can be affected by the glass imperfections, dirt, dust, scratches, or fingerprints present on the cuvette surface.

### *CUVETTE HANDLING*

The cuvettes should be free of scratches or cracks. Any cuvette with visible scratches will be discarded. The cuvettes should be periodically washed with acid. After washing, the cuvettes should be well rinsed many times with distilled or deionized water. Allow cuvettes to air-dry and store them for long periods of time with caps, to avoid dirt entering inside. Always handle the cuvette by touching only the cap or its top side (over the horizontal line).

Always store the cuvettes in separate boxes or with separators between them to avoid scratches on the surface.

### *CUVETTE PREPARATION*

Whenever a cuvette is used, it must be clean inside and outside. When it is placed into the instrument, it must be dry outside, completely free of fingerprints or dirt.

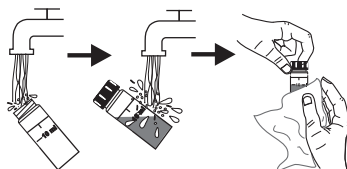

If the cuvette is not indexed, put the cuvette with the factory mark aligned with the sign on the instrument top.

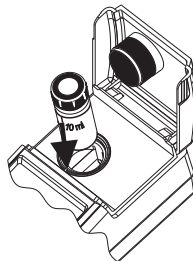

### *CUVETTE OILING*

To hide minor imperfections and scratches, the cuvettes should be oiled outside with the supplied silicone oil. This is very important, especially for low turbidity samples ( $< 1$  NTU), otherwise scratches can contribute and alter turbidity readings.

The silicone oil has the same refractive index as the glass and will not alter the turbidity readings. It is important to apply only a thin layer of silicone oil.

**Warning:** Do not apply the oil in excess, it may retain dirt or contaminate the cuvette holder of the instrument, altering the turbidity readings.

It is very important to apply the silicone oil on a clean, dry cuvette. Apply a few drops of oil and wipe the cuvette thoroughly with a lint-free cloth. Wipe off the excess of oil till you obtain a thin, uniform layer. If the procedure is correctly followed, the cuvette should appear nearly dry with no visible oil.

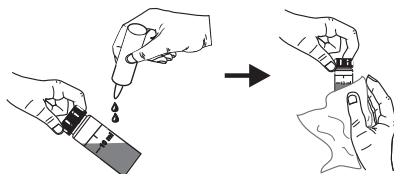

**Note:** The supplied cloth for oiling should be stored together with the silicone oil bottle and cuvettes, taking care to avoid contamination with dirt. After a few oiling procedures the cloth will contain enough oil to wipe the bottle with it without adding more oil. From time to time add some drops of oil on the cuvette to provide the necessary oil quantity in the cloth.

### *INDEXING A CUVETTE*

It is very important for low turbidity readings to always insert the cuvette into the instrument in the same position.

All cuvettes are factory indexed. This index can be used to put the cuvette with the factory mark on the cuvette aligned with the sign on the instrument top.

To further reduce the effect of glass imperfections, the cuvette can be indexed and use this new index as the position mark.

For indexing one cuvette or matching multiple cuvettes the continuous reading mode is suggested. In this mode if **READ ►** is kept pressed, multiple successive readings are taken without turning off the lamp. After first reading is displayed, it is possible to open the cuvette lid and rotate the cuvette without generating an error condition. The turbidity is immediately displayed, reducing drastically the measurement time. The lamp of the instrument will turn off only when **READ ►** is released.

**Note:** The instrument can not perform continuous readings if the average mode is on.

In order to index a cuvette follow the next steps:

- Fill the cuvette with high quality water (<0.1 NTU) up to the line.

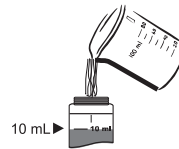

- Clean and oil the cuvette as described before.

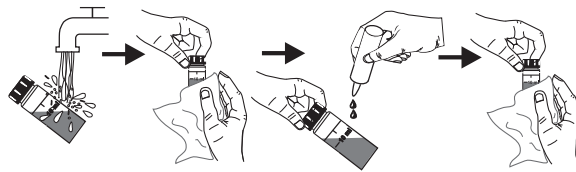

- Turn the instrument ON.



- Insert the cuvette into the instrument and press **READ ►**. Record the reading.

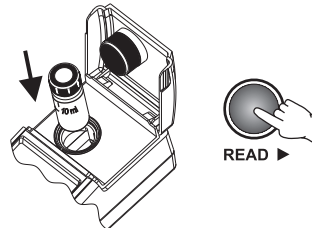

- Open the instrument lid, slightly rotate the cuvette and take a new reading.

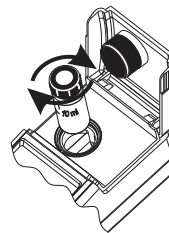

- Repeat the last step until you read the lowest NTU value. Alternatively, keep **READ ►** pressed and, after the first value is displayed, open the lid and start rotating the cuvette until the lowest NTU value is displayed.

- Mark this position on the thicker white band on the top of the cuvette with a water resistant pencil.

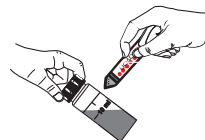

- Always use this position to align it with the sign on the instrument top.

### MATCHING MULTIPLE CUVETTES

Precise measurements require the use of a single cuvette. If it is not possible, the cuvette selection and matching must be performed before taking measurements.

In order to match multiple cuvettes follow the next steps:

- Fill some cuvettes with high quality water (<0.1 NTU) up to the line.

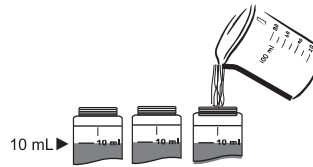

- Clean and oil the cuvettes as described before.

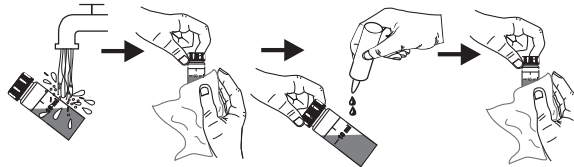

- Turn the instrument ON.



- Insert the first cuvette into the instrument and press **READ** ►. Record the reading.

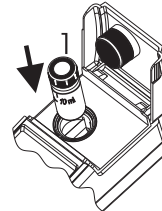

- Record the position of the cuvette and the displayed reading.

- Mark this position on the thicker white band on the top of the cuvette with a water resistant pencil.

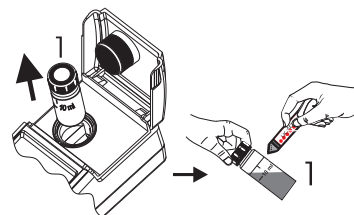

- Insert the second cuvette into the instrument and take a reading.

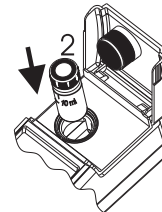

- Open the instrument lid, slightly rotate the cuvette and take a new reading.

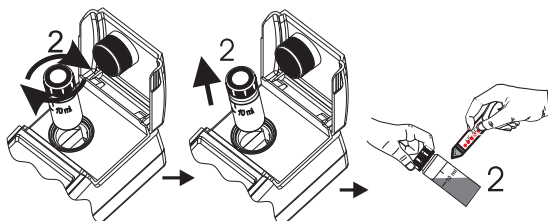

- Repeat the last step for the second cuvette until the reading is within 0.01 NTU of the value obtained for the first cuvette.
- Alternatively, keep **READ ►** pressed and, after the first value is displayed, open the lid and start rotating the cuvette until the displayed value matches the first cuvette.
- Mark this position on the second cuvette with a water resistant pencil.
- Follow the same procedure for all the necessary cuvettes.

**Note:** If the cuvette is indexed, use the index to position it in the instrument.

### SAMPLING TECHNIQUE

When taking turbidity measurements it is very important to select a representative sample. For consistent results, follow the next tips when sampling:

- Gently mix the water before taking the sample.
- If the sample is taken from a pipe, discard the first few liters.
- If measuring a non uniform source, collect samples from different places and mix them.

When measuring the collected sample, keep in mind the following:

- Samples should be analyzed immediately after collection because the turbidity can change in time.
- To avoid dilution of the sample it is better to rinse the cuvette with a quantity of sample and then discard. Only after this you can fill the cuvette with sample.
- Pay attention that cold samples do not condense on the sample cell.

### REMOVING AIR BUBBLES

Any air bubbles present in the sample will cause high turbidity readings. To obtain accurate measurements, remove the air bubbles using one of these methods:

- Application of a partial vacuum;
- Addition of a surfactant, such as Triton X-100;
- Use of an ultrasonic bath;
- Heating the sample.

Sometimes it is necessary to combine two or more methods for efficient air bubble removal.

**Note:** Each method can alter the sample turbidity, if misused, so they have to be used with caution.



#### *APPLICATION OF VACUUM*

Vacuum works by decreasing the atmospheric pressure. In this way the bubbles from the solution came out to the surface.

Application of vacuum is a very simple procedure and can be applied with any vacuum source at hand. The simplest equipment at hand is a syringe and a rubber stopper for vacuum degassing.

- Notes:**
- Pay attention that the vacuum equipment be clean and oil-free.
  - It is not recommended to apply vacuum to a viscous sample that contains volatile components. In such cases the vacuum can determine the volatile component of the viscous sample to increase the bubbles from the sample.

#### *ADDITION OF SURFACTANT*

Surfactant addition works by changing the surface tension of the water. In this way bubbles are released from the sample. This method is effective in samples that are supersaturated with air. The procedure consists in the addition of a drop of surfactant in the cuvette before adding the sample to be analyzed.

A convenient surfactant to use for degassing is Triton X-100.

**Warning:** Pay attention that changing the surface tension will cause a rapid settling of particles that cause turbidity. To avoid this problem, analyze as soon as possible the sample.

Do not shake vigorously the sample because the surfactant may foam. If you are using the same cuvette, rinse it before adding a new sample in order to avoid surfactant accumulation.

Surfactant contribution to the turbidity readings is negligible.

**Note:** Surfactant addition should be used for degassing only when other methods are ineffective.

#### *USE OF AN ULTRASONIC BATH*

The ultrasonic waves are very effective in removing air bubbles from samples. However, ultrasonic waves should be used with care because they can alter sample turbidity characteristics, by modifying the shape and size of particles which cause turbidity. The ultrasonic waves can also break the existing air bubbles, leading to a complication of the degassing process.

In order to avoid excess application of the ultrasonic waves you can apply ultrasound until all visible air bubbles are removed, and then measure the sample turbidity. This is the most used procedure for degassing.

If you are not sure that all air bubbles were removed, apply ultrasonic waves again for a short period of time and then measure the turbidity. Repeat this procedure until the turbidity is increasing instead of decreasing, sign that turbidity of the sample was altered.

In order to degas a sample fill a clean cuvette with sample and immerse it (1/2 to 2/3 immersed) in an ultrasonic bath. Follow the degassing procedure described above. Only after the degassing procedure is finished, the cuvette can be capped.

#### *HEATING THE SAMPLE*

Use of heat to remove air bubbles, although very effective in some cases, should be handled with care because it can alter the turbidity of the sample. When heating a sample, the volatile components from the sample can vaporize, the suspended components can dissolve or the sample characteristics can change.

Therefore, the heating procedure should be used with extreme care.

The best way is to use a warm water bath and immerse the cuvette with sample into the bath. Heat the sample only until the visible bubbles are removed.

**Note:** Always cool the heated sample to the original sample temperature before measurement.

The heating procedure can be used in combination with vacuum or ultrasonic waves application for a more effective air bubble removal.

## MEASUREMENT PROCEDURE

When taking any turbidity measurements several basic rules should be followed:

- Use always cuvettes without scratches or cracks because they can cause inaccurate readings.
- Cap always the cuvettes to avoid spillage of the sample into the instrument.
- Close always the lid of the instrument during measurement.
- Keep the lid of the instrument closed when it is not used to prevent dust or dirt entering.
- Put always the instrument on a flat, rugged surface when taking measurements.
- Do not operate in direct sunlight.
- Do not use too much oil to prevent contamination of the optical system.

To take turbidity measurements, follow the next steps:

- Turn the instrument ON by pressing **ON/OFF**. When dashes are displayed on the LCD, the instrument is ready. On the secondary LCD the current time appears, if selected in SETUP menu.
- Fill a clean, dry cuvette with 10 mL of sample up to the mark, taking care to handle the cuvette by the top.
- Replace the cap.
- Wipe the cuvette thoroughly with a lint-free cloth to remove any fingerprints, dirt or water spots.
- Apply silicone oil on the cuvette and wipe with a lint-free cloth to obtain an even film over the entire surface of the cuvette.

**Note:** It is very important to oil the cuvette, especially for low turbidity values ( $< 1$  NTU) to hide the glass imperfections that can influence the reading.

- Place the cuvette into the instrument. Align the mark from the cuvette with the sign on the instrument case and close the lid.

**Note:** If you have a cuvette with orientation mark, place the cuvette into the instrument with the orientation mark aligned with the sign on the instrument top.

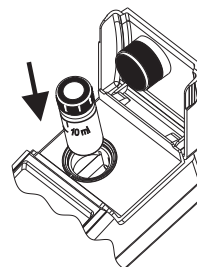
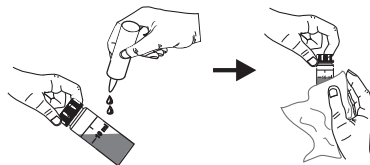
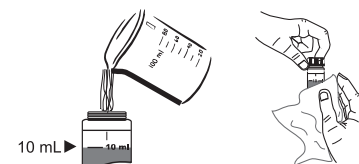
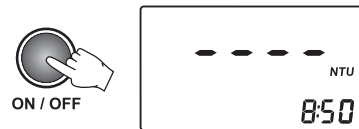

### *NORMAL MEASUREMENT*

This type of measurement can be used for regular measurements, when the sample is stable and normal accuracy is required. In normal measurement mode, the lamp is ON for a minimum period of time (about 7 seconds), saving the battery life. Normal measurement takes about 10 seconds. If normal measurement is selected, the "AVG" tag will not be displayed.

- Press **READ ▶** to start the measurement.  
The display will show blinking dashes and the icons for cuvette, detectors and lamp will appear during measurement.

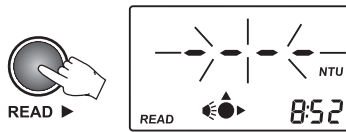

- At the end of the measurement, the instrument directly displays turbidity in NTU.



### *CONTINUOUS MEASUREMENT*

This measurement mode can be used when many measurements have to be taken in a short period of time. The feature is also useful to evaluate a very fast settling sample. This measurement mode is recommended for indexing cuvettes. After the first reading is taken, the lid opening will not generate any errors.

The first value is displayed after about 10 seconds and then a new reading is displayed each second. In order to make a continuous measurement keep **READ ▶** pressed until the desired number of measurements are taken. The display will show blinking dashes and the icons for cuvette, detectors and lamp will appear. When a new value is displayed, the cuvette icon and the measurement unit will briefly blink.

The last value remains on the display after the **READ ▶** is released.

### *AVERAGED MEASUREMENT*

Select this measurement mode when samples that cause unstable readings are analyzed. By averaging several readings, the random noise generated by the sample is reduced and accurate measurements can be taken.

This mode can also be selected when high accuracy measurements are desired. In the average mode 10 measurements are averaged in a short period of time (about 20 seconds). The initial value is displayed after 10 seconds and the display is updated every second with an intermediate value.

- To select the averaged measurement mode press **AVG ▼**. When this mode is selected, the "AVG" icon will be displayed on the LCD.

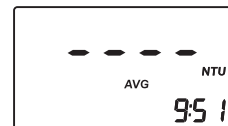

- Press **READ** ► to start the average reading mode. The display will show blinking dashes and the icons for cuvette, detectors and lamp will appear during measurement. When a new partial value is displayed, the cuvette icon and the measurement unit will blink shortly.
- When the measurement is ended, the final averaged result is displayed directly in NTU.

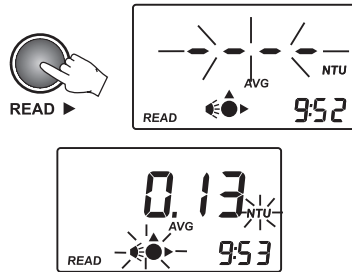

#### RANGE AND UNITS

**HI 98703** automatically selects the correct range to display the results with the highest accuracy. If the measured value is higher than 1000 NTU (over range), the display will show the maximum value blinking.

The instrument has an EPA compliance reading mode. If this feature is activated in **SETUP**, "EPA" tag will appear on the LCD and the readings will be rounded to meet EPA reporting requirements, as shown in the table:

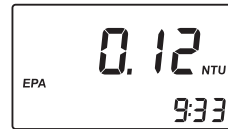

NTU	Record to Nearest
0.0-1.0	0.05
1-10	0.1
10-40	1
40-100	5
100-400	10
400-1000	50
>1000	100

## CALIBRATION PROCEDURE

HI 98703 has a powerful calibration function that compensates for lamp aging or changing. The calibration can be done using the supplied calibration solutions or user prepared standards.

HI 98703 turbidimeter is supplied with 4 AMCO standards: <0.1 NTU, 15 NTU, 100 NTU and 750 NTU. The Hanna standards are specially designed for this instrument. The turbidity standards have a shelf life and should not be used after the expiration date.

Alternatively, formazin standards can be used. It is recommended that the prepared calibration solutions to be close to the default calibration points.

The first point should be near 0 NTU. The second point can be chosen between 10 and 20 NTU, the third point between 50 and 150 NTU and the fourth point between 600 and 900 NTU.

### FORMAZIN PREPARATION

In order to prepare formazin 4000 NTU stock solution, follow the next procedure:

*Solution I*: Dissolve 1.000 grams of hydrazine sulfate,  $(\text{NH}_2)_2\text{H}_2\text{SO}_4$ , in distilled, deionized water and dilute to 100 mL in a volumetric flask.

**Warning:** Handle hydrazine sulfate with care because it is a carcinogen reagent. Avoid inhalation, ingestion, or skin contact. Formazin solution can also contain some hydrazine traces.

*Solution II*: Dissolve 10.000 grams of hexamethylenetetramine,  $(\text{CH}_2)_6\text{N}_4$ , in distilled, deionized water and dilute to 100 mL in a volumetric flask.

*Stock solution* Mix 10 mL Solution I and 10 mL Solution II in a flask. Let the stock solution stays 48 hours at  $25 \pm 3^\circ\text{C}$  ( $77 \pm 5^\circ\text{F}$ ). This will result in a 4000 NTU formazin suspension. It is very important for the formation of the formazin polymer to maintain the same temperature.

The stock solution (4000 NTU) can be stored up to one year in proper conditions. Store formazin in amber glass bottle or any UV-light blocking bottle.

To obtain a high quality formazin always use pure reagents and high-purity water.

To prepare the calibration standards, dilute the stock solution with the same high-purity water you used for the preparation of the stock solution.

The diluted formazin solutions are not stable. They should be used immediately after preparation and discard immediately after use.

If the prepared formazin is used, enter the actual standard value by pressing ▲ or ▼ key to edit the value of the second, third or fourth calibration point.

### CALIBRATION

For best results, the measurement techniques must be followed during calibration. If formazin standards are used, mix the cuvettes gently for about 1 minute and then allow the standard to settle for one more minute before calibration.

Calibration can be performed in two, three or four points. It is possible to interrupt calibration procedure at any time by pressing CAL or ON/OFF.

**TWO-POINT CALIBRATION**

- Turn the instrument on by pressing **ON/OFF**. When the LCD displays dashes, the instrument is ready.
- Enter calibration mode by pressing **CAL**. The display will show "CAL P.1" and no suggested value. This first point is used to check the optical system.
- Place the <0.1 NTU standard cuvette into the holder and ensure that the cuvette mark is aligned with the sign on the instrument top.
- Close the lid and press **READ** ►. The display will show blinking dashes and the icons for cuvette, detectors and lamp will appear during measurement. Alternatively, press **LOG/CFM** to skip the first point.
- The second calibration point (15.0 NTU) is then displayed on the primary LCD, "CAL P.2" on the secondary LCD, and "READ" tag will blink.
- If the prepared formazin is used, edit the displayed value by pressing ▲ or ▼ keys until the display shows the correct value.
- Remove the first standard cuvette and place the 15.0 NTU standard cuvette (or the prepared one) into the holder and ensure that the cuvette mark is aligned with the sign on the instrument top.
- Close the lid and press **READ** ►. The display will show blinking dashes and the icons for cuvette, detectors and lamp will appear during measurement.

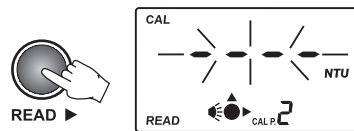
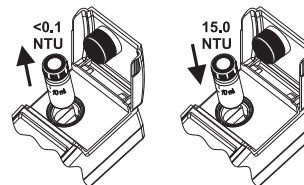
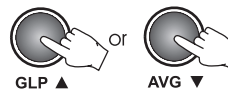
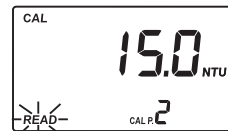
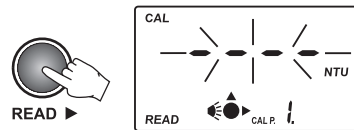
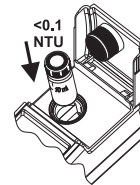
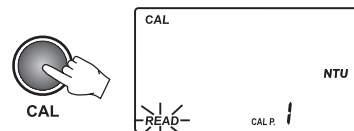
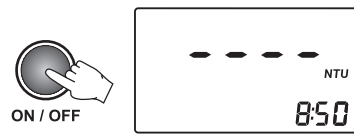

- At the end of the measurement, the third calibration point (100 NTU) is displayed on the primary LCD, "CAL P.3" on the secondary LCD, and "READ" tag will blink.
- At this moment it is possible to exit calibration by pressing **CAL**. The instrument will memorize the two-point calibration data and will return to measurement mode.

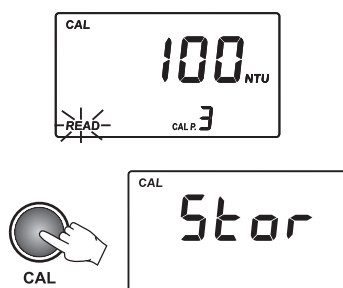

### THREE-POINT CALIBRATION

To perform a three-point calibration, continue the procedure with the following steps:

- Remove the second standard cuvette.
- Place the 100 NTU standard cuvette (or the prepared formazin standard) into the holder, with the cuvette mark aligned with the sign on the instrument.
- Close the lid and press **READ** ►. The display will show blinking dashes and the icons for cuvette, detectors and lamp will appear during measurement.
- At the end of the measurement, the fourth calibration point (750 NTU) is displayed on the primary LCD and "CAL P.4" on the secondary LCD.
- At this moment it is possible to exit calibration by pressing **CAL**. The instrument will memorize the three-point calibration data and will return to measurement mode.

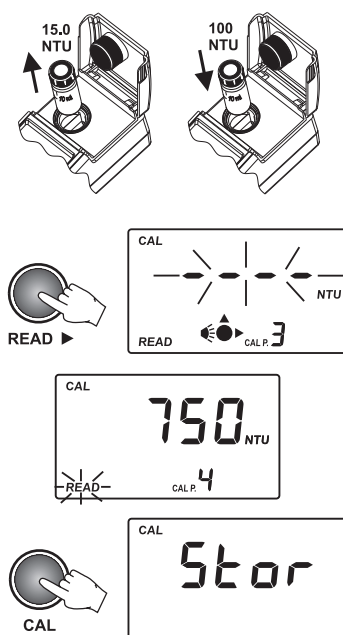

### FOUR-POINT CALIBRATION

To perform a four-point calibration, continue the procedure with the following steps:

- Remove the third standard cuvette.
- Place the 750 NTU standard cuvette (or the prepared formazin standard) into the holder, with the cuvette mark aligned with the sign on the instrument.

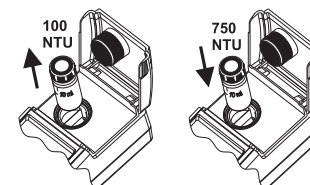



- Close the lid and press **READ ▶**. The display will show blinking dashes and the icons for cuvette, detectors and lamp will appear during measurement.
- At the end of the measurement, the four-point calibration is completed and the instrument returns automatically to measurement mode.

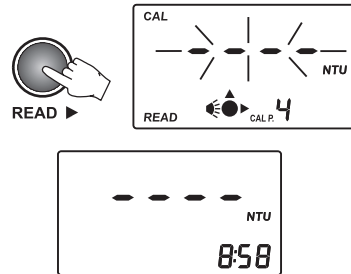

### OUT CAL RANGE FUNCTION

The instrument has an **Out Cal Range** function to prevent taking measurements in a range where the calibration does not assure the best results. The range where the calibration assures correct measurements is up to 40 NTU for two-point calibration and up to 150% of the third point value for three-point calibration.

The display will show a blinking "CAL" tag each time the measurements are taken outside the calibration range.

### CALIBRATION ERRORS

- If the read value during calibration is too far from the set value, the instrument will show "-LO-" or "-HI-" error.
- If the calculated calibration coefficients are outside a certain range, the "CAL Err" message is displayed.

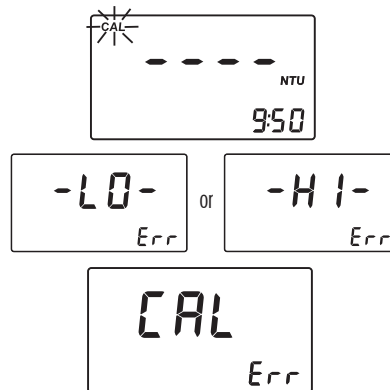

### CALIBRATION DELETION

HI 98703 is factory calibrated. It is possible to restore factory calibration by deleting last performed calibration.

To delete last calibration, follow the next steps:

- Enter the GLP feature by pressing **GLP ▲**. The date of the last calibration will be displayed on the LCD.
- Press **READ ▶** to see the information related to calibration. The last panel is the one with delete calibration.
- Press **SETUP/DEL** to delete the current calibration. After deletion the instrument will automatically return to measurement mode.

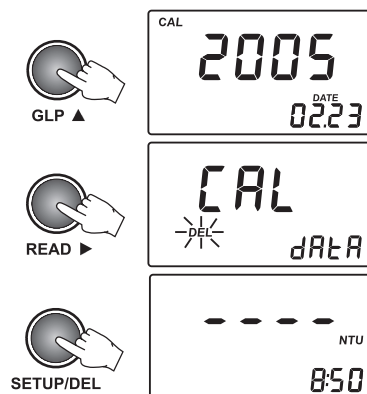

## LOGGING

HI 98703 has a log space for up to 200 records. With each measurement, the date, time and tag ID is stored. In this way, each record is fully characterized and can be easily analyzed when downloading data on the PC application (HI 92000).

### LOGGING

The log function is active after a valid measurement is obtained (no errors).

- To log a value, press **LOG/CFM** when the measurement result is displayed. The instrument asks to “**READ TAG**” for identification of the sampling location. The location for the new record is also displayed on the secondary LCD.
- To read the ID code for the sampling location identification, simply touch the iButton® tag with the matching connector, located on the back of the instrument (see Connectors Description, page 9). Alternatively, press again **LOG/CFM** to store the record without the tag ID code.
- If the tag is successfully read, the instrument will beep once, displaying the unique hexadecimal code of the tag, and store the data. After data is stored, the instrument returns to measurement mode.

- Notes:**
- If the tag is not read within 20 seconds, the logging procedure is canceled.
  - A measurement can be stored only once. Also an over range value can be stored.
  - If less than ten free records are available, the “**LOG**” tag will blink while storing data.
  - If the log memory is full, the “**LoG FULL**” message will appear for a few seconds on the LCD and the instrument will return to measurement mode without storing the new record.

To store a new record, delete one or more records.

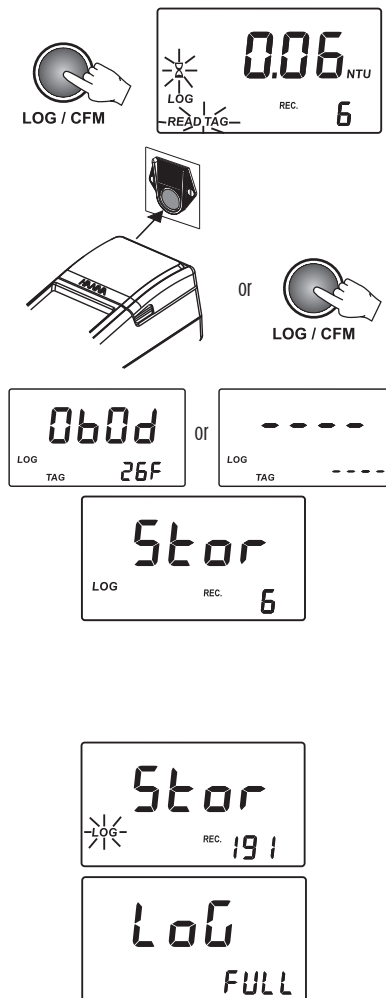

### VIEW LOGGED DATA

The stored records can be viewed at any moment by pressing **RCL**. To return to normal measurement mode, press **RCL** again.

#### *LOG SEARCHING*

The log records are stored in chronological order. The first displayed record is the last stored one.

- Press ▲ or ▼ keys to scroll the log memory record by record. By keeping pressed the ▲ or ▼ keys, the scrolling speed will increase. The scrolling of the log is possible from any panel of the record, except "Delete last log" and "Delete all logs" panels.
- When scrolling the log, the number of the record is displayed for one second on the secondary LCD, together with "TAG" if the identification of the sampling location was made.

When the end of the log is reached, an error beep is heard.

#### *RECORD VIEWING*

Each record contains more information than the measured value. The additional information is grouped in several panels.

Press **READ** ► to scroll through the record panels. The record panels are displayed one by one in a circular way.

Each record contains the following panels:

- The record value (turbidity value) and record number.

**Note:** If the logged sample value is an over range reading, the maximum value (1000) will be displayed blinking.

- The hexadecimal string of the tag for the sampling location ID.

**Note:** If the ID data are missing, dashes are displayed instead.

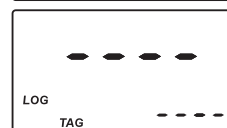

- Measurement date in YYYY.MM.DD format.
- Measurement time in hh:mm format.
- Delete the last record panel (only for last record).
- Delete all records.

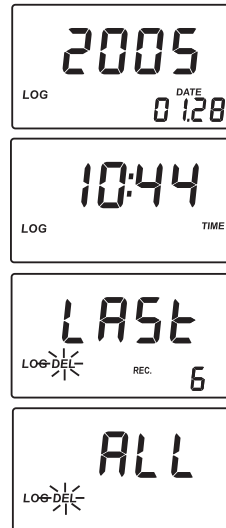

#### DELETE LAST RECORD

To log other values, the last record or all records have to be deleted.

- To delete the last record, press **SETUP/DEL** while in delete last records panel.
- The instrument asks for confirmation and if **LOG/CFM** is pressed, the last record is deleted. To abort the delete function, press **READ** ► instead of **LOG/CFM**.
- After the record is deleted, the instrument goes immediately to the first panel of the previous record. If the log becomes empty, dashes will be displayed for one second and the instrument will return to idle mode.

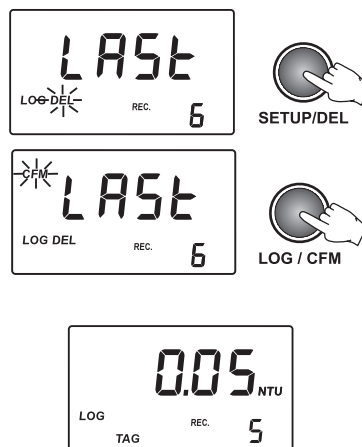

#### DELETE ALL RECORDS

To delete all records, scroll the log until delete all records panel is displayed on the LCD.

- To delete all records press **SETUP/DEL** while in delete all records panel.



- The instrument asks for confirmation and if **LOG/CFM** is pressed, all records are deleted. To abort the delete function, press **READ ▶** instead of **LOG/CFM**.



- After all records are deleted, dashes are displayed for one second and the instrument returns to idle mode.

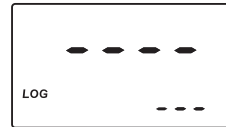

## GOOD LABORATORY PRACTICE (GLP)

The GLP feature allows the user to view last calibration data. Also, the user calibration can be deleted.

Press **GLP ▲** to enter or exit GLP data consulting. Several functions are available when in GLP menu.



Press **READ ▶** to scroll the following GLP data:



- The last calibration date, in YYYY.MM.DD format. If no calibration was performed, the factory calibration message, "FCAL", will be displayed on the LCD.



- The time of the last calibration in hh:mm format.



- First calibration point: 0.00 NTU if skipped or the actual read value (e.g. 0.01 NTU).

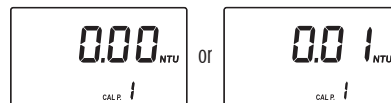

- Second calibration point.



- Third calibration point (if available).



- Fourth calibration point (if available).

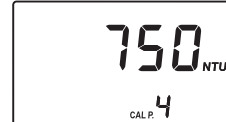

- Delete calibration panel.

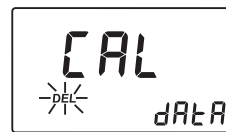

To delete calibration:

- Press **SETUP/DEL** while in the delete calibration panel of the GLP. The user calibration will be deleted and the factory calibration will be restored. The instrument will enter automatically in idle mode.



## SETUP

Setup mode allows viewing and modifying the instrument parameters. The blinking "CAL" tag during setup mode suggest to press CAL for parameters editing.

- To enter/exit SETUP, press SETUP/DEL.



- To select the parameter to be edit, press ▲ or ▼ keys until the desired panel is displayed.



### SET EPA COMPLIANCE MODE

When EPA compliance reading is ON, "EPA" message is displayed on the secondary LCD and the reported values are rounded to meet EPA reporting requirements.

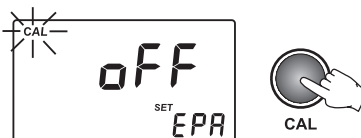

- To edit the EPA mode, press CAL when "EPA" compliance reading panel is displayed. The parameter setting and "CFM" tag will start blinking.

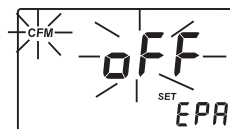

- Press the ▲ or ▼ keys to set ON or OFF the EPA compliance mode.



- Press LOG/CFM to save the setting. The new selected option of the parameter will be displayed on the LCD. Alternatively, press CAL to exit without saving the new settings.



### SET BEEPER

The HI 98703 has a built-in beeper that signals the tag read, the key press and the error conditions. The beeper can be selected to be ON or OFF.

- To set the beeper ON/OFF, press CAL when set beeper panel is displayed. The beeper status and "CFM" tag will start blinking.

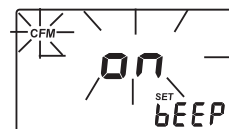

- Press the ▲ or ▼ keys to set the beeper ON/OFF.

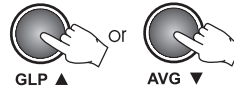

- Press LOG/CFM to save the change. The new selected option will be displayed on the LCD. Alternatively, press CAL to exit without saving the changes.

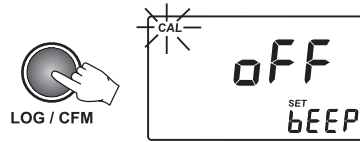

### SHOW / HIDE THE TIME

You can choose between showing or hiding the current hour and minutes on the LCD.

- To set hiding or showing the time, press CAL when show/hide time panel is displayed. The time show status and "CFM" tag will start blinking.

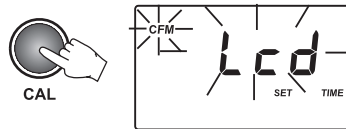

- Press the ▲ or ▼ keys to set lcd / hide for time.



- Press LOG/CFM to save the change. The new selected option will be displayed on the LCD. Alternatively, press CAL to exit without saving the changes.

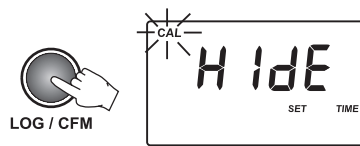

### SET THE DATE

The HI 98703 turbidimeter has a built-in real time clock (RTC). The RTC time is used to generate a unique time stamp for each recorded value and to automatically store the last calibration date. The current time can be displayed on the LCD when the instrument is in idle mode.

- To set the current date, press CAL when set date panel is displayed. The date format is YYYY.MM.DD. The last two digits of the year value and "CFM" tag will start blinking.

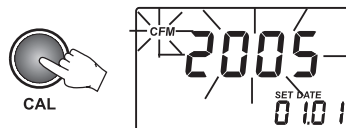

- Press the ▲ or ▼ keys to set the year value.





- Press **LOG/CFM** or **READ ▶** to start editing the month value. The month value will start blinking.

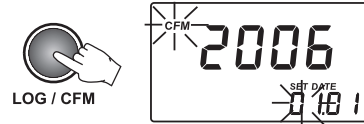

- Press the **▲** or **▼** keys to set the month value.

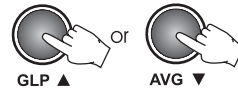

- Press **LOG/CFM** or **READ ▶** to start editing the day value. The day value will start blinking.

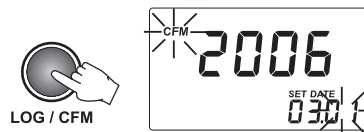

- Press the **▲** or **▼** keys to set the day value.

**Note:** To edit the year again, after the day was set, press **READ ▶**.



- Press **LOG/CFM** to save the new date. The new date will be displayed on the LCD. Alternatively, press **CAL** to exit without saving the changes.

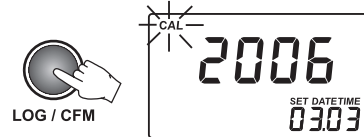

### SET THE TIME

- To set the current time, press **CAL** when set time panel is displayed. The time format is hh:mm. The hour value and "CFM" tag will start blinking.

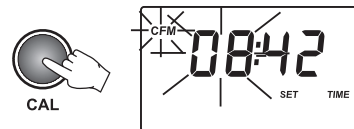

- Press the **▲** or **▼** keys to set the hour value.



- Press **LOG/CFM** or **READ ▶** to start editing the minutes. The minutes value will start blinking.

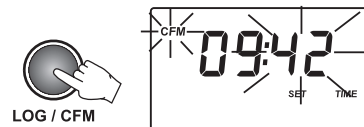

- Press the **▲** or **▼** keys to set the minutes value.

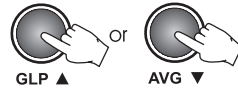

**Note:** To edit the hour again, after the minutes were edited, press **READ ▶**.

- Press **LOG/CFM** to save the new time. The new set time will be displayed. Alternatively, press **CAL** to exit without saving the changes.

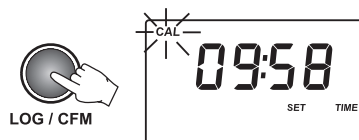

### SET INSTRUMENT ID

The instrument ID is a four digit number that can be edited by the user. The instrument ID is downloaded on the PC application, together with the logged data. By setting a different ID for each instrument it is possible to mix information from many turbidimeters into the same database.

- To set the instrument ID, press **CAL** when set instrument ID panel is displayed. The default instrument ID is 0000. The existing ID value and “CFM” tag will start blinking.



- Press the **▲** or **▼** keys to set the new instrument ID. By pressing and holding the **▲** or **▼** keys, the changing speed will increase.



- Press **LOG/CFM** to save the change. The new instrument ID will be displayed. Alternatively, press **CAL** to exit without saving the changes.

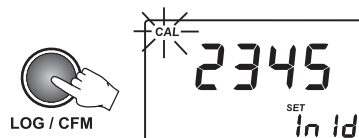

### SET BAUD RATE

The **HI 98703** has a RS232 and a USB link. When the USB connection is used, the RS232 connection becomes inactive.

To successfully communicate with the PC, the same baud rate must be selected on the instrument and on the PC application. The available baud rates are 1200, 2400, 4800 and 9600.

- To set the baud rate, press **CAL** when set baud rate panel is displayed. The parameter value and “CFM” tag will start blinking.

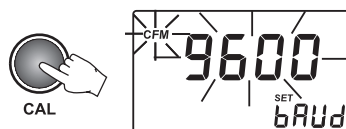

- Press the ▲ or ▼ keys to select the new baud rate value.

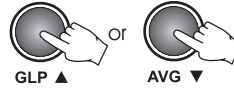

- Press LOG/CFM to save the change. The new selected baud rate will be displayed. Alternatively, press CAL to exit without saving the changes.

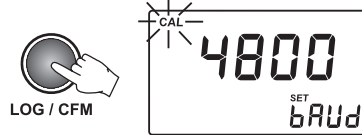

## LCD BACKLIGHT

The LCD can be illuminated to allow the user to see the readings even in dark environments.

To turn ON or OFF the backlight, press LIGHT.

The backlight will automatically shut-off after 25 seconds of non-use to save the battery life.



## TAG INSTALLATION

The tag is housed in a rugged metal that can withstand harsh environments. However, it is better to protect the tag from direct rain.

Place the tag near a sampling point. Fix it securely with the provided screws, in such a way that the metallic iButton® is easily accessible for reading the tag.

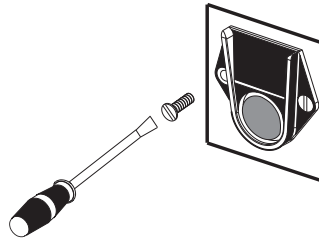

The number of tags that can be installed is practically unlimited. Additional tags can be ordered (HI 920005 - five tag holders with tags).

## LAMP REPLACEMENT

The instrument tungsten lamp has a life longer than 100,000 measurements. In case of lamp failure, the defective lamp can be easily replaced. When the lamp is broken, the instrument displays “no L” error message.

To replace the lamp follow the next steps:

- Remove the battery lid.
- Unscrew the lamp connection using a screwdriver.
- Unlock the lamp and extract it by pulling it out from the lamp holder handler.
- Place the new lamp in the right position and push it until is securely locked.
- Insert the lamp leads into the connector and tight them using a screwdriver.

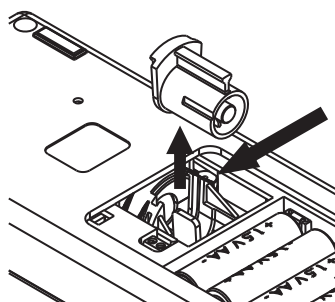

**Warning:** After lamp replacement the meter needs to be recalibrated.

## BATTERIES MANAGEMENT

For field measurements, **HI 98703** is powered by 4 AA batteries. The battery life is enough for 1500 normal measurements.

When the instrument is started, the remaining battery life is estimated and reported in percents.

To preserve the battery it is better to use normal instead of averaged measurements.

Continuous measurements keep the lamp on and should be used with caution if the battery life is an issue.

To further save the battery life, the instrument will turn off after 15 minutes of non-use. The backlight will be turn off after 25 seconds since the last key was pressed.

The battery life is measured each time the lamp is turned on and if the remaining battery life is less than 10%, the battery tag will be displayed blinking on the LCD to warn the user that the batteries need to be replaced.

When the batteries are completely discharged, “0% bAtt” message will be displayed for one second and the instrument will turn off.

In order to use the instrument again, replace the batteries with new ones or use an AC adapter.

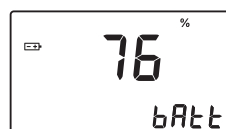

## BATTERIES REPLACEMENT

To replace the batteries follow the next steps:

- Press **ON/OFF** to turn OFF the instrument.
- Open the batteries cover by pressing the locking clip.

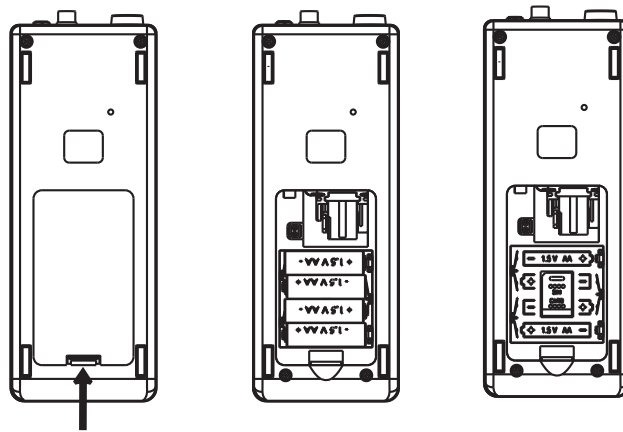

- Take out the used batteries and insert 4 new 1.5 AA size batteries, while paying attention to the correct polarity as indicated on the battery compartment.
- Replace the cover and press it until it locks.
- Turn the instrument ON.

**Warning:** Replace batteries only in a non-hazardous area.

## USING AN AC ADAPTER

The HI 98703 can be powered from the AC adapter when used in laboratory. See the Accessories section to select the correct AC adapter.

To power the instrument, simply connect the AC adapter to the instrument (see Connectors Description, page 9).

It is not necessary to turn the instrument off when connecting the external adapter.

**Note:** The connection to the external adapter will not recharge the batteries.

## PC INTERFACE

To fully use the instrument tag identification system function, the measured data has to be downloaded to a computer. The instrument can use RS232 or USB connection to communicate with the PC.

When using the RS232 protocol, simply connect a **HI 920011** serial cable between the instrument and the computer.

To use the USB protocol, simply connect a regular USB cable between instrument and PC.

In both cases, the PC must run the **HI 92000** application for successful data transfer.

## ERROR CODES

**HI 98703** has a powerful diagnostic system. The common errors are detected and reported for easy diagnostic and maintenance.

ERROR	DESCRIPTION	ACTION
Err1 – Err3; Err6; Err7; Err8	Critical errors. The instrument beeps and shuts down.	Call Hanna service
Err4	The instrument beeps shortly twice and shuts down after 10 seconds.	Press simultaneously UP and DOWN to reset the EEPROM contents.
CAP	The lid is not closed.	Close the lid. If the error persists, return the instrument.
no L	Lamp broken or no light.	Replace the lamp. Check the optical system for obstructions.
L Lo	Not enough light.	Check the optical system for obstructions.
-LO-	The standard used for current calibration point is too low.	Check the standard and use the correct one.
-HI-	The standard used for current calibration point is too high.	Check the standard and use the correct one.
Battery tag blinking	The remaining battery life is too low.	Replace batteries.
bAtt	The batteries are too discharged for correct measurements.	Replace batteries.

## ACCESSORIES

HI 710005	Voltage adapter from 115V to 12 Vdc (USA plug)
HI 710006	Voltage adapter from 230V to 12 Vdc (European plug)
HI 710012	Voltage adapter from 240V to 12 Vdc (UK plug)
HI 710013	Voltage adapter from 230V to 12 Vdc (South Africa plug)
HI 710014	Voltage adapter from 230V to 12 Vdc (Australia plug)
HI 731318	Tissue for wiping cuvettes (4 pcs.)
HI 731331N	Glass cuvettes (4 pcs.)
HI 731335N	Caps for cuvettes (4 pcs.)
HI 740027P	1.5V AA battery (12 pcs.)
HI 740234	Replacement lamp for EPA turbidimeter (1 pc.)
HI 92000	Windows® compatible software
HI 920005	5 tag holders with tags
HI 920011	5 to 9 pins RS232 connection cable
HI 93703-50	Cuvettes cleaning solution (230 mL)
HI 98703-58	Silicon oil (15 mL)

## RECOMMENDATIONS FOR USERS

Before using this product, make sure that it is entirely suitable for your specific application and for the environment in which it is used.

Operation of this instrument may cause unacceptable interferences to other electronic equipment, requiring the user to follow all necessary steps to correct interferences.

Any variation introduced by the user to the supplied equipment may degrade the instrument's EMC performance.

To avoid damage or burns, do not put the instrument in microwave ovens. For your own and the instrument safety do not use or store the instrument in hazardous environments.

Hanna Instruments reserves the right to modify the design, construction or appearance of its products without advance notice.