

Instruction Manual

HI 98120 Waterproof ORP & Temperature Meter

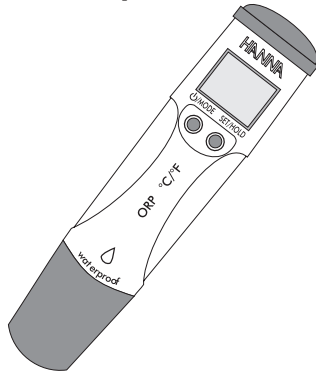

WARRANTY

HI 98120 is warranted for one year against defects in workmanship and materials when used for its intended purpose and maintained according to instructions. The electrode is warranted for a period of six months. This warranty is limited to repair or replacement free of charge.

Damages due to accidents, misuse, tampering or lack of prescribed maintenance are not covered.

If service is required, contact the dealer from whom you purchased the instrument. If under warranty, report the model number, date of purchase, serial number and the nature of the failure. If the repair is not covered by the warranty, you will be notified of the charges incurred. If the instrument is to be returned to Hanna Instruments, first obtain a Returned Goods Authorization Number from the Customer Service department and then send it with shipment costs prepaid. When shipping any instrument, make sure it is properly packaged for complete protection.

All rights are reserved. Reproduction in whole or in part is prohibited without the written consent of the copyright owner.

Hanna Instruments reserves the right to modify the design, construction and appearance of its products without advance notice.

Dear Customer,

Thank you for choosing a Hanna product. This manual will provide you with the necessary information for correct operation. Please read it carefully before using the meter. If you need additional technical information, do not hesitate to e-mail us at tech@hannainst.com.

This instrument is in compliance with the CE directives.

PRELIMINARY EXAMINATION

Remove the instrument from the packing material and examine it carefully. If any damage has occurred during shipment, immediately notify your Dealer or the nearest Hanna Customer Service Center.

Each meter is supplied with:

- HI 73120 ORP electrode
- HI 73128 Electrode removal tool
- 4 x 1.5V batteries

Note: Conserve all packing material until the instrument has been observed to function correctly. Any defective item must be returned in its original packing.

US DESIGN PATENT
D462,024

GENERAL DESCRIPTION

HI 98120 is a waterproof ORP and temperature meter. The housing has been completely sealed against humidity and designed to float.

The temperature values can be displayed in °C or °F units.

The meter is factory calibrated and measurements are highly accurate with a unique stability indicator right on the LCD.

This meter is also provided with battery level indication at start-up, and with a low battery symbol which warns the user when the batteries need to be replaced. In addition the Battery Error Prevention System (BEPS) avoids erroneous reading caused by low voltage level by turning the meter off.

The HI 73120 ORP electrode, supplied with the meter, is interchangeable and can be easily replaced by the user.

The stainless steel encapsulated temperature sensor facilitates faster and more accurate temperature measurement.

FUNCTIONAL DESCRIPTION

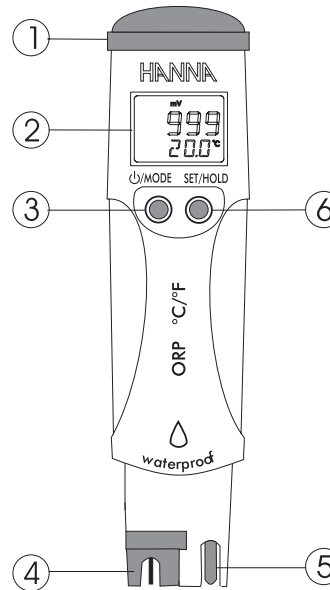

1. Battery compartment
2. Liquid Crystal Display (LCD)
3. ON/OFF/MODE button
4. HI 73120 ORP electrode
5. Temperature sensor
6. SET/HOLD button

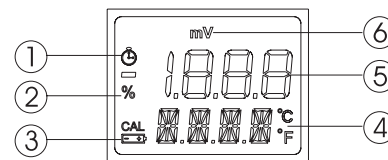

1. Stability indicator
2. Battery life percentage indicator
3. Low battery indicator
4. Secondary display
5. Primary display
6. Measuring unit for primary display

CE DECLARATION OF CONFORMITY

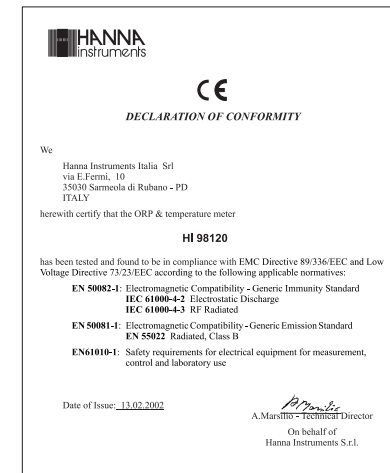

Recommendations for Users

Before using this product, make sure that it is entirely suitable for the environment in which it is used.

Avoid touching the electrode at all times.

Any variation introduced by the user to the supplied equipment may degrade the instrument's EMC performance.

To avoid electrical shock, do not use this instrument when voltages at the measurement surface exceed 24 VAC or 60 VDC. To avoid damages or burns, do not perform any measurement in microwave ovens.

SPECIFICATIONS

Range	± 1000 mV -5.0 to 60.0°C/23.0 to 140.0°F
Resolution	1 mV 0.1°C / 0.1°F
Accuracy (@20°C/68°F)	±2 mV ±0.5°C / ±1°F
Typical EMC	±2 mV
Deviation	±0.3°C / ±0.6°F
Calibration	Factory calibrated
Environment	5 to 50°C (23 to 122°F); RH 100%
Electrode	HI 73120 ORP electrode (included)
Battery Type	4 x 1.5V
Battery Life	Approx. 300 hours of use
Auto-off	After 8 minutes
Dimensions	163 x 40 x 26 mm (6.4 x 1.6 x 1.0")
Weight	100 g (3.5 oz)

OPERATIONAL GUIDE

To turn the meter on and to check battery status

Press and hold the ϕ /MODE button until the LCD lights up. All the used segments on the LCD will be visible for 1 second (or as long as the button is pressed), followed by the percent indication of the remaining battery life (E.g. % 100 BATT).

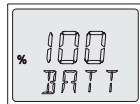

Taking measurements

Submerge the electrode in the solution to be tested while stirring it gently. The measurements should be taken when the stability symbol \square on the top left of the LCD disappears.

The ORP (mV) value is shown on the primary LCD while the secondary LCD shows the temperature of the sample.

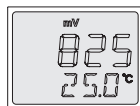

To freeze the display

While in measurement mode, press the SET/HOLD button. HOLD appears on the secondary display and the reading will be frozen on the LCD (E.g. mV 825 HOLD).



Press any button to return to normal mode.

To turn the meter off

While in normal measuring mode, press the ϕ /MODE button. OFF will appear on the secondary display. Release the button.

Note:

If measurements are taken in different samples successively, rinse the probe thoroughly to eliminate cross-contamination; and after cleaning, rinse the probe with some of the sample to be measured.

SETUP

Setup mode allows the selection of temperature unit.

To enter the Setup mode, $^{\circ}\text{C}/^{\circ}\text{F}$ selection, press the ϕ /MODE button until TEMP and the current temperature unit are displayed on the lower part of the LCD (E.g. TEMP °C).

Use the SET/HOLD button to change the temperature unit, and then press the ϕ /MODE button to return to the normal measuring mode.

BATTERY REPLACEMENT

The meter displays the remaining battery percentage every time it is switched on. When the battery level is below 5%, the \square symbol on the bottom left of the LCD lights up to indicate a low battery condition. The batteries should be replaced soon. If the battery level is low enough to cause erroneous readings, the meter shows "0%" and the Battery Error Prevention System (BEPS) will automatically turn the meter off.

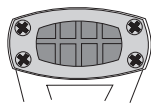

To change the batteries, remove the 4 screws located on the top of the meter. Once the top has been removed, carefully replace the 4 batteries located in the compartment while paying attention to their polarity.

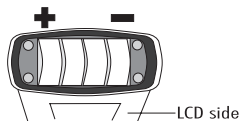

Replace the top, making sure that the gasket is properly seated in place, and tighten the screws to ensure a watertight seal.

FACTORY RECALIBRATION

The ORP range is factory calibrated.

Contact your nearest Hanna Service Center for recalibration, if necessary.

ELECTRODE MAINTENANCE

- When not in use, rinse the electrode with water to minimize contamination and store it with a few drops of HI 70300 storage solution in the protective cap after use. DO NOT USE DISTILLED OR DEIONIZED WATER FOR STORAGE PURPOSES.

- If the electrode has been left dry, soak in storage solution for at least one hour to reactivate it.
- To prolong the life of the electrode, it is recommended to clean it monthly by immersing it in the HI 7061 cleaning solution for half an hour. Afterwards, rinse it thoroughly with tap water.
- The ORP electrode can be easily replaced by using the supplied tool (HI 73128). Insert the tool into the electrode cavity as shown below.

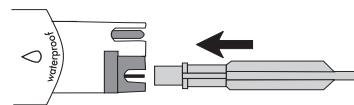

Rotate the electrode counterclockwise.

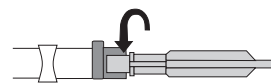

Pull the electrode out by using the other side of the tool.

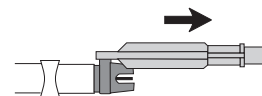

Insert a new ORP electrode following the above instructions in reverse order.

ACCESSORIES

HI 73120	Replaceable ORP electrode
HI 73128	Electrode removal tool
HI 7021M	ORP test solution (240 mV), 230 mL bottle
HI 7022M	ORP test solution (470 mV), 230 mL bottle
HI 7061M	Electrode cleaning solution, 230 mL bottle
HI 70300M	Electrode storage solution, 230 mL bottle
HI 7091M	Pretreatment reducing solution, 230 mL bottle
HI 7092M	Pretreatment oxidizing solution, 230 mL bottle

HANNA WATERPROOF TESTERS

Hanna offers a complete line of waterproof, microprocessor-based testers for measurement of pH, Temperature, EC, TDS and ORP.

Choose the instruments which best meet your needs:

- HI 98120 ORP (mV) and Temperature (°C & °F)
- HI 98121 pH (0.01 resolution), ORP (mV) and Temperature (°C & °F)
- HI 98127 pH (0.1 resolution) and Temperature (°C & °F)
- HI 98128 pH (0.01 resolution) and Temperature (°C & °F)
- HI 98129 pH (0.01 resolution), EC/TDS Low Range ($\mu\text{S}/\text{cm}$ & ppm) and Temperature (°C & °F)
- HI 98130 pH (0.01 resolution), EC/TDS High Range (mS/cm & ppt) and Temperature (°C & °F)
- HI 98311 EC/TDS Low Range ($\mu\text{S}/\text{cm}$ & ppm) and Temperature (°C & °F)
- HI 98312 EC/TDS High Range (mS/cm & ppt) and Temperature (°C & °F)