

HI97771

Free Chlorine &
Total Chlorine Ultra High Range
Photometer



INSTRUCTION MANUAL



TABLE OF CONTENTS

1. PRELIMINARY EXAMINATION 4

2. SAFETY MEASURES 5

3. ABBREVIATIONS 5

4. SPECIFICATIONS 6

5. DESCRIPTION 7

 5.1. GENERAL DESCRIPTION & INTENDED USE 7

 5.2. FUNCTIONAL DESCRIPTION 8

 5.3. PRECISION & ACCURACY 9

 5.4. PRINCIPLE OF OPERATION 9

 5.5. OPTICAL SYSTEM 10

6. GENERAL OPERATIONS 11

 6.1. METER VALIDATION: CAL CHECK & CALIBRATION 11

 6.2. GLP 13

 6.3. LOGGING DATA & LOG RECALL 13

 6.4. GENERAL SETUP 14

 6.5. REAGENTS & ACCESSORIES 16

 6.6. CONTEXTUAL HELP 16

 6.7. BATTERY MANAGEMENT 17

7. PHOTOMETER 18

 7.1. METHOD SELECTION 18

 7.2. COLLECTING & MEASURING SAMPLES AND REAGENTS 18

 7.3. CUVETTE PREPARATION 19

8. METHOD PROCEDURE 21

 8.1. FREE CHLORINE (POWDER REAGENT) 21

 8.2. FREE CHLORINE (LIQUID REAGENT) 23

 8.3. TOTAL CHLORINE UHR 26

9. WARNING & ERROR DESCRIPTIONS 28

10. BATTERY REPLACEMENT 30

11. ACCESSORIES 31

 11.1. REAGENT SETS 31

 11.2. OTHER ACCESSORIES 31

CERTIFICATION 32

RECOMMENDATIONS FOR USERS 32

WARRANTY 33

1. PRELIMINARY EXAMINATION

Remove the instrument and accessories from the packaging and examine it carefully.

Each **HI97771C** is delivered in a rugged carrying case and is supplied with:

- Sample cuvette (2 pcs.)
- Sample cuvette cap (2 pcs.)
- Plastic stopper (2 pcs.)
- **A ZERO** - CAL Check Cuvette A
- **HI97701B** - CAL Check Cuvette B for Free and Total Chlorine (Powder & Liquid)
- **HI97771B** - CAL Check Cuvette B for Total Chlorine Ultra High Range
- Cloth for wiping cuvettes
- Scissors
- 1.5V AA Alkaline batteries
- CAL Check standard certificate
- Instrument quality certificate
- Instruction manual

Each **HI97771** is delivered in a cardboard box and is supplied with:

- Sample cuvette (2 pcs.)
- Sample cuvette cap (2 pcs.)
- Plastic stopper (2 pcs.)
- 1.5V AA Alkaline batteries
- Instrument quality certificate
- Instruction manual

Note: *Save all packing material until you are sure that the instrument works correctly. Any damaged or defective item must be returned in its original packing material with the supplied accessories.*

2. SAFETY MEASURES



- The chemicals contained in the reagent kits may be hazardous if improperly handled.
- Read the Safety Data Sheets (SDS) before performing tests.
- Safety equipment: Wear suitable eye protection and clothing when required, and follow instructions carefully.
- Reagent spills: If a reagent spill occurs, wipe up immediately and rinse with plenty of water. If reagent contacts skin, rinse the affected area thoroughly with water. Avoid breathing released vapors.
- Waste disposal: For proper disposal of reagent kits and reacted samples, contact a licensed waste disposal provider.

3. ABBREVIATIONS

mg/L	milligrams per liter (ppm)
mL	milliliter
°C	degree Celsius
°F	degree Fahrenheit
DPD	N,N-Diethyl-p-phenylenediamine
EPA	US Environmental Protection Agency
GLP	Good Laboratory Practice
HDPE	High Density Polyethylene
LED	Light Emitting Diode
NIST	National Institute of Standards and Technology
UHR	Ultra High Range

4. SPECIFICATIONS

Free Chlorine (All Methods)	Range	0.00 to 5.00 mg/L (as Cl ₂)
	Resolution	0.01 mg/L
	Accuracy	±0.03 mg/L ±3% of reading at 25 °C
	Method	Adaptation of US EPA Method 330.5, DPD Colorimetric Method
Total Chlorine UHR	Range	0 to 500 mg/L (as Cl ₂)
	Resolution	1 mg/L
	Accuracy	±3 mg/L ±3% of reading at 25 °C
	Method	Adaptation of Standard Methods for Examination of Water and Wastewater, 20 th Edition, 4500-Cl
Measurement System	Light source	Light Emitting Diode
	Bandpass filter	525 nm
	Bandpass filter bandwidth	8 nm
	Bandpass filter wavelength accuracy	±1.0 nm
	Light detector	Silicon photocell
	Cuvette type	Round 24.6 mm diameter (22 mm inside)
Additional Specifications	Auto logging	50 readings
	Display	128 x 64 pixel B/W LCD with backlight
	Auto-off	After 15 minutes of inactivity (30 minutes before a READ measurement)
	Battery type	1.5 V AA Alkaline (3 pcs.)
	Battery life	> 800 measurements (without backlight)
	Environment	0 to 50 °C (32 to 122 °F); 0 to 100% RH, non-serviceable
	Dimensions	142.5 x 102.5 x 50.5 mm (5.6 x 4.0 x 2.0")
	Weight (with batteries)	380 g (13.4 oz.)
	Case ingress protection rating	IP67, floating case

5. DESCRIPTION

5.1. GENERAL DESCRIPTION & INTENDED USE

The **HI97771** is an auto-diagnostic portable photometer that benefits from Hanna's years of experience as a manufacturer of analytical instruments. It has an advanced optical system that uses a Light Emitting Diode (LED) and a narrow band interference filter that allows for accurate and repeatable readings.

The optical system is sealed from outside dust, dirt and water. The meter uses an exclusive positive-locking system to ensure that the cuvettes are placed into the holder in the same position every time.

With the CAL Check™ functionality, users are able to validate the performance of the instrument at any time and apply a user calibration (if necessary). Hanna Instruments CAL Check cuvettes are made with NIST traceable standards.

The built-in tutorial mode guides users step-by-step through the measurement process. It includes all steps required for sample preparation, the required reagents and quantities.

The **HI97771** meter measures free chlorine from 0.00 to 5.00 mg/L (ppm) and total chlorine from 0 to 500 mg/L (ppm).

The method for free chlorine is an adaptation of US EPA Method 330.5, DPD Colorimetric Method.

The method for total chlorine is an adaptation of Standard Methods for Examination of Water and Wastewater, 20th Edition, 4500-Cl.

The **HI97771** photometer is a compact and versatile meter suitable for field or bench measurements, featuring a:

- Sophisticated optical system
- Meter validation using certified CAL Check cuvettes
- Tutorial mode guides the user step-by-step
- Auto logging
- Waterproof IP67, floating case
- GLP features



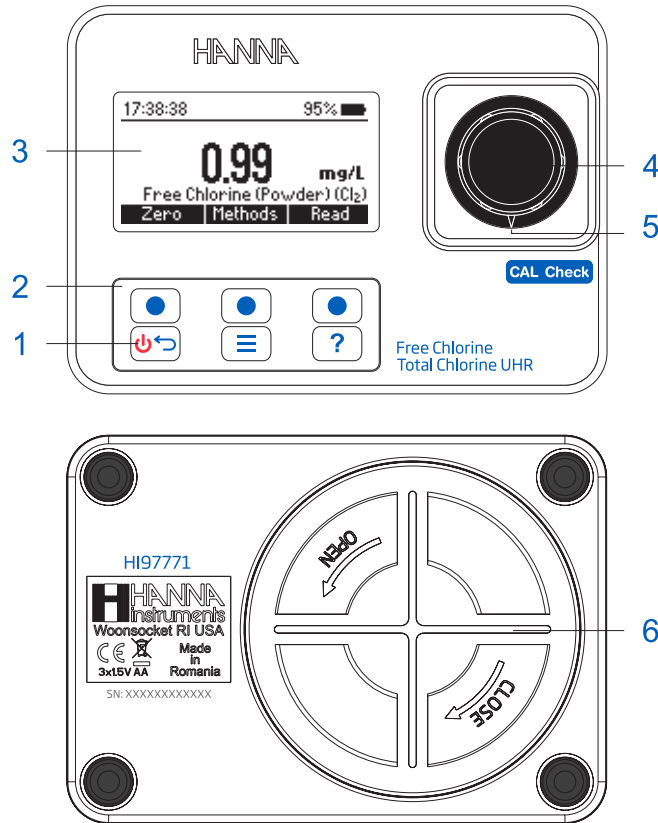

5.2. FUNCTIONAL DESCRIPTION



- | | | |
|------------------------|---------------------------------|------------------|
| 1. ON/OFF power button | 3. Liquid Crystal Display (LCD) | 5. Indexing mark |
| 2. Keypad | 4. Cuvette holder | 6. Battery cover |

Keypad Description

The keypad contains 3 direct keys and 3 functional keys with the following functions:

-  Press the functional key to perform the function displayed above it on the LCD.
-  Press and hold to power off/on. Press briefly to return to the previous screen.
-  Press to access the menu screen.
-  Press to display the context-sensitive help menu.

5.3. PRECISION & ACCURACY

Precision is how closely repeated measurements are to one another. Precision is usually expressed as standard deviation (SD).

Accuracy is defined as the closeness of a test result to the true value and is method specific.

Although good precision suggests good accuracy, precise results can be inaccurate. The figure explains these definitions.

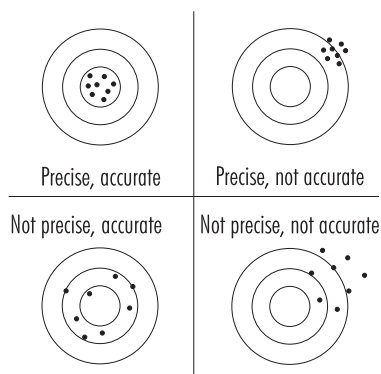

5.4. PRINCIPLE OF OPERATION

Absorption of light is a typical phenomenon of interaction between electromagnetic radiation and matter. When a light beam crosses a substance, some of the radiation may be absorbed by atoms, molecules or crystal lattices. Photometric chemical analysis is based on specific chemical reactions between a sample and reagent to produce a light-absorbing compound.

If pure absorption occurs, the fraction of light absorbed depends both on the optical path length through the matter and on the physical-chemical characteristics of the substance according to the Lambert-Beer Law. If all other factors are constant, the concentration "c" can be calculated from the absorbance of the substance.

Lambert-Beer Law:

$$-\log I/I_0 = \epsilon_{\lambda} c d$$

or

$$A = \epsilon_{\lambda} c d$$

- I_0 = intensity of incident light beam
- I = intensity of light beam after absorption
- ϵ_{λ} = molar extinction coefficient at wavelength λ .
- c = molar concentration of the substance
- d = optical path through the substance

5.5. OPTICAL SYSTEM

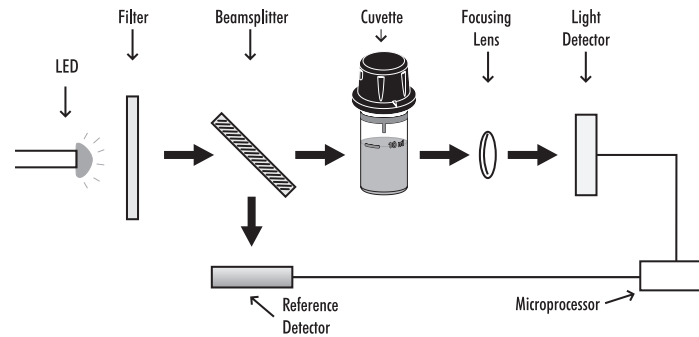

Instrument Block Diagram

The internal reference system (reference detector) of the [HI97771](#) photometer compensates for any drifts due to power fluctuations or ambient temperature changes, providing a stable source of light for your blank (zero) measurement and sample measurement.

LED light sources offer superior performance compared to tungsten lamps. LEDs have a much higher luminous efficiency, providing more light while using less power. They also produce little heat, which could otherwise affect electronic stability. LEDs are available in a wide array of wavelengths, whereas tungsten lamps have poor blue/violet light output.

Improved optical filters ensure greater wavelength accuracy and allow a brighter, stronger signal to be received. The end result is higher measurement stability and less wavelength error.

A focusing lens collects all of the light that exits the cuvette, eliminating errors from cuvette imperfections and scratches, eliminating the need to index the cuvette.

6. GENERAL OPERATIONS

6.1. METER VALIDATION: CAL CHECK & CALIBRATION

Validation of the HI97771 involves verifying the concentration of the certified CAL Check standards. The CAL Check screen guides the user step-by-step through the validation process and user calibration (if necessary).

WARNING: Do not use any solutions or standards other than the Hanna Instruments® CAL Check Standards. For accurate validation and calibration results, please perform these at room temperature, 18 to 25 °C (64.5 to 77.0 °F).

Note: CAL Check Standards will not read the specified value in measurement mode. Protect the CAL Check cuvettes from direct sunlight by keeping them in the original packing. Store between 5 and 30 °C (41 to 86 °F), do not freeze.

To perform a CAL Check:

1. Press the  key to enter menu. Use the functional keys to select CAL Check / Calibration and press **Select**.



The "Not Available" message or the date, time and status of the last CAL Check will be displayed on the screen.

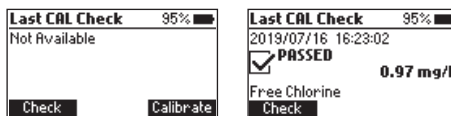

Note: CAL Check & Calibration is for the selected method.

2. Press **Check** to start a new CAL Check. Press the  key at any time to abort the validation process.
3. Use the functional keys to enter the certificate value of the calibration standard found on the CAL Check Standard Certificate. Press **Next** to continue.

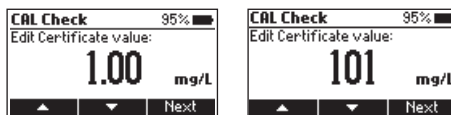

Note: This value will be saved in the instrument for future validation. If a new set of calibration standards is obtained, please update the certificate value.

- Insert the **A ZERO** CAL Check Cuvette A then press **Next** to continue. The “Please wait...” message will be displayed during the measurement.

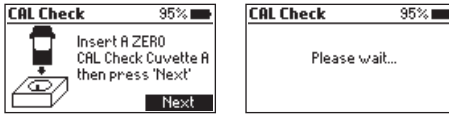

- Insert the CAL Check Cuvette B for the selected method (**HI97701B** for Free Chlorine or **HI97771B** for Total Chlorine Ultra High Range) then press **Next** to continue. The “Please wait...” message will be displayed during the measurement.



- When the CAL Check is complete, the display will show one of the following messages and the value obtained during the measurement:
 - “**PASSED**”: The measured value is within the accuracy specification, no user calibration is required.

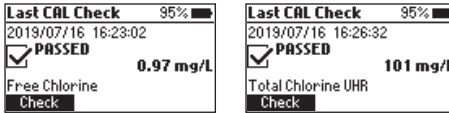

- “**OUT OF SPECIFICATION**” and **Calibrate** is available: The measured value is near the expected value. To update the user calibration press **Calibrate**. Press **Accept** to confirm or **Cancel** to return to the previous screen.

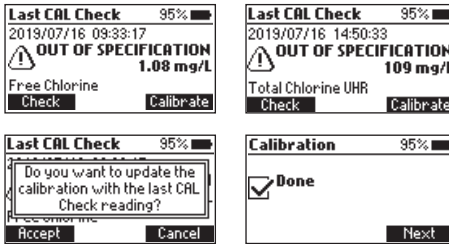

- “**OUT OF SPECIFICATION**”: A user calibration is not allowed, the measured value is outside of the tolerance window. Check the certified value, expiration date and clean the outside of the cuvette. Repeat the CAL Check procedure. If this error continues, contact your nearest Hanna Instruments Customer Service Center.

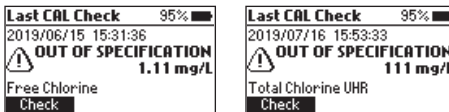

6.2. GLP

Press the  key to enter the menu. Use the functional keys to select *GLP* and press **Select**. Good Laboratory Practice (GLP) shows the date and time of the last user calibration (if available) or factory calibration. To erase the last user calibration and to clear the CAL Check, press **Clear** and follow the prompts. Press **Yes** to erase and return to the factory calibration data or **No** to exit the clear procedure.

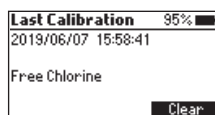

6.3. LOGGING DATA & LOG RECALL

The instrument features a data autolog function to help users keep track of all measurements. Every time a measurement is made the data is automatically saved. The data log can hold 50 individual measurements. When the data log is full (50 data points), the meter will rewrite the oldest data point.

Viewing and deleting the data is possible using the **Log Recall** menu.

Press the  key to enter the menu. Use the functional keys to select *Log Recall* and press **Select**.



Use the functional keys to highlight a log and press **Info** to view additional information about the log. From this screen **Next** and **Previous** can be used to view other logs.

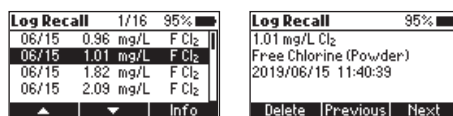

Press **Delete** to erase logged data. After pressing **Delete** a prompt on display is asking for confirmation.

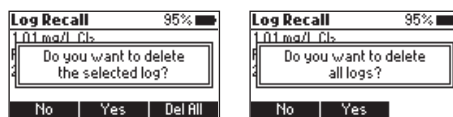

Press **No** or the  key to return to the previous screen.

Press **Yes** to delete selected log.

Press **Del All** to erase all the logged data. If **Del All** is pressed, follow the prompt to confirm. Press **Yes** to delete all logged data, **No** or the  key to return to the log recall.

6.4. GENERAL SETUP

Press the  key to enter the menu. Use the functional keys to select *Setup* and press **Select**. Use the functional keys to highlight desired option.

Backlight

Option: 0 to 100 %

Press **Modify** to access the backlight intensity. Use the functional keys to increase or decrease the value. Press **Accept** to confirm or the  key to return to the *Setup* menu without saving the new value.

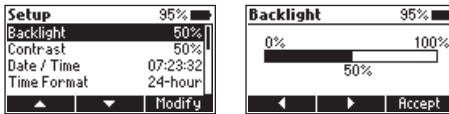

Contrast

Option: 0 to 100 %

Press **Modify** to change the display's contrast. Use the functional keys to increase or decrease the value. Press **Accept** to confirm the value or the  key to return to the *Setup* menu without saving the new value.

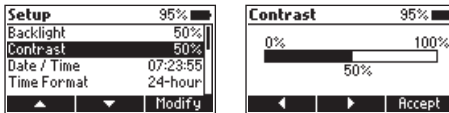

Date & Time

Press **Modify** to change the date and time. Press the functional keys to highlight the value to be modified (year, month, day, hour, minute or second). Press **Edit** to modify the highlighted value. Use the functional keys to change the value.

Press **Accept** to confirm or the  key to return to the previous screen.

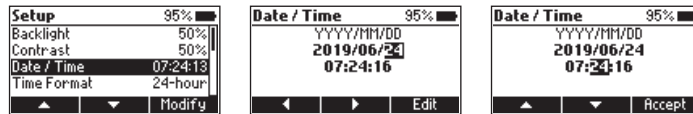

Time Format

Option: AM/PM or 24-hour

Press the functional key to select the desired time format.

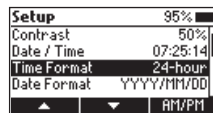

Date Format

Press **Modify** to change the date format. Use the functional keys to select the desired format. Press **Accept** to confirm or the  key to return to the *Setup* menu without saving the new format.

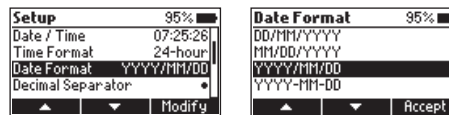

Decimal Separator

Option: Comma (,) or Period (.)

Press the functional key to select the desired decimal separator. The decimal separator is used on the measurement screen.

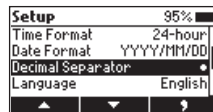

Language

Press **Modify** to change the language. Use the functional keys to select the desired language. Press **Accept** to choose one of the languages installed.



Beeper

Option: Enable or Disable

When enabled, a short beep is heard every time a key is pressed. A long beep alert sounds when the pressed key is not active or an error is detected. Press the functional key to enable or disable the beeper.

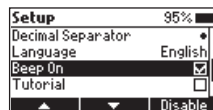

Tutorial

Option: Enable or Disable

When enabled, the user will be guided step-by-step through the measurement procedure.

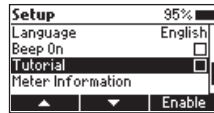

Meter Information

Press **Select** to view the model, serial number, firmware version and selected language. Press the key to return to the *Setup* menu.

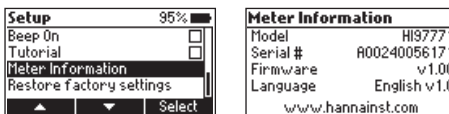

Restore Factory Settings

Press **Select** to reset to factory settings. Press **Accept** to confirm or **Cancel** to exit without restoring the factory settings.

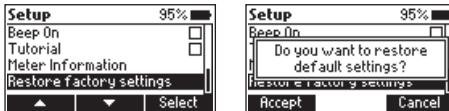

6.5. REAGENTS & ACCESSORIES

Press the key to enter the menu. Use the functional keys to select *Reagents / Accessories* and press **Select** to access a list of reagents and accessories. To exit press the key.

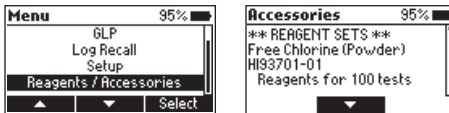

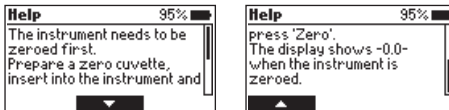

6.6. CONTEXTUAL HELP

The HI97771 offers an interactive contextual help mode that assists the user at any time. To access the help screen press the key.



The instrument will display additional information related to the current screen. To read all the available information, scroll the text using the functional keys.

To exit help mode press the  or the  key and the meter will return to the previous screen.

6.7. BATTERY MANAGEMENT

The meter will perform an auto-diagnostic test when it is powered on. During this test, the Hanna Instruments® logo will appear on the LCD. If the auto-diagnostic test was successful, the meter is ready for use. The battery icon on the LCD will indicate the battery status:

- battery full

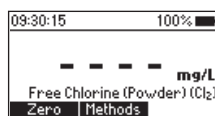

- battery below 10%, replace the batteries soon

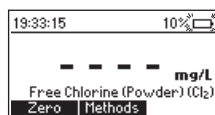

- battery is low, replace the batteries with new ones

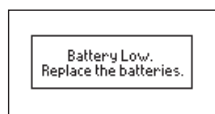

To conserve battery, the meter will turn off automatically after 15 minutes of inactivity. If a zero reading has been done but not a read, auto-off time is increased to 30 minutes.

7. PHOTOMETER

7.1. METHOD SELECTION

Press **Methods** when in measurement mode to access the list of methods. Use the functional keys to highlight the desired method then press **Select**.



The selected method will be saved when the instrument is powered off.

7.2. COLLECTING & MEASURING SAMPLES AND REAGENTS

Proper Use of Powder Packet

1. Use scissors to open the powder packet.
2. Push the edges of the packet to form a spout.
3. Pour out the content of the packet.

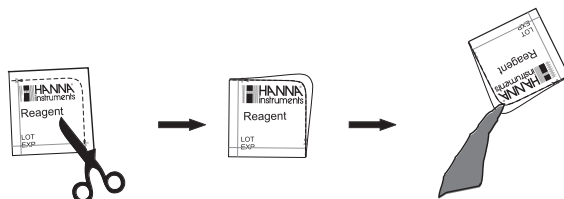

Proper Use of Dropper Bottle

1. Tap the dropper on the table several times and wipe the outside of the tip with a cloth.
2. Always keep the dropper bottle in a vertical position while dosing the reagent.

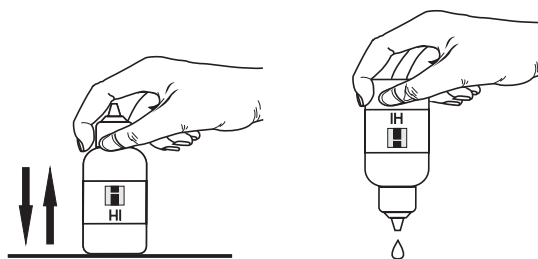

7.3. CUVETTE PREPARATION

Proper mixing is very important for reproducibility of the measurements. The proper mixing technique is listed in the method procedure.

- (a) Invert the cuvette a couple of times or for a specified time: hold the cuvette in the vertical position. Turn the cuvette upside-down and wait for all of the solution to flow to the cap end, then return the cuvette to the upright vertical position and wait for all of the solution to flow to the cuvette bottom. This is one inversion. The correct speed for this mixing technique is 10-15 complete inversions in 30 seconds. This mixing technique is indicated with “invert to mix” and the following icons:

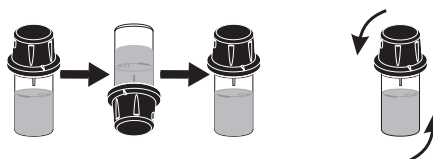

- (b) The mixing method is indicated with “shake gently” using one of the following icons:



- (c) The mixing method is indicated with “swirl” using one of the following icons:

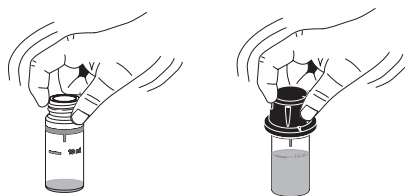

In order to avoid reagent leaking and to obtain more accurate measurements, close the cuvette first with the supplied HDPE plastic stopper  and then the black cap.



Whenever the cuvette is placed into the measurement holder, it must be dry outside and free of fingerprints, oil or dirt. Wipe it thoroughly with [HI731318](#) microfiber cleaning cloth or a lint-free wipe prior to insertion.

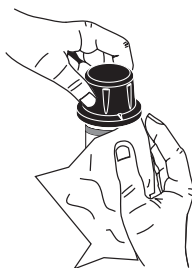

Shaking the cuvette can generate bubbles in the sample, causing higher readings. To obtain accurate measurements, remove such bubbles by swirling or by gently tapping the cuvette.

Do not let the reacted sample stand too long after reagent has been added. For best accuracy, respect the timings described in the method.

It is possible to take multiple readings in a row, but it is recommended to take a new zero reading for each sample and to use the same cuvette for zeroing and measurement when possible.

Discard the sample immediately after the reading has been taken, or the glass might become permanently stained.

All the reaction times reported in this manual are at 25 °C (77 °F). In general, the reaction time should be increased for temperatures lower than 20 °C (68 °F), and decreased for temperatures higher than 25 °C (77 °F).

8. METHOD PROCEDURE

8.1. FREE CHLORINE (POWDER REAGENT)

REQUIRED REAGENTS

Code	Description	Quantity
HI93701-0	Free Chlorine Reagent	1 packet

REAGENT SETS

HI93701-01 Free Chlorine Reagent - 100 tests

HI93701-03 Free Chlorine Reagent - 300 tests

For other accessories see ACCESSORIES section.

MEASUREMENT PROCEDURE

- Select the [Free Chlorine \(Powder\)](#) method using the procedure described in the METHOD SELECTION section.

*Note: If tutorial mode is disabled, follow the measurement procedure below. If the tutorial mode is enabled, press **Measure** and follow the messages on the screen.*

- Fill the cuvette with 10 mL of unreacted sample (up to the mark). Replace the plastic stopper and the cap.

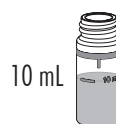

- Insert the cuvette into the holder and ensure that the notch on the cap is positioned securely in the groove.

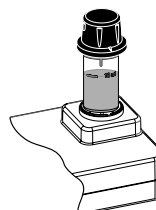

- Press **Zero**. The display will show “-0.0-” when the meter is zeroed and ready for measurement.

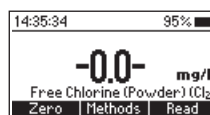
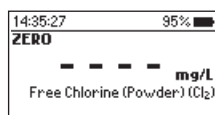
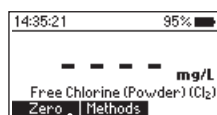

- Remove the cuvette.
- Add the content of one packet of HI93701-0 Free Chlorine Reagent. Replace the plastic stopper and the cap. Shake gently for 20 seconds.

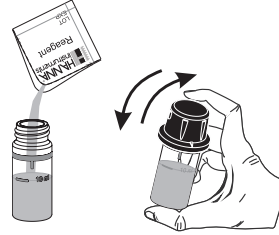

- Insert the cuvette into the holder and ensure that the notch on the cap is positioned securely in the groove.

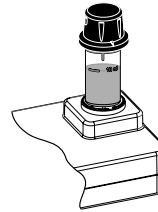

- Press **Read**. The display will show a 1 minute countdown prior to the measurement. To skip the timer, press **Read** twice. When the timer ends, the meter will perform the reading. The instrument displays the results in **mg/L of chlorine (Cl₂)**.

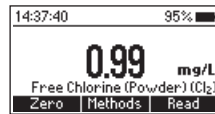
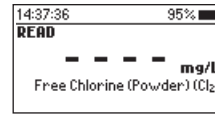
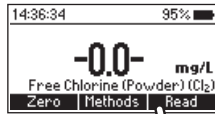

INTERFERENCES

Interference may be caused by:

- Bromine, Iodine, Oxidized forms of Chromium and Manganese, Ozone
- Hardness greater than 500 mg/L CaCO₃, to remove the interference shake the sample for approximately 2 minutes after adding the powder reagent
- Alkalinity greater than 250 mg/L CaCO₃ or acidity value greater than 150 mg/L CaCO₃, the color of the sample may develop only partially or rapidly fade, to remove the interference neutralize the sample with diluted HCl or NaOH

8.2. FREE CHLORINE (LIQUID REAGENT)

REQUIRED REAGENTS

Code	Description	Quantity
HI93701A-F	Free Chlorine Reagent A	3 drops
HI93701B-F	Free Chlorine Reagent B	3 drops

REAGENT SETS

HI93701-F Free Chlorine Reagent - 300 tests

For other accessories see ACCESSORIES section.

MEASUREMENT PROCEDURE

- Select the **Free Chlorine (Liquid)** method using the procedure described in the METHOD SELECTION section.

*Note: If tutorial mode is disabled, follow the measurement procedure below. If the tutorial mode is enabled, press **Measure** and follow the messages on the screen.*

- Fill the cuvette with 10 mL of unreacted sample (up to the mark). Replace the plastic stopper and the cap.



- Insert the cuvette into the holder and ensure that the notch on the cap is positioned securely in the groove.

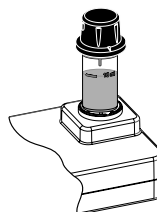

- Press **Zero**. The display will show “-0.0-” when the meter is zeroed and ready for measurement.

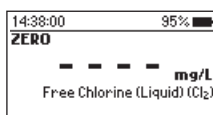
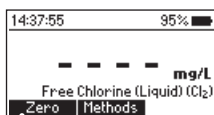

- Remove the cuvette.

- To an empty cuvette add 3 drops of HI93701A-F Free Chlorine Reagent A and 3 drops of HI93701B-F Free Chlorine Reagent B.

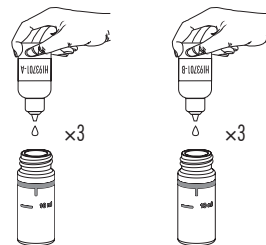

- Swirl gently to mix.

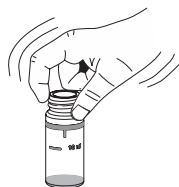

- Add 10 mL of unreacted sample (up to the mark). Replace the plastic stopper and the cap. Shake gently to mix.

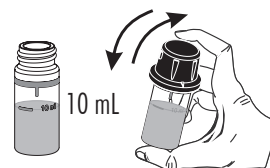

- Insert the cuvette into the holder and ensure that the notch on the cap is positioned securely in the groove.

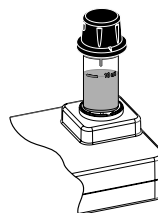

- Press **Read**. The display will show a 1 minute countdown prior to the measurement. To skip the timer, press **Read** twice. When the timer ends, the meter will perform the reading. The instrument displays the results in mg/L of chlorine (Cl₂).

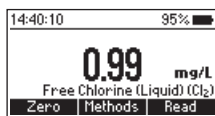
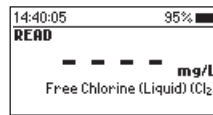
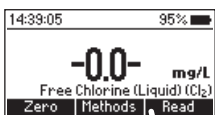

INTERFERENCES

Interference may be caused by:

- Bromine, Iodine, Oxidized forms of Chromium and Manganese, Ozone
- Hardness greater than 500 mg/L CaCO_3 , to remove the interference shake the sample for approximately 2 minutes after adding the powder reagent
- Alkalinity greater than 250 mg/L CaCO_3 or acidity value greater than 150 mg/L CaCO_3 , the color of the sample may develop only partially or rapidly fade, to remove the interference neutralize the sample with diluted HCl or NaOH

8.3. TOTAL CHLORINE UHR

REQUIRED REAGENTS

Code	Description	Quantity
HI95771A-0	Total Chlorine UHR Reagent A	1 packet
HI95771B-0	Total Chlorine UHR Reagent B	1 packet

REAGENT SETS

HI95771-01	Total Chlorine UHR Reagent - 100 tests
HI95771-03	Total Chlorine UHR Reagent - 300 tests

For other accessories see ACCESSORIES section.

MEASUREMENT PROCEDURE

- Select the **Total Chlorine UHR** method using the procedure described in the METHOD SELECTION section.

*Note: If tutorial mode is disabled, follow the measurement procedure below. If the tutorial mode is enabled, press **Measure** and follow the messages on the screen.*

- Fill the cuvette with 10 mL of unreacted sample (up to the mark). Replace the plastic stopper and the cap.

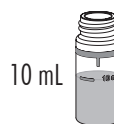

- Insert the cuvette into the holder and ensure that the notch on the cap is positioned securely in the groove.

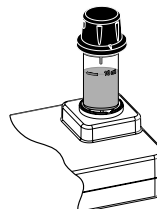

- Press **Zero**. The display will show “-0.0-” when the meter is zeroed and ready for measurement.

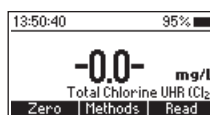
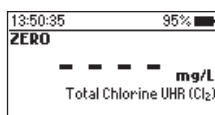
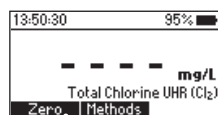

- Remove the cuvette.

- Add the content of one packet of **HI95771A-0** Total Chlorine UHR Reagent A and the content of one packet of **HI95771B-0** Total Chlorine UHR Reagent B. Replace the plastic stopper and the cap. Shake gently for 20 seconds.

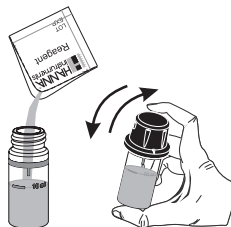

- Press **Read**. The display will show a 1 minute countdown prior to the measurement. To skip the timer, press **Read** twice. After 1 minute, invert the cuvette 5 times.

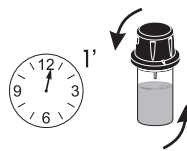

- Insert the cuvette into the holder and ensure that the notch on the cap is positioned securely in the groove.

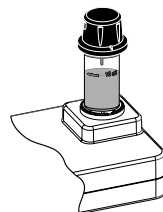

- Press **Read** twice. The instrument displays the results in **mg/L of chlorine (Cl₂)**.

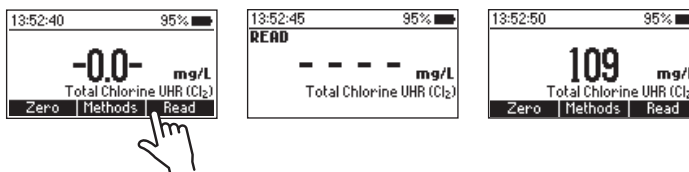

INTERFERENCES

Interference may be caused by:

- Bromine, Chlorine Dioxide, Chromium, Iodine, Oxidized Manganese, Ozone

9. WARNING & ERROR DESCRIPTIONS

The instrument shows clear warning messages when erroneous conditions appear and when measured values are outside the expected range.

The information below provides an explanation of the errors and warnings, and recommended action to be taken.

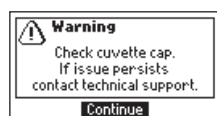

There is an excess amount of ambient light reaching the detector. Ensure that the notch on the cap is positioned securely in the groove before performing any measurements. If the issue persists, please contact Hanna Instruments technical support.

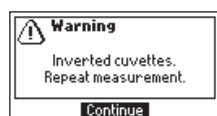

The sample and the zero cuvettes are inverted. Swap the cuvettes and repeat the measurement.

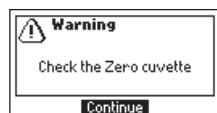

There is either too much light or the instrument can not adjust the light level. Please check the preparation of the zero cuvette and that the sample does not contain any debris.



The meter is either overheating or its temperature has dropped too low to operate within published accuracy specifications. The meter must be between 0 and 50 °C (32 and 122 °F) to perform any measurements.



Meter temperature has changed significantly since the zero measurement has been performed. The zero measurement must be performed again.



The measured value is outside the limits of the method. Verify that the sample does not contain any debris. Check the sample preparation and the measurement preparation.



Date and time settings have been lost. Please reset the values. If the issue persists, please contact Hanna Instruments technical support.



English is the only available language. Help function is not available. Restart the meter. If the issue persists, please contact Hanna Instruments technical support.

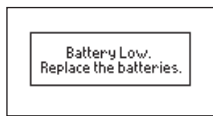

Battery level is too low for the meter to function properly. Replace the batteries with new ones.

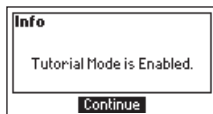

Tutorial mode has been enabled in the Setup menu. Press **Continue** and follow the prompt on the screen. Tutorial mode can be disabled in the Setup menu.

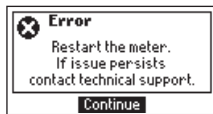

A critical error has occurred. Restart the meter. If the issue persists, please contact Hanna Instruments technical support.

10. BATTERY REPLACEMENT

To replace the instrument's batteries, follow these steps:

- Turn the instrument off by pressing and holding the  key.
- Remove the battery cover by turning it counterclockwise.
- Remove the old batteries, replace them with three new 1.5V AA batteries.
- Replace the battery cover, turn it clockwise to close.

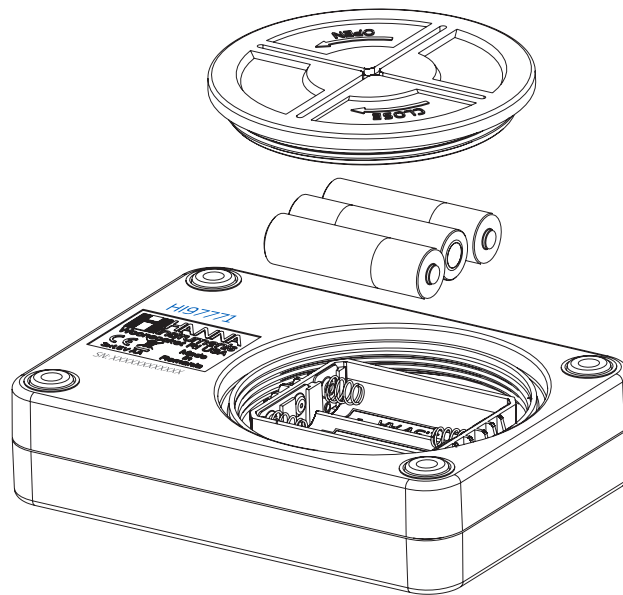

11. ACCESSORIES

11.1. REAGENT SETS

Code	Description
HI93701-01	Free Chlorine Reagent - 100 tests (powder)
HI93701-03	Free Chlorine Reagent - 300 tests (powder)
HI93701-F	Free Chlorine Reagent - 300 tests (liquid)
HI95771-01	Total Chlorine UHR Reagent - 100 tests
HI95771-03	Total Chlorine UHR Reagent - 300 tests

11.2. OTHER ACCESSORIES

Code	Description
HI7101413	blue carrying case for HI977xx and 3 CAL Check cuvettes
HI731318	cloth for wiping cuvettes (4 pcs.)
HI731331	glass cuvette (4 pcs.)
HI731336N	cap for glass cuvette (4 pcs.)
HI93703-50	cuvette cleaning solution (230 mL)
HI97701-11	CAL Check [®] standards for Free and Total Chlorine - cuvette kit
HI97771-11	CAL Check [®] standards for Total Chlorine UHR - cuvette kit

CERTIFICATION

All Hanna Instruments conform to the CE European Directives.



Disposal of Electrical & Electronic Equipment. The product should not be treated as household waste. Instead hand it over to the appropriate collection point for the recycling of electrical and electronic equipment which will conserve natural resources.

Disposal of waste batteries. This product contains batteries, do not dispose of them with other household waste. Hand them over to the appropriate collection point for recycling.

Ensuring proper product and battery disposal prevents potential negative consequences for the environment and human health. For more information, contact your city, your local household waste disposal service, the place of purchase or go to



RECOMMENDATIONS FOR USERS

Before using this product, make sure it is entirely suitable for your specific application and for the environment in which it is used. Any variation introduced by the user to the supplied equipment may degrade the meter's performance. For yours and the meter's safety do not use or store the meter in hazardous environments.

WARRANTY

The HI97771 is warranted for two years against defects in workmanship and materials when used for its intended purpose and maintained according to instructions. This warranty is limited to repair or replacement free of charge. Damage due to accidents, misuse, tampering or lack of prescribed maintenance is not covered.

If service is required, contact your local Hanna Instruments Office. If under warranty, report the model number, date of purchase, serial number (engraved on the bottom of the meter) and the nature of the problem. If the repair is not covered by the warranty, you will be notified of the charges incurred. If the meter is to be returned to Hanna Instruments, first obtain a Returned Goods Authorization (RGA) number from the Technical Service department and then send it with shipping costs prepaid. When shipping any meter, make sure it is properly packed for complete protection.