

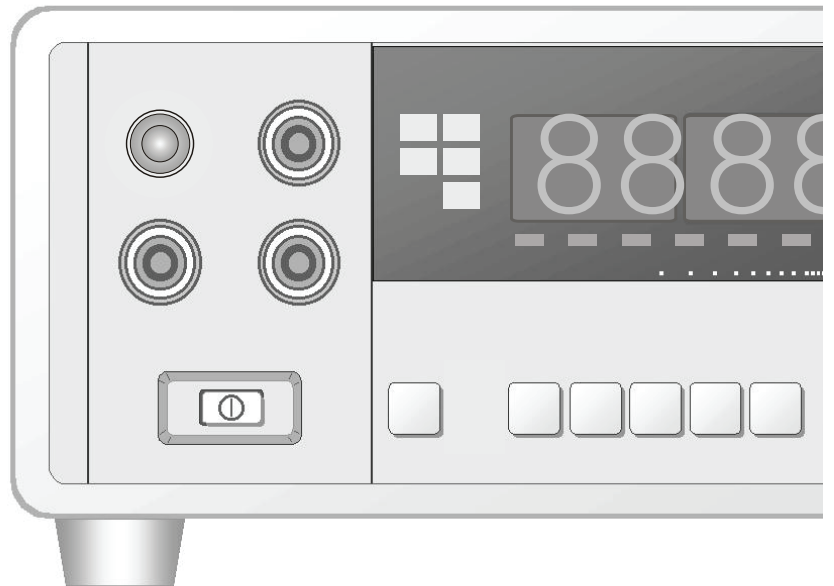

BENCH-TOP INSTRUMENT

**FG-7002C / 5C
2MHz / 5MHz**

**Sweep Function Generator
Operation Manual**



 **EZ Digital Co.,Ltd.**

WARRANTY

Warranty service covers a period of one year from the date of original purchase.

In case of technical failure within one year, our service center or sales outlet free of charge will provide repair service.

We charge customers for repair after the one-year warranty period has been expired. Provided that against any failure resulted from the user's negligence, natural disaster or accident, we charge you for repairs regardless of the warranty period.

For more professional repair service, be sure to contact our service center or sales outlet.

Introduction

Thank you for purchasing our product, electronic measuring instruments produced by us are high technology products made under strict quality control. We guarantee their exceptional precision and utmost reliability. For proper use of the product, please read this operation manual carefully.



Note







1. To fully maintain the precision and reliability of the product use it within the range of standard setting (temperature 10 °C~35 °C, humidity 45%~85%)
2. After turning of power, please allow a pre-heating period of as long as some 30 minutes before use.
3. This equipment should be used with a triple line power cord for safety.
4. For quality improvement the exterior design and specification of the product can be changed without prior notice.
5. If you have further questions concerning use, please contact our service center or sales outlet

Safety Summary

Please take a moment to read these operating instructions thoroughly and completely before operating this instrument. Pay particular attention to WARNINGS used for conditions and actions that pose hazard to the user and CAUTIONS used for conditions and actions that may damage the instrument.

- Always to inspect the instrument and other accessories for any sign of damage or abnormality before every use.
- Never ground yourself and keep your body isolated from ground.
- Never touch exposed wiring, connections or any live circuit conductors.
- Do not install substitute parts or perform any unauthorized modification to the instrument.
- Use caution when working above 60V DC or 30V AC rms. Such voltages pose a shock hazard.
- Remember that line voltage is present on some power input circuit points such as on-off switches, fuse, power transformers, etc., even when the equipment is turn off.
- Also, remember that high voltage may appear at unexpected points in defective equipment.

Safety Symbols

1.  **Protective earth (ground)**
To identify any terminal which is intended for connection to an external conductor for protection against electric shock in case of a fault, or the terminal of a protective earth (ground) electrode.
2.  **Functional earth terminal on the rear panel.**
3.  **“IN” position of a bi-stable push control**
To associate the “IN” position of a bi-stable push control with the corresponding function.
4.  **“OUT” position of a bi-stable push control**
To associate the “OUT” position of a bi-stable push control with the corresponding function.
5.  **Alternation current**
To indicate on the rating plate that the equipment is suitable for alternating current only to identify relevant terminals.
6.  **Caution, risk of danger**
7.  **Caution, risk of electric shock**

CONTENTS

1. PRODUCT DESCRIPTION

1-1. Introduction	(6)
1-2. Technical Specifications	(6)
1-3. Equipment Ratings	(8)
1-4. Supplied Accessories	(8)

2. INSTALLATION

2-1. Initial Inspection	(9)
2-2. Connecting Ac Power	(9)
2-3. Cooling And Ventilation	(9)
2-4. Position	(9)
2-5. Warming-Up	(9)

3. OPERATION

3-1. Controls, indicators and connectors	(10)
3-2. 2. Operating instruction	(13)
3-3. Use As Function Generator	(13)
3-4. Use As Pulse Generator	(16)
3-5-1. TTL/CMOS Output	(18)
3-5-2. TTL/SYNC Output	(19)
3-6. Use As FM Signal Generator	(19)
3-7. External Control Of VCF	(21)
3-8. Programmed Frequency Selection	(22)
3-9. Use As Sweep Generator	(22)
3-10. Use As Externally Controlled Sweep Generator	(23)
3-11. Use As External Frequency Counter	(23)

4. MAINTENANCE

4-1. Fuse Replacement	(25)
4-2. Adjustment And Calibration	(25)
4-3. Cleaning and decontamination	(25)

5. OTHERS

5-1. Introduction	(25)
5-2. Troubleshooting By Signal Substitution	(26)
5-3. Troubleshooting By Signal Tracing	(26)
5-4. Amplifier Overload Characteristics	(27)
5-5. Amplifier Performance Evaluation Using Square Waves	(28)
5-6. Testing Speakers And Impedance Networks	(31)
5-7. Digital Frequency Selection	(32)
5-8. Additional Applications	(32)

1. PRODUCT DESCRIPTION

1.1. Introduction

This instrument is the Most Versatile Signal Source used as FUNCTION GENERATOR, SWEEP GENERATOR, PULSE GENERATOR and a FREQUENCY COUNTER, offering a wide range of applications in both analog and digital electronics such as engineering, manufacturing, servicing, education and hobbyist fields.

VCF(voltage controlled frequency) produces precision sine, square and triangle waves over the **0.02 Hz to 2 MHz; FG-7002C, 0.05Hz - 5MHz; FG-7005C** for sub-audible, audio, ultrasonic and RF applications. A continuously variable DC offset allows the output to be injected directly into circuits at the correct bias level.

Variable symmetry of the output waveforms converts the instrument to a pulse generator capable of generating rectangular waves or pulses, ramp or sawtooth waves and skewed sine waves of variable duty cycle. The sweep generator offers linear sweep with variable sweep rate and sweep width up to 100:1 frequency change. The frequency response of any active or passive device up to Maximum frequency of each model can be determined.

1-2. Technical Specifications

■ OUTPUT CHARACTERISTICS

Waveforms : Sine, Square, Triangle, Skewed Sine, Pulse, Ramp
Sawtooth, TTL Leveled Square, DC
CMOS Leveled Square(FG-7002C only)

Frequency Range : In 7 Range (1, 10, 100, 1K, 10K, 100K,1M)
FG-7002C; 0.02 Hz to 2 MHz
FG-7005C; 0.05 Hz to 5 MHz

Frequency Drift Accuracy: $\pm 2\%$ (1, 10, 100, 1K, 10K, 100K,1M Range)

Output Level : 20 Vpp in open circuit, 10 Vpp into 50 Ω Load

Output Impedance : 50 $\Omega \pm 5\%$

Attenuator : 20 dB fixed and continuously variable

■ WAVEFORM CHARACTERISTICS

Sine wave	-Flatness	: $\pm 3\text{dB}$ to <u>2MHz(FG-7002C),</u> <u>5MHz(FG-7005C)</u>
	-Distortion	: Less than 1% at 0.2 Hz to 100 KHz
Square wave	-Rise and Fall Time	: Less than 120 nS
Triangle wave	-Linearity	: More than 99% at 0.2 Hz to 100 KHz
TTL Output	-Rise and Fall time	: Less than 25 nS
	-Output Level	: TTL Level($H \geq 2.4\text{V}$, $L \leq 0.4\text{V}$)
CMOS Output	-Rise and Fall Time	: Less than 160 nS(Max. Out)
<u>(FG-7002C only)</u>	-Output Level	: 4V to 15V \pm 2V, Variable
DUTY RATIO		: 1:1 to 10 : 1

■ SWEEP FUNCTION CHARACTERISTICS

Mode	: Linear
Width	: Variable from 1 : 1 to 100 : 1
Rate	: 0.5 Hz to 50 Hz (20 mS to 2 S)
External VCF Input	:
Input Voltage	: 0 to 10 V
Input Impedance	: Approx. 1K Ω

■ FREQUENCY COUNTER CHARACTERISTICS

Display	:	<u>FG-7002C: 6 digit green LED, Gate time, MHz, KHz, Hz, mHz.</u> <u>FG-7005C : 7 digit green LED, Gate time, MHz, KHz, Hz, mHz.</u>
Frequency Range	:	<u>FG-7002C: 200 mHz to 50 MHz With Auto Range.</u> <u>FG-7005C : 200 mHz to 100 MHz With Auto Range.</u>
Accuracy	: \pm Time base Error \pm 1 count	
Time base	: 10 MHz Crystal, $\pm 20\text{ppm}$	
Input Sensitivity	: 100 mVrms	
Max. Input Voltage	: 250 Vpp	

■ DIMENSION AND WEIGHT

Dimension	: 240(W)x 270(D) x90(H)mm
Weight	: <u>Approx. 2.0Kg(FG-7002C), 3.0kg(FG-7005C)</u>

1-3. Equipment Ratings

- Power & Fuse Ratings

Input Voltage	Fuse	Power Max.
115VAC +/-10%, 50/60Hz	F 0.5A 250V	15W
230VAC +/-10% , 50/60Hz	F 0.2A 250V (FG-7002C) F 0.25A 250V (FG-7005C)	15W

NOTE: AC Power is preset to 115V or 230V in factory according to the request of customer. AC Power can be selected inside of unit.

- Operating Environment
 TEMPERATURE : 0 °C to + 40 °C (Accuracy Specified at 23°C ± 5 °C)
 HUMIDITY : up to 85% to 40°C without temperature extremes causing condensation within the instrument.
- Storage Environment
 TEMPERATURE : -20°C to +70°C
 HUMIDITY : below 85% RH
- Overvoltage Category : CAT II,
 Performed on circuits directly connected to the low voltage installation.
- Insulation Category II: Portable equipment of local level.
- Pollution Degree : 2
- Protection to IEC 529: Ordinary

1-4. Supplied Accessories

- User's Manual ----- 1
- BNC Cable ----- 1
- Power Cord ----- 1
- Spare Fuse ----- 1

**** Specifications are subject to change without notice.**

2. INSTALLATION

2-1. Initial Inspection

This instrument was carefully inspected both mechanically and electrically before shipment. It should be physically free of damage. To confirm this, the instrument should be inspected for physical damage in transit. Also, check for supplied accessories are present and correct.

2-2. Connecting AC Power

<p style="text-align: center;">CAUTION</p> <p>AC POWER OF THIS INSTRUMENT IS PRESET TO 115V OR 230V IN FACTORY ACCORDING TO THE REQUEST OF CUSTOMER. BEFORE POWERING ON THIS INSTRUMENT, CHECK AND MAKE SURE THE VOLTAGE OF THE POWER SOURCE IS SAME WITH THE MARKING OF UNIT.</p>
--

This instrument requires 230V AC or 115V AC (50-60 Hz) power socket with protective earth contact (PE-contact). If is available only a power socket without PE-contact (so a 2-conductor ac power) then a power socket with PE-contact must be installed before or the appliance should be provided with a PE-screw-terminal which is not soluble by hand and not soluble before 2-conductor power lines.

2-3. Cooling and Ventilation

No special cooling and ventilation is required. However, the instrument should be operated where the ambient temperature is maintained.

2-4. Position

This instrument is built as a bench-type instrument with rubber feet and tilt stand in place. Stand-up angle can be adjusted by rotating angle of carrying handle.

2-5. WARMING-UP

Allow more than 30 minutes for the unit to warm up so that it is stabilized and ready for use.

3. OPERATION

3-1. Controls, indicators and connectors

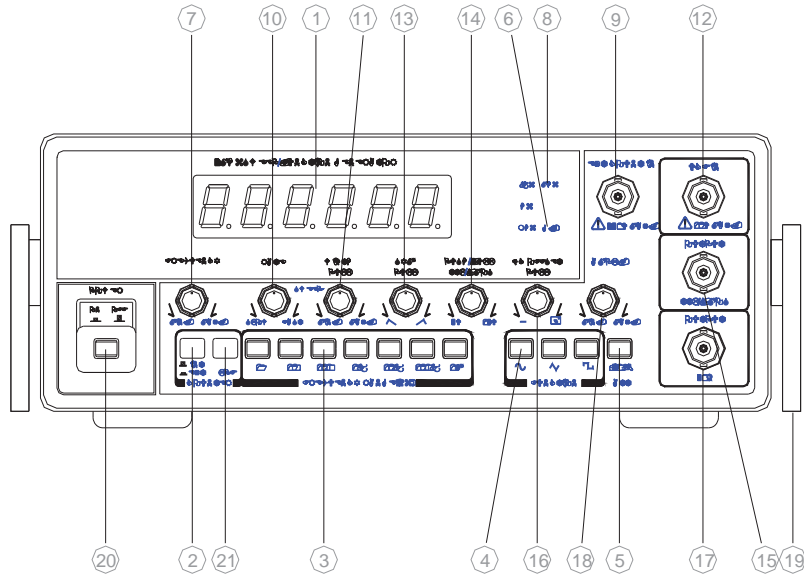

FIG 1-1. FRONT PANEL OPERATOR'S CONTROLS(FG-7002C)

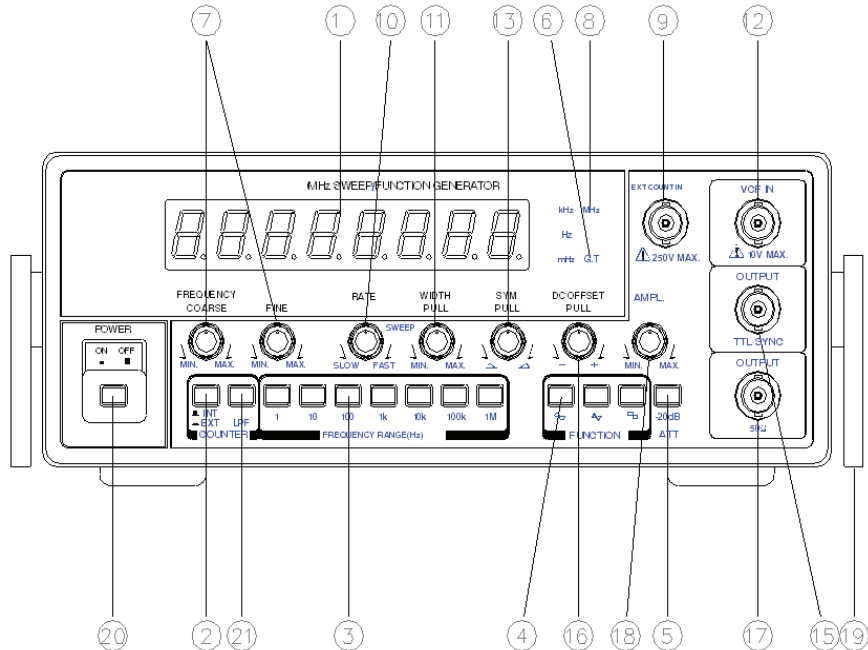

FIG 1-2. FRONT PANEL OPERATOR'S CONTROLS(FG-7005C,)

① LED DISPLAY.	Displays Internal or External Frequency.
② INTERNAL/EXTERNAL SWITCH.	PUSH IN : External Frequency Counter. PUSH OUT: Internal Frequency Counter.
③ RANGE SWITCHES.	Frequency Range Selector.
④ FUNCTION SWITCHES.	Select Sine wave, Triangle Wave Or Square Wave Output.
⑤ ATTENUATOR.	Selects Output Level By -20 dB.
⑥ GATE TIME INDICATOR.	Gate Time Is Selected Automatically By Input Signal.
⑦ FREQUENCY DIAL.(Coarse,Fine)	Controls Output Frequency in Selected Range.
⑧ MHz, KHz , Hz, mHz INDICATOR.	Indicates Unit of Frequency.
⑨ EXTERNAL COUNTER INPUT BNC.	Used as an External Frequency Counter.
⑩ SWEEP RATE CONTROL.	On-Off Switch For Internal Sweep Generator, Adjusts Sweep Rate Of Internal Sweep Generator.
⑪ SWEEP WIDTH CONTROL.	Pullout And Adjusts Magnitude Of Sweep.
⑫ VCF INPUT BNC.	Voltage Controlled Frequency Input Permits External Sweep. Frequency Control Sweep Rate Control Should Be Off When Applying External Voltage At This BNC.
⑬ SYMMETRY CONTROL.	Adjust Symmetry Of Output Waveform 1:1 to 10:1 With Push/Pull Switch On.
⑭ TTL/CMOS CONTROL.	Selects TTL Or CMOS Mode Pull-out : CMOS Level Control, Push-In: TTL Level.
⑮ TTL/CMOS OUTPUT BNC.	TTL/CMOS Level Output.
⑯ DC OFFSET CONTROLS.	Adds Positive or Negative DC Component to Output Signal.

- ① MAIN OUTPUT BNC. Impedance 50 Ohm.
- ② AMPLITUDE CONTROL. Adjusts Output Level from 0 to 20 dB.
- ③ TILT STAND. Pull Out to Adjust Tilt.
- ④ POWER SWITCH. Push type switch. turning on the power when pressed.
- ⑤ LOW PASS FILTER

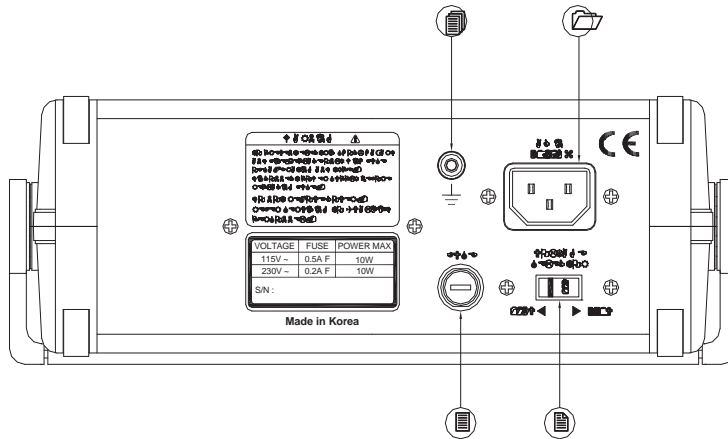

FIG 2-1. REAR PANEL(FG-7002C)

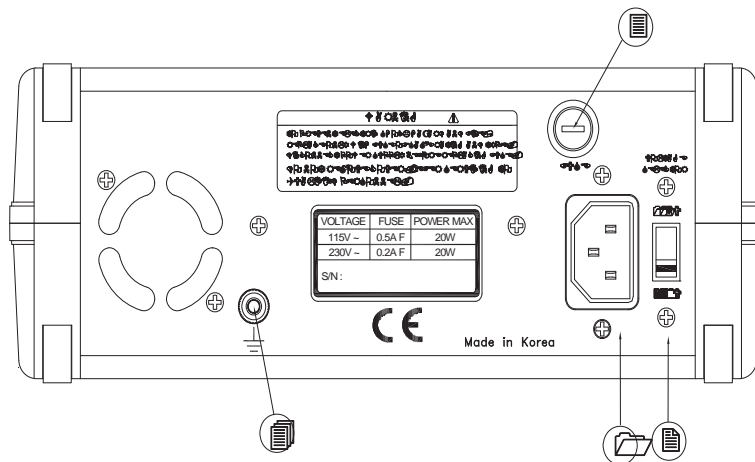

FIG 2-2. REAR PANEL(FG-7005C)

- ① AC INLET For connection of the supplied AC power
- ② Voltage Selector Switch For selecting AC Input Voltage
- ③ FUSE HOLDER. Replacing fuse with unscrewing.
- ④ Ground Terminal.

3-2. Operating instruction

This instrument is capable of generating a wide variety of waveforms and counting an external frequency with high resolution of **6 digits LED for FG-7002C (7digits LED for FG-7005C)**. The most benefit and satisfaction can be gained from the instrument by fully understanding its capabilities and versatility and becoming familiar with operation procedure. One of the best ways to initially gain this familiarization is to connect the generator to an oscilloscope. Observe the waveforms and notice the effects of the various controls on the waveforms. Use this manual as a reference until becoming accustomed to operating procedures.

3-3. Use As Function Generator.

1) Procedure

- A. Connect AC power cord into receptacle on rear panel and plug into AC inlet.
- B. To turn on equipment, push power on-off switch on.
- C. To make sure that the output is symmetrical and unaffected by the sweep generator, set the following controls as below.

CONTROLS	POSITION
Sweep width	OFF(push)
Symmetry	OFF(push)
DC offset	OFF(push)
Attenuator	RELEASE(button out)
Counter	INTERNAL(button out)

- D. To select the desired frequency, set the Range Switch and FREQ. dial as follows; The output frequency equals the FREQ. dial setting multiplied by the Range Switch setting.

For example, a FREQ. dial setting of 0.6 and a Range switch setting of 10K produces a 6 KHz output($.6 \times 10 = 6K$). A FREQ. dial setting of 2.0 and a Range switch setting of 1M produces 2 MHz output($2.0 \times 1M = 2M$).

- E. And also it can display the desired frequency by **6 digit LED display(FG-7002C) – 7digit LED display for FG-7005C.**

- F. Select sine, square, or triangle wave output by pressing the corresponding FUNCTION button. FIG 3. illustrates the output waveforms and their phase relationships.

- G. Connect a cable from the 50Ω BNC to the point where it is desired to inject the signal.
- H. Adjust the 50Ω output to the desired amplitude with the AMPLITUDE control.

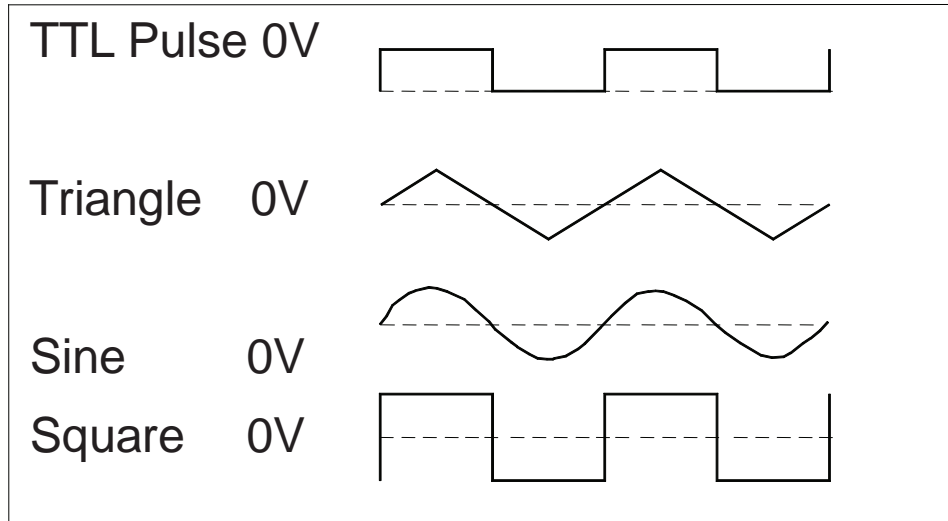

FIG. 3 OUTPUT WAVEFORMS AND PHASE RELATIONSHIPS

- I. A positive or negative DC component can be added to the signal at the 50Ω BNC by use of the DC OFFSET control, as required by the circuit into which the signal is being injected.
- J. A fixed amplitude TTL square wave is available at the TTL OUT BNC on the front panel. This signal is unaffected by the AMPLITUDE, ATTENUATOR or DC OFFSET. TTL output is a square wave for use in digital circuits, even though FUNCTION SWITCH is on sine or triangle wave.

2) Considerations

CAUTION

KNOWLEDGE OF THE FOLLOWING FACTORS IS ESSENTIAL FOR PROPER OPERATION OF THE INSTRUMENT:

- A. The DC offset control can provide over ± 10 volts open-circuited, or ± 5 volts into 50Ω load. Remember that the combined signal swing plus DC offset is also limited to ± 10 V open-circuited, or ± 5 V into 50Ω. Clipping occurs slightly next page these levels. FIG 4. illustrates the various operating conditions

encountered when using DC offset. If the desired output signal is large or if a large DC offset is used, an oscilloscope should be used to make sure that the desired combination is obtained without clipping. Keeping the Amplitude control in the lower half of its adjustment range reduces the probability of clipping.

- B. To set the DC offset to zero or a specific DC voltage, depress the Function Switches slightly so that all switches are released (all buttons out). This removes signal from the output and leaves the DC only. Measure the DC output on an oscilloscope or DC voltmeter and adjust the DC offset control for the desired value.
- C. It is easier to accurately set the FREQ. dial if settings between **0.1 and 2.0(FG-7002C), 5.0(FG-7005C)**, are used. Since the dial rotation overlaps ranges, it is not usually necessary to use readings below 1. Just change to a lower range and use a higher dial setting.

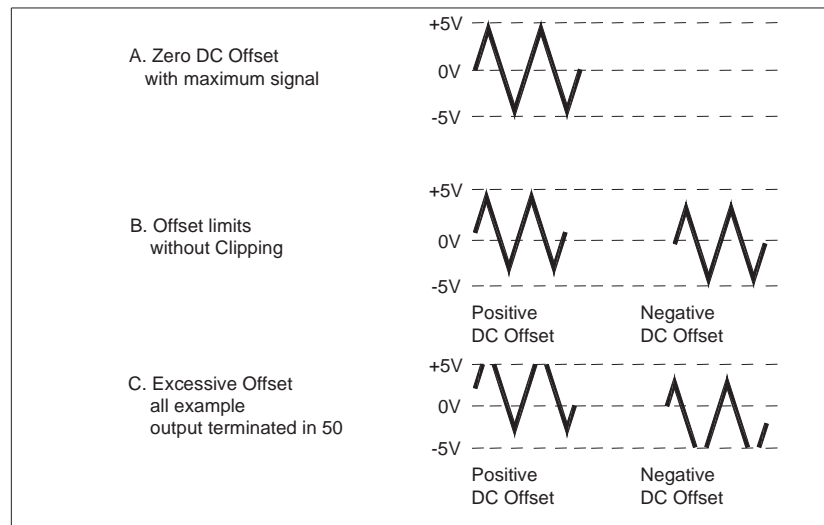

FIG 4. USE OF DC OFFSET CONTROL

- D. The main output BNC is labeled 50Ω. This means that the source impedance is 50Ω, but the output may be fed into any circuit impedance. However, the output level varies in proportion to the terminating impedance. If it is desired to maintain a constant output level while injecting signal into various circuits with various impedance, a constant terminating impedance is necessary.

When the generator output is connected to a coaxial connector on the equipment under test, it usually moderate to high impedance. A reasonably constant terminating impedance may be maintained while injecting signal into moderate and high impedance circuits(500Ω and up)by adding a coaxial tee in the output cable and connecting a 50Ω termination to one leg. Remove the 50Ω termination when injecting into a 50Ω circuit. Also keep DC injection point, the DC offset should be set to match the circuit voltage, or blocking capacitor may be required to avoid DC loading with 50Ω.

- E. When using the higher output frequencies and when using the square wave output, terminate the cable in 50Ω to minimize ringing. Keep the cables as short as possible.
- F. To set output amplitude to a specific level, measure peak to peak amplitude on an oscilloscope.

3-4. Use As Pulse Generator

In a symmetrical square wave, sine wave, or triangle wave, the positive and negative transitions are of equal time duration, or 1:1 ratio. This is the condition when the SYMMETRY control off. When the SYMMETRY control is pulled and rotated, the positive transition can be stretched in relation to the negative transition, up to at least, 10:1 ratio. Square waves can be stretched into rectangular waves or pulses, triangle waves can be stretched into distorted wave shape called a skewed sine wave. FIG 5. illustrates the types of waveforms possible and includes a summary of control settings used to obtain the desired waveform.

1)Procedure

- A. Setup generator as described for function generator operation. Display the output of generator on an oscilloscope.
- B. Select the desired type of waveform with the Function Switches. Press the square wave button for pulses, triangle button for ramp waves or sine wave button for skewed sine waves.

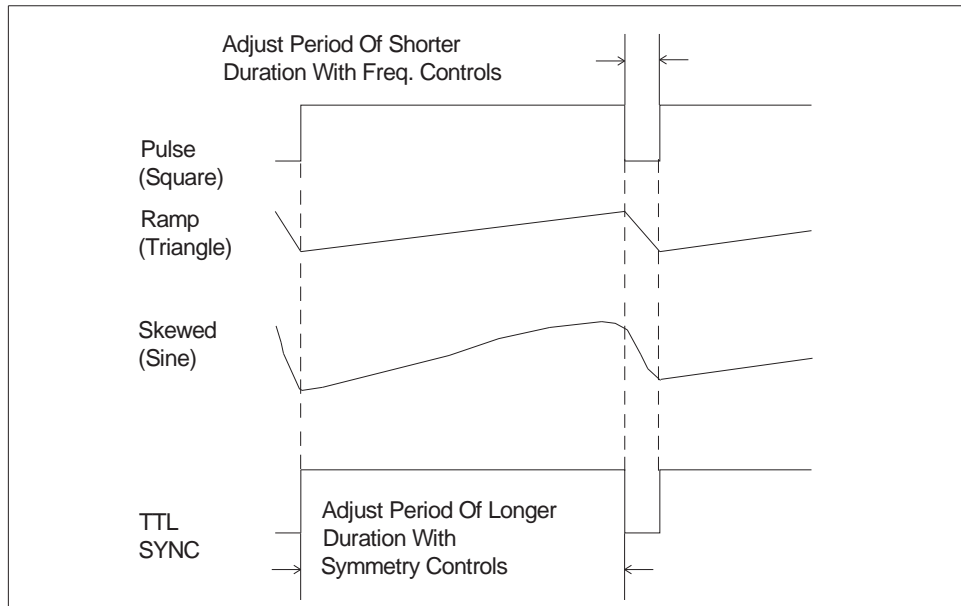

FIG 5. PULSE, RAMP, AND SKEWED SINE WAVE GENERATION

- C. If both a specific pulse width and repetition rate (specific rise time and fall time for ramp wave), are required, The waveform may be obtained as follows:
- Adjust the shorter duration portion of the waveform(pulse width for pulse, fall time for ramp waves)with the frequency controls FREQ. dial and RANGE switch.
 - Adjust the longer duration portion of the waveform(rest time for pulses, rise time for ramp waves)with the SYMMETRY control.
- D. If a specific pulse width (specific fall time for ramp wave)is not critical, but a specific repetition rate is required, the desired waveform may be obtained as follows;
- Observe the oscilloscope and adjust the SYMMETRY control to obtain the approximate desired pulse width vs. rest time ratio(rise time vs. fall time ratio for ramp waves).
 - Adjust the repetition rate with the frequency controls FREQ. dial and RANGE switch. the frequency controls affect both the pulse width and repetition rate.

2) Considerations

- A. When generating ramp waves or skewed sine waves, it may be easier to measure the time periods on oscilloscope using the square wave mode, then switch to the desired operating mode.
- B. For ease and accuracy in measurement, use a higher sweep speed on the oscilloscope to expand the pulse width for measurement, then reduce sweep speed to measure the repetition rate.
- C. Repetition rate may be expressed as a frequency or time period. Measure the repetition rate as a time period on oscilloscope and convert to frequency if required. The repetition rate includes the full cycle, both the pulse width and rest time for pulses, the rise time and fall time for ramp waves.
- D. Repetition rate can be measured accurately and easily as a frequency or time period with a frequency counter.
- E. Pulse width also can be measured on a frequency counter, but only with the SYMMETRY control set off before the pulse waveform is “stretched”. Pulse width equals one-half the time period of the square wave. If the counter is not equipped for period measurement, calculate the frequency, which is equivalent to the desired pulse width, and measure the frequency of the waveform.

$$\text{DESIRED FREQUENCY} = \frac{1}{\text{DESIRED PULSE WIDTH} \times 2}$$

3-5-1. TTL/CMOS OUTPUT(FG-7002C only)

TTL/CMOS output is specifically designed for compatibility with TTL/CMOS digital logic circuits. Set-up time is considerably reduced because the fixed logic levels and polarity are ready for direct injection into TTL/CMOS circuits. there is a need for protection from accidental Application of too high amplitude or incorrect DC offset which might damage semiconductors. Another advantage is the extremely fast rise time and fall time of signal. To use the TTL/CMOS output, connect a cable from TTL/CMOS BNC on the Front panel to the point at which it is desired to inject the signal. TL/CMOS output may be used in several modes of operation. Some examples follow.

-
- A. Using the square wave generator or pulse generator modes, clock pulses can be generated for testing, troubleshooting or circuit analysis. The instrument could even be used as a substitute master clock generator as TTL/CMOS circuits can be driven from the TTL/CMOS BNC.
 - B. The CMOS Level Control potentiometer (pull out position) provides CMOS level output from 5V to 15V Variable and Continuously. For TTL/CMOS output level, Rotate the potentiometer switch and Observe the TTL or CMOS output : Push-in is TTL, Pull-out is CMOS.

3-5-2. TTL/SYNC OUTPUT (FG-7005C only)

TTL/SYNC output is specifically designed for compatibility with TTL SYNC digital logic circuits. Set-up time is considerably reduced because the fixed logic levels and polarity are ready for direct injection into TTL SYNC circuits. there is a need for protection from accidental Application of too high amplitude or incorrect DC offset which might damage semiconductors. Another advantage is the extremely fast rise time and fall time of signal. To use the TTL SYNC output, connect a cable from TTL SYNC BNC on the Front panel to the point at which it is desired to inject the signal. TTL SYNC output may be used in several modes of operation. Some examples follow.

- A. Using the square wave generator or pulse generator modes, clock pulses can be generated for testing, troubleshooting or circuit analysis. The instrument could even be used as a substitute master clock generator as TTL SYNC circuits can be driven from the TTL SYNC BNC.

3-6. Use As FM Signal Generator

1) Procedure

- A. Set up equipment as described for function generator operation. Use the frequency and amplitude controls to set the carrier to the desired frequency and amplitude.
 - B. Connect an AC modulating signal with no DC component to the VCF IN BNC on the front panel of generator.
 - C. Adjust amplitude of the AC modulating signal for the desired frequency deviation.
-

2) Considerations

A. The approximate frequency deviation for a given VCF IN signal can be determined as follows, The 0.1 V change at the VCF IN BNC produces a frequency change of 1% of the highest frequency obtainable on a given range. For example(FG-7002C), the highest frequency obtainable on the 100 K range is 200 KHz. One percent of 200 KHz equals 2 KHz. Therefore, 0.1 V change at the VCF IN BNC will deviate the output frequency 2 KHz on the 100K range. Following table summarizes the frequency deviation versus VCF IN voltage for all ranges.

RANGE	HIGHEST FREQ. OBTAINABLE(Hz)		FREQ. DEVIATION FOR EACH 0.1 VOLT VCF IN CHANGE(Hz)	
	FG-7002C	FG-7005C	FG-7002C	FG-7005C
1	2	5	0.02	0.05
10	20	50	0.2	0.5
100	200	500	2	5
1K	2k	5k	20	50
10K	20k	50k	200	500
100K	200k	300k	2K	5k
1M	2M	5M	20K	50k

Frequency deviation versus VCF IN voltage for each model.

B. For an example(FG-7002C), it is assumed that we wish to generate a 455 KHz signal with FM deviation of ± 15 KHz (30 KHz swing). 1M range will be used to obtain the 455 KHz carrier with the FREQ. dial set to 0.455. The highest frequency obtainable on the 1M range is 2 MHz. One percent of 2 MHz is 20 KHz. Our requirement of 30 KHz deviation is 1.5 times greater than 20 KHz deviation produced by a 0.1 volt VCF IN swing, thus we will use 1.5 times as much peak-to-peak voltage swing or 0.15 V.

STATED ANOTHER WAY:

SUBSTITUTING THIS EXAMPLE:

$$\frac{\text{desired deviation}}{1\% \text{ deviation}} \times 0.1 \text{ V} = \text{required VCF IN signal} \quad \frac{30 \text{ KHz}}{20 \text{ KHz}} \times 0.1 = 1.5 \times 0.1 \text{ V} = 0.15 \text{ V}$$

C. Remember that the value of VCF IN signal is the peak to peak amplitude.

3-7. External Control Of VCF

Within a given range, the FREQ. dial setting normally controls the output frequency of generator. However, applying voltage at the VCF IN BNC on the front panel also may control it. There are three basic possible modes of external VCF control as detailed below,

- A. Applying an AC voltage produces FM modulation(Previously described in “Use as FM Signal Generator” paragraph).
- B. Applying a specific fixed DC voltage will produce a specific output frequency described in following “Programmed Frequency Selection” paragraph)
- C. Applying a ramp voltage(or other type waveform if desired)provides externally controlled sweep generator operation(described in following “Use as Externally Controlled Sweep Generator” paragraph)

The following consideration apply to all modes of operation involving external control of the VCF(voltage controlled frequency)

- A. The output frequency of generator is determined by the voltage applied to the VCF. First of all, this voltage is established by the setting of the FREQ. dial. Any voltage input drives the VCF TO A HIGHER FREQUENCY. However. The VCF can never be driven beyond its range limits (the highest and lowest frequencies that can be attained with the dial on a given range.)
- B. With the FREQ. dial set at minimum and 0 volts at the VCF in BNC, the generator output frequency is at the lower limit of the selected range. Increasing the voltage to + 10 volts drives the generator frequency to the upper limit of the range. Between 0 and + 10 Volts, the generator output frequency is proportional to the VCF IN voltage. The VCF IN voltage can be correlated to equivalent dial settings as given in Table below.

VCF voltage	Equivalent dial Setting	
	FG-7002C	FG-7005C
0	0.02	0.05
1	0.2	0.5
2	0.4	1.0
3	0.6	1.5
4	0.8	2.0
5	1.0	2.5
6	1.2	3.0
7	1.4	3.5
8	1.6	4.0
9	1.8	4.5
10	2.0	5.0

Correlation between VCF IN voltage and equivalent dial setting(dial set to Min.)

- C. The **FREQ.** dial is usually set to 0.02 when using external VCF control. This reduces the dialed VCF voltage to zero and allows the external VCF voltage to exercise complete control. It also reduces the effects of dial setting inaccuracy.
- D. If the summed dial setting and VCF IN voltage exceeds +10 volts, oscillation ceases and no output is produced. If the swing of the VCF IN signal is too great, oscillation will cease each time the instantaneous voltage reaches the limit.

3-8. Programmed Frequency Selection

A specific output frequency can be selected each time a specific VCF input voltage is applied (assuming a common dial setting). Such operation may be advantageous where there is a requirement to return to a specific frequency periodically. Eliminating the need for frequency measurement reduces set-up time and precision tuning each time frequency is needed. Just set the dial against its lower stop and turn on the external VCF voltage. Using multiple DC voltage values, which may be selected by a switch or electronic switching circuits, may program a set of two or more specific frequencies. This type of operation would be desirable in production testing where signals at several specific frequencies are required for various tests. FSK (frequency shift keying) signals also may be generated in this manner. To maintain the original accuracy each time the operation is repeated, the **FREQ.** dial must be accurately set to the same position. Probably the easiest way to assure this common dial setting is to set it against its lower stop. Additional information on programmed frequency selection is given in **APPLICATIONS** chapter of this manual.

3-9. Use As Sweep Generator

1) Procedure

- A. Set up equipment as for function generator operation.
- B. Select the highest frequency to be swept with **RANGE** switch and the lowest frequency to be swept with **FREQ.** dial.
- C. Adjust amount of sweep with the sweep rate control.
- D. Adjust repetition rate of sweep with the sweep rate control.

2) Considerations

Minimum FREQ. dial setting is recommended for most sweep generator operation. The dial setting determines the lowest frequency of generator. The sweep generator will sweep upward from that point. However, it will sweep upward only to the range limit (highest frequency to which the dial can tune on the selected range). Therefore, a low dial setting is required to obtain a sweep covering a wide frequency range. The minimum dial setting must be used to obtain the maximum sweep width of 100:1 (highest frequency sweep is 100 times that of lowest frequency swept). If a high dial setting and high SWEEP WIDTH setting are used simultaneously, the generator will sweep to the range limit and ceases operation for a portion of the sweep cycle, effectively clipping the sweep. Of course, if only a small frequency band is to be swept, a low dial setting is not important. In fact, it may be easier to set to the desired frequencies if the dial setting is 0.1 or higher.

3-10. Use As Externally Controlled Sweep Generator

A ramp voltage, or any other type waveform desired, can be applied for externally controlled sweep generator operation. 0 to 10 volt swing will sweep frequencies over a 100:1 ratio (with dial set to minimum value) Set up the instrument as described for internally controlled sweep generator operation, except turn the SWEEP WIDTH control to OFF. Apply the sweep voltage with no DC component at the VCF Input BNC. Set the FREQ. dial to the highest frequency to be swept and apply a negative-going ramp voltage.

3-11. Use As External Frequency Counter

1) USE AS EXTERNAL FREQUENCY COUNTER

A. EXTERNAL AND INTERNAL COUNTER SELECTION

This instrument can be used as a counter by Push-in of INT/EXT selection switch.

B. EXT COUNT IN BNC : accepts external frequency input.

C. COUNTER DISPLAY : Input frequency is displayed with high resolution on a 6 digit LED display.

D. mHz, Hz, KHz, MHz INDICATOR: mHz, Hz, KHz, MHz indicators & decimal points display the max. 50 MHz of external frequency.

E. PUSHED-IN FREQ.RANGE S.W X1.

-
- F. LOW PASS FILTER : If necessary, engage the LPF (low pass filter) switch. This route the input through a low pass filter (-3 dB point of approximately 100 KHz) before application to the frequency counter. This helps eliminate counting errors in low frequency measurements by minimizing effects of high frequency noise present on the input.

CAUTION

1. APPLICATION OF INPUT VOLTAGES HIGHER THAN THE LIMITS LISTED IN THE SPECIFICATIONS SECTION MAY DAMAGE THE COUNTER. BEFORE APPLYING ANY SIGNAL TO THE INPUTS, MAKE CERTAIN THAT IT DOES NOT EXCEED THESE SPECIFIED MAXIMUMS.

2. FREQUENCY COUNTER GROUND POINTS ARE CONNECTED DIRECTLY TO EARTH GROUND. ALWAYS CONNECT FREQUENCY COUNTER GROUND ONLY TO GROUND POINTS IN THE CIRCUIT UNDER TEST

NOTE

THE OVERVOLTAGE CATEGORY OF EXTERNAL FREQUENCY INPUT TERMINAL IS "CAT II". IT IS PERFORMED ON CIRCUITS DIRECTLY CONNECTED TO THE LOW VOLTAGE INSTALLATION.

4. MAINTENANCE

CAUTION

IT IS ESSENTIAL FOR SAFETY TO PROPERLY MAINTAIN AND SERVICE THIS INSTRUMENT

WARNING

VOLTAGES WITHIN THIS INSTRUMENT ARE SUFFICIENTLY HIGH TO ENDANGER LIFE. COVERS MUST NOT BE REMOVED EXCEPT BY PERSONS QUALIFIED AND AUTHORIZED TO DO SO AND THESE PERSONS SHOULD ALWAYS TAKE EXTREME CARE ONCE THE COVERS HAVE BEEN REMOVED.

4-1. Fuse replacement

- Disconnect and remove all connections from any live power source.
- Unscrew fuse holder by screw driver.
- Locate the defective fuse and remove it by gently pulling-out.
- Install a new fuse of the SAME SIZE AND RATING.
- Screwing fuse holder.

CAUTION

MAKE SURE THAT THE RATED AND SPECIFIED FUSES ARE USED FOR REPLACEMENT.

4-2. Adjustment and calibration

It is recommendable to regularly adjust and calibrate this instrument. Qualified and authorized personnel only should execute performance and procedures

4-3. Cleaning and decontamination

The instrument can be cleaned with a soft clean cloth to remove any oil, grease or grime. Never use liquid solvents or detergents. If the instrument gets wet for any reason, dry the instrument using low pressure clean air at less than 25 PSI. Use care and caution around the window cover areas where water or air could enter into the instrument while drying.

5. OTHERS

5-1. Introduction

Because of the great versatility of this Sweep/Function Generator, it would be impossible to include all of its possible applications in this manual, However ,many of the primary applications are described in detail to allow the user to adapt the procedures to other applications. The instrument has vast numbers of applications as a signal source in electronics design labs, classrooms, service shops and production facilities to test or analyze audio, radio, digital, communications, medical electronics, sonar, industrial electronics, subsonic, ultrasonic and many other electronic devices and circuits.

5-2. Troubleshooting By Signal Substitution

When troubleshooting dead audio equipment, localize the trouble by injecting an audio signal from Sweep/Function Generator to substitute for the normal signal. Starting at the nearest speaker and moving toward the audio input area, Step By Step, sound will be heard from the speaker for each stage that is operating normally. When signal is applied to the defective stage, no sound will be heard from the speaker.

CAUTION

MAKE SURE THE DC OFFSET MATCHES THE NORMAL OPERATING VOLTAGE AT EACH POINT OF SIGNAL INJECTION. IMPROPER DC OFFSET COULD BIAS A NORMALLY OPERATING STAGE TO CUT OFF AND MAKE IT APPEAR DEFECTIVE. IMPROPER DC OFFSET COULD ALSO DAMAGE CERTAIN CIRCUITS. A COUPLING CAPACITOR MAY BE USED TO BLOCK THE DC OFFSET AND ALLOW THE SIGNAL TO FLOAT AT THE DC LEVEL OF THE POINT OF INJECTION IF DESIRED.

The signal amplitude should also simulate the normal signal levels used in the circuit where signal is being injected. This technique is equally applicable to non audio equipment. Just connect an oscilloscope, voltmeter, or any other device, which will indicate the presence or absence of output. Inject the type of signal normally used by the equipment being tested. This instrument can generate almost any type of signal normally required in the frequency range (**FG-7002C:0.02Hz to 2MHz, FG-7005C: 0.05Hz to 5MHz**). If the equipment under test, It can generate unique sounds or signals by means of sweep that should be easily distinguishable from any other signals that may be present.

5-3. Troubleshooting By Signal Tracing

This technique is similar to “Troubleshooting by Signal Substitution” except that the signal is injected at the input of the equipment under test. An oscilloscope is then used to check for output at each stage, starting nearest at the input area and moving toward to the output area. Each stage, which has no output, is presumed to be defective.

5-4. Amplifier Overload Characteristics

The overload point for some amplifiers is difficult to determine by using sinewave input. The triangle waveform is ideal for this type of test because any departure from absolute linearity is readily detectable. By using the triangle output, the peak overload condition for an amplifier can be readily determined. This overload condition is shown in shown in FIG 6.

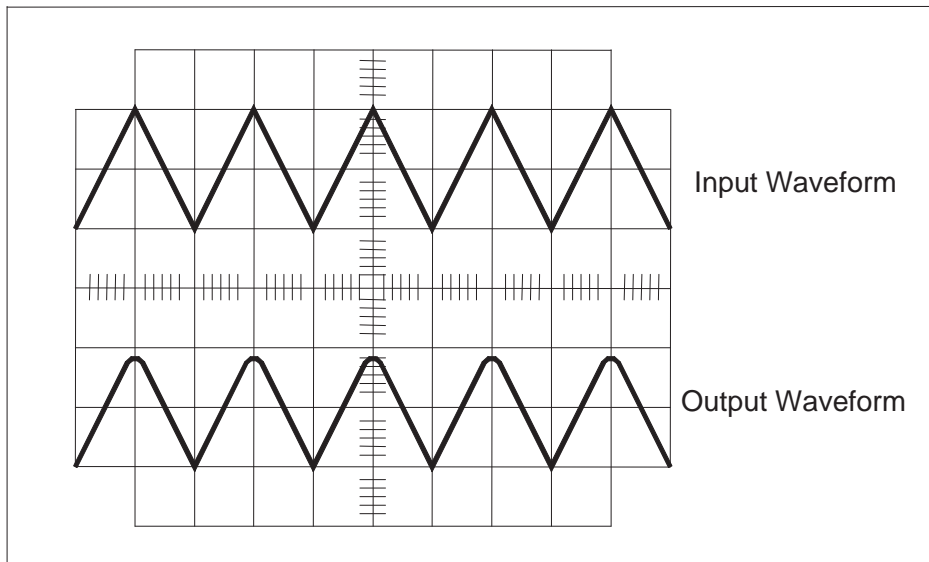

FIG 6. Amplifier overload characteristics

5-5. Amplifier Performance Evaluation Using Square Waves

The standard sinewave frequency response curves do not give a full evaluation of the amplifier transient response. The square wave, because of the high harmonic content, yields much information regarding amplifier performance when used in conjunction with an oscilloscope.

- A. Use the test set-up of FIG 7. The 50Ω termination at the amplifier input is essential when using square waves to eliminate the ringing effects generated by the fast rise times.
- B. Using the triangle output, set the AMPLITUDE control so that there is no signal clipping over the range of frequencies to be used.
- C. Select the square wave output and adjust the frequency to several check points within the pass band of the amplifier such as 20 Hz, 1000 Hz and 10 KHz.
- D. At each frequency checkpoint, the waveform obtained at the amplifier output provides information regarding amplifier performance with respect to the frequency of square wave input. FIG 7. indicates the possible waveforms obtained at the amplifier output. Square wave evaluation is not practical for narrow-band amplifiers. The restricted bandwidth of the amplifier cannot reproduce all frequency components of the square wave in the proper phase and amplitude relationships.

Square Wave Selected

Dual Trace Oscilloscope Preferred

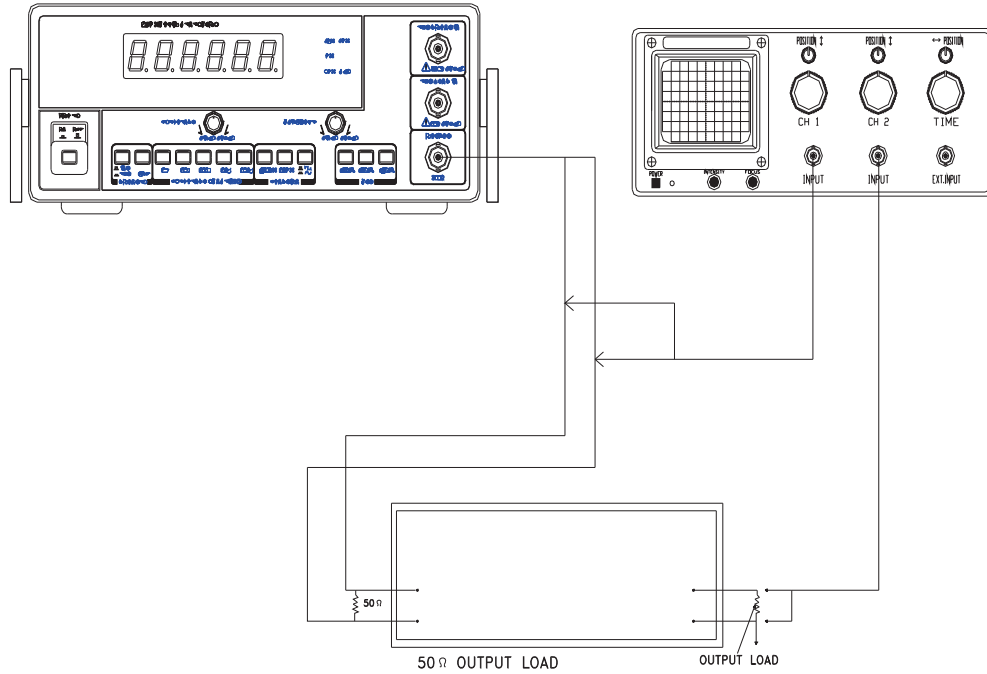

A. Test Waveforms

B. Test Waveforms

<p>1 FREQUENCY DISTORTION (AMPLITUDE REDUCTION OF LOW FREQUENCY COMPONENT) NO PHASE SHIFT</p>	<p>2 LOW FREQ. BOOST (ACCENTUATED FUNDAMENTAL)</p>	<p>3 HIGH FREQUENCY LOSS NO PHASE SHIFT</p>
<p>4 LOW FREQUENCY PHASE SHIFT</p>	<p>5 LOW FREQUENCY LOSS AND PHASE SHIFT</p>	<p>6 HIGH FREQUENCY LOSS AND LOW FREQUENCY PHASE</p>
<p>7 HIGH FREQUENCY LOSS AND PHASE SHIFT</p>	<p>8 DAMPED OSCILLATION</p>	<p>9 LOW FREQUENCY PHASE SHIFT (TRACE THICKENED BY HUM VOLTAGE)</p>

FIG 7. AMPLIFIER PERFORMANCE EVALUATION USING SQUARE WAVES.

A. Test Set-up

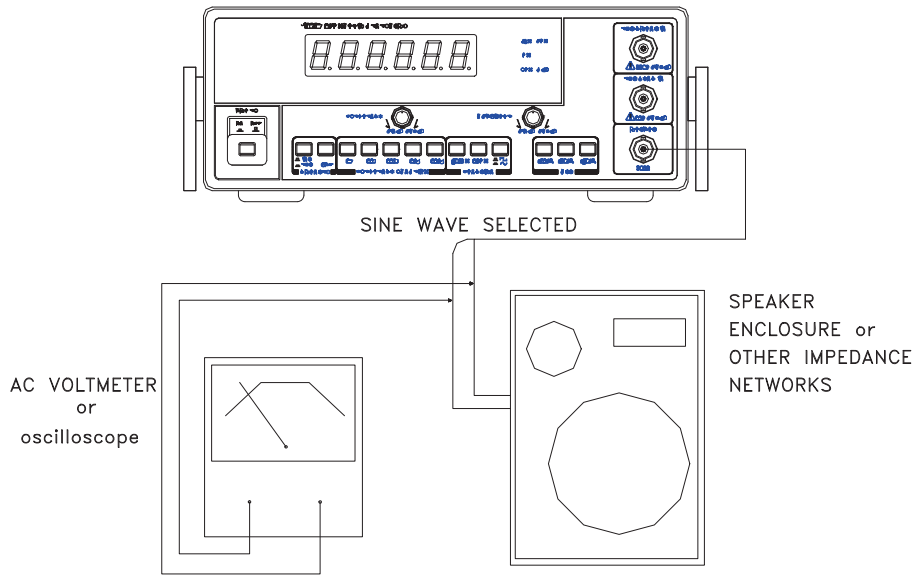

B. Equivalent Circuit Of Test Set-Up

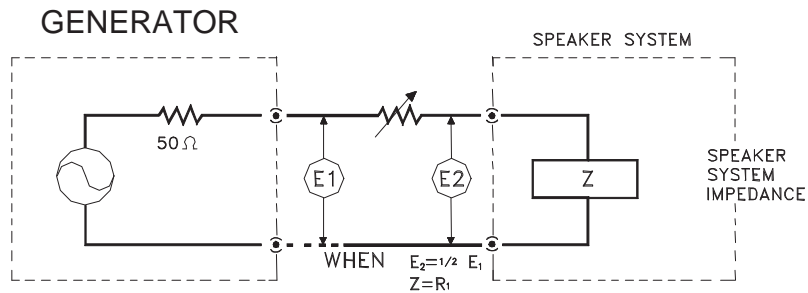

C. Graph Of Results

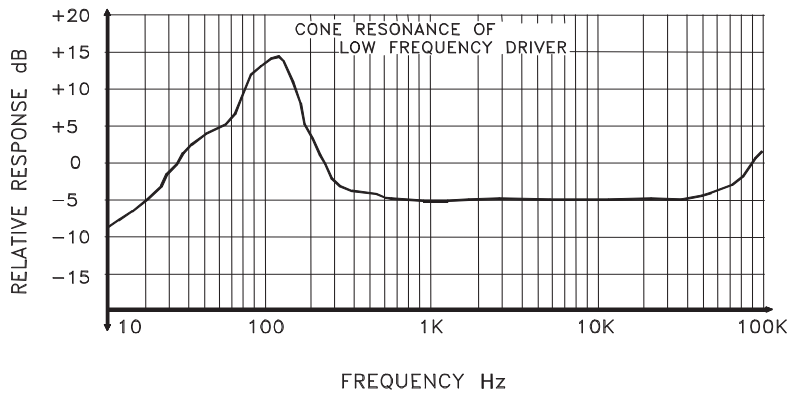

FIG 8. TESTING SPEAKER SYSTEMS AND IMPEDANCE NETWORKS.

5-6. Testing Speakers and Impedance Networks

This instrument can be used to provide information regarding the input impedance of a speaker or any other impedance network vs. frequency. In addition, the resonant frequency of the network can be determined.

- A. Connect equipment as shown in Test Set-Up in FIG. 8 for frequency response measurement except that the signal input to the speaker or impedance network is monitored. The oscilloscope may be used to verify that this instrument is not in a clipping condition.
- B. If the voltmeter method is used, vary the range over the full range of interest and log the voltage measured at the speaker terminals vs. Frequency. The dB scales of the AC voltmeter are convenient for converting this information to standard response units.
- C. If the oscilloscope method is used, use sweep operation as for frequency response measurement.
- D. In speaker testing, a pronounced increase of voltage will occur at some low frequency. This is the resonance frequency of the speaker systems(FIG. 8). The speaker enclosure will modify the results obtained from the same speaker without an enclosure. A properly designed enclosure will produce a small peak on each side of the peak obtained without an enclosure. the enclosure designer can use the response characteristics to evaluate the effects of varying port sizes, damping materials and other basic enclosure factors.
- E. In testing other impedance networks resonance will not necessarily occur at low frequency. However, as resonance is approached the signal level will increase. The impedance of the network can be measured at resonance, or at other frequencies if desired as follows:
 - 1) Connect a variable resistor in series with the impedance network as shown in FIG. 8
 - 2) Measure the voltage at points E1 and E2 respectively and adjust variable resistor R1 so that voltage E2 equals one half of voltage E1

5-7. Digital Frequency Selection

Frequencies can be switched electronically by using the set-up shown in FIG. 9. The preset voltages can be digitally selected and applied to the VCF IN BNC. Although provision for two frequencies are shown, additional frequencies can be added using redundant circuits. This is convenient in frequency shift keying (FSK) systems.

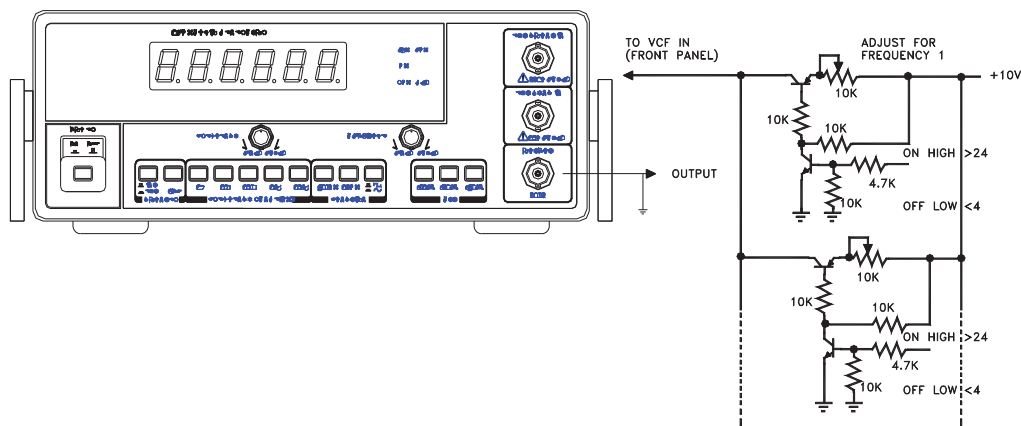

FIG 9. DIGITALLY PROGRAMMED FREQUENCY SELECTION

5-8. Additional Applications

The triangle or ramp output of this instrument can be used at its lowest frequencies to simulate a slowly varying DC source. This can be used to check threshold levels of TTL and CMOS logic as well as voltage comparators can be exercised from zero to full scale to observe defective deflection such as sticky meter movements.



This is marking shown on the product or its literature, indicates that it should not be disposed with other household wastes at the end of its working life.

To prevent possible harm to the environment or human health from

 uncontrolled waste disposal, please separate this from other types of wastes and recycle it responsibly to promote the sustainable reuse of material resources.

Household users should contact either the retailer where they purchased this product, or their local government office, for details of where and how they can take this item for environmentally safe recycling.

Business users should contact their supplier and check the terms and conditions of the purchase contract.

This product should not be mixed with other commercial wastes for disposal.

 **EZ Digital Co.,Ltd.**

1.800.561.8187

www.**itm**.com

information@itm.com