

E30 & E31 SERIES

Monitor Entire Panelboards with One Device



E3xA/B/C



E3xE

Integrated Ethernet with SNMP, BACnet, & Modbus

The E30 & E31 Series Panelboard Monitoring System provides a cost effective solution for electrical load management, making it ideally suited for applications where loads are dynamic, such as the data storage industry, lighting panels, etc.

The E30 & E31 Series monitors the current, voltage, instantaneous power, demand, and energy consumption of each circuit in a panelboard including the main feed.* As a circuit approaches the user-configured thresholds, alarm indicators are triggered, preventing costly downtime from overloaded circuits or failed loads. (See graph, facing page).

* E3xB/C models have less capability.

SPECIFICATIONS

INPUTS	
Input Power	E3xA/B/C: 90 to 277 Vac line-to-neutral, 50/60 Hz, 8 VA E3xE: 100 to 277 Vac line-to-neutral, 50/60 Hz, 15 VA
ACCURACY	
Power/Energy	IEC 62053-21 Class 1, ANSI C12.1-2008. 1% system accuracy (includes main board and 50 A or 100 A branch CTs)
Voltage	±0.5% of reading 90 to 277 Vac line-to-neutral
Current	±0.5% of reading
Minimum ON Current	50 mA
OPERATION	
Sampling Frequency	2560 Hz
Update Rate	2 seconds (both panels)
Overload Capability	22 kAIC
OUTPUTS	
Serial Protocols	All: Modbus RTU E3xE models: BACnet MSTP
Serial Connection	All: 2-wire, RS-485 E3xA/B/C models: 4-wire RS-485
Address	E3xA/B/C models: Selectable address 1 to 247 (uses 2 addresses for Modbus RTU) E3xE models: Selectable at address 1 to 247 for Modbus RTU; 0 to 127 for BACnet MS/TP
Baud Rate	All: 9600, 19200, 38400 (selectable on A/B/C models)

Revenue grade

ANSI and IEC Class 1 metering system accuracy including branch CTs

50 mA to 100 A

Widest dynamic range in the industry, 50 mA to 100 A monitoring

Versatility

Flexible installation with 3/4", 1", or 18 mm spaced solid-core branch CT strips

Retrofit or new construction

New construction and retrofit applications with solid-core and split-core CT models

Up to 92 Channels

Monitor up to 92 circuits per unit providing unlimited possibilities for monitoring

Configure the meters you want

Choose 4, 8, 14 or 28 3-phase meters. User-configurable to any combination of 1-, 2-, 3-phase meters. Reconfigure channels as needed to monitor neutral current.

APPLICATIONS

- Load-based cost allocation
- Overload protection
- Data center PDUs
- Sub-tenant billing
- Lighting control panels
- Load management
- Load balancing
- Energy management

Parity	All: Modbus RTU: NONE, ODD, EVEN (selectable on A/B/C models) E3xE models: BACnet MS/TP: NONE (fixed)
Terminal Block Torque	4.4 to 5.3 in-lb (0.5 to 0.6 N-m)
Ethernet Protocols	All: Modbus TCP E3xE models: BACnet IP, SNMP V2c
Ethernet Connection	E3xE models only: RJ-45 10/100 Mbit
ENVIRONMENTAL	
Operating Range	0 to 60 °C (32 to 140 °F) (<95% RH non-condensing)*
Storage Temp Range	-40 to 70 °C (-40 to 158 °F)
Altitude of Operation	3000 m
WARRANTY	
Limited Warranty	5 years
AGENCY APPROVALS	
Agency Approvals	UL508, EN61010-1, Cat. III, pollution degree 2
Type Approval***	California Code of Regulations, Title 4, Division 9, Article 1. National Uniformity Exceptions and Additions, 2016 edition



* Indoor use only.

**The CE mark indicates RoHS2 compliance. Please refer to the CE Declaration of Conformity for additional details.

***E30xxx (solid-core) models only.

PRODUCT CAPABILITIES

	E3xA	E3xB	E3xC	E3xE
MONITORING AT MAINS				
Current per phase	•	•	•	•
Max. current per phase	•	•	•	•
Current demand per phase	•	•	•	•
Max. current demand per phase	•	•	•	•
Current phase angle	•	•		•
Energy (kWh) per phase	•	•		•
Real Power (kW) per phase	•	•		•
Apparent Power (kVA)	•	•		•
Power factor total*	•	•		•
Power factor per phase	•	•		•
Voltage, L-L and average	•	•		•
Voltage, L-N and average	•	•		•
Voltage, L-N and per phase	•	•		•
Frequency (phase A)	•	•		•
MONITORING AT BRANCH CIRCUIT				
Current	•	•	•	•
Max. current	•	•	•	•
Current demand	•	•	•	•
Max. current demand	•	•	•	•
Current phase angle	•			•
Real power (kW)	•			•
Real power (kW) demand	•			•
Real power (kW) demand max.	•			•
Energy (kWh) per circuit	•			•
Power factor	•			•
Apparent Power (kVA)	•			•
MODBUS ALARMS				
Voltage over/under	•	•		•
Current over/under	•	•	•	•
PROTOCOLS SUPPORTED				
Modbus RTU	•	•	•	•
Modbus TCP	**	**	**	•
BACnet MS/TP	†	†	†	•
BACnet IP with BBMD support	†	†	†	•
SNMP V2	‡	‡	‡	•

* Based on a 3-phase breaker rotation.
 ** With UO13-0012 or E8951 added.
 † With E8951 added.
 ‡ With E8951 added; requires one E8951 for each meter.

E30A/B/C & E31A/B/C MAIN BOARD

Dimensional Drawing

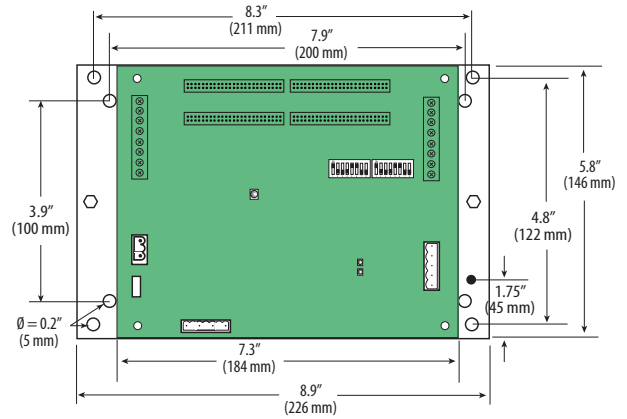

E30E & E31E

Dimensional Drawing

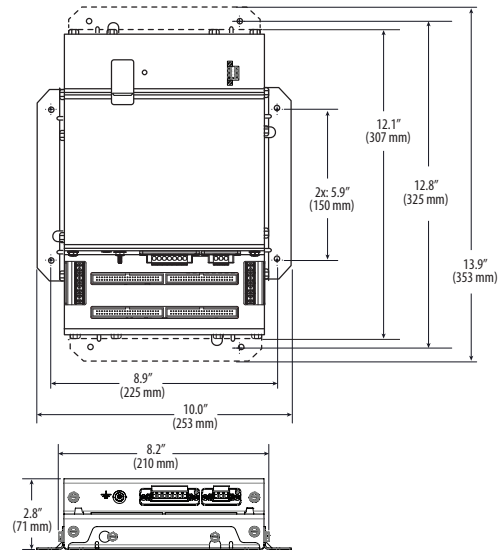

OPERATION EXAMPLE

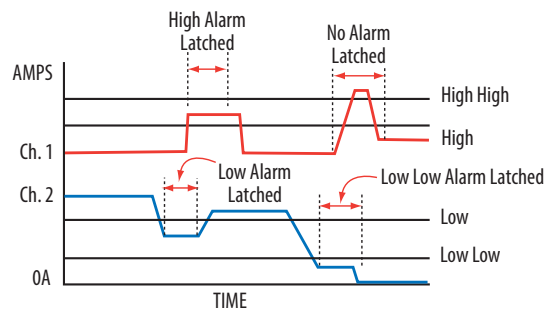

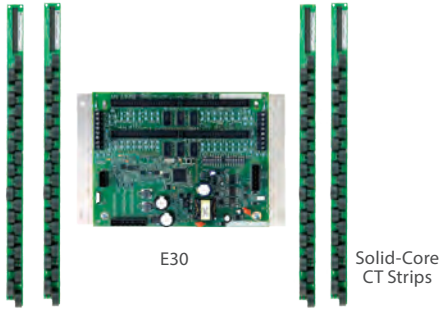

PANELBOARD
Wiring Diagram

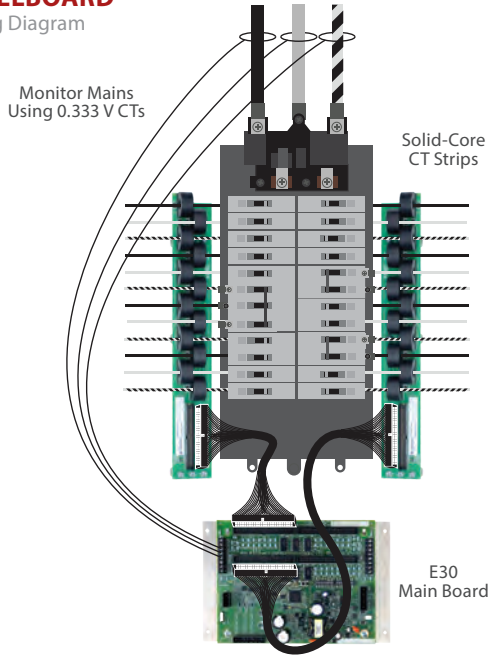

SOLID-CORE BRANCH CTs

	100 A SOLID-CORE BRANCH CT
Voltage Rating	300 Vac
Temperature	0 to 60 °C
Agency	EN61010-1

ATTENTION
Observe precautions for handling static sensitive devices to avoid damage to the circuitry that is not covered under the factory warranty.

E30 (SOLID-CORE) ORDERING INFORMATION

Description	Branch CT Spacing	# of Branch CTs & Ribbon Cables
E30 <input type="checkbox"/>	<input type="checkbox"/>	<input type="checkbox"/>
A = Advanced	0 = 100 A, 3/4" spacing	24 = 2 strips of 12 branch CTs (18 mm only) and two 4-ft. round ribbon cables
B = Intermediate	1 = 100 A, 1" spacing	36 = 2 strips of 18 branch CTs (18 mm only) and two 4-ft. round ribbon cables
C = Basic	2 = 100 A, 18 mm spacing	42 = 2 strips of 21 branch CTs (3/4", 1", or 18 mm) and two 4-ft. round ribbon cables
E = Advanced w/Ethernet		48 = 4 strips of 12 branch CTs (18 mm only) and four 4-ft. round ribbon cables
		72 = 4 strips of 18 branch CTs (18 mm only) and four 4-ft. round ribbon cables
		84 = 4 strips of 21 branch CTs (3/4", 1", or 18 mm) and four 4-ft. round ribbon cables

Example:

E30 A 0 42

NOTE: CTs for mains (not used on E3xC models) must be ordered separately. Use 0 to 0.333V CTs rated for use with Class 1 voltage inputs.

BRANCH CT STRIPS
Dimensional Drawing

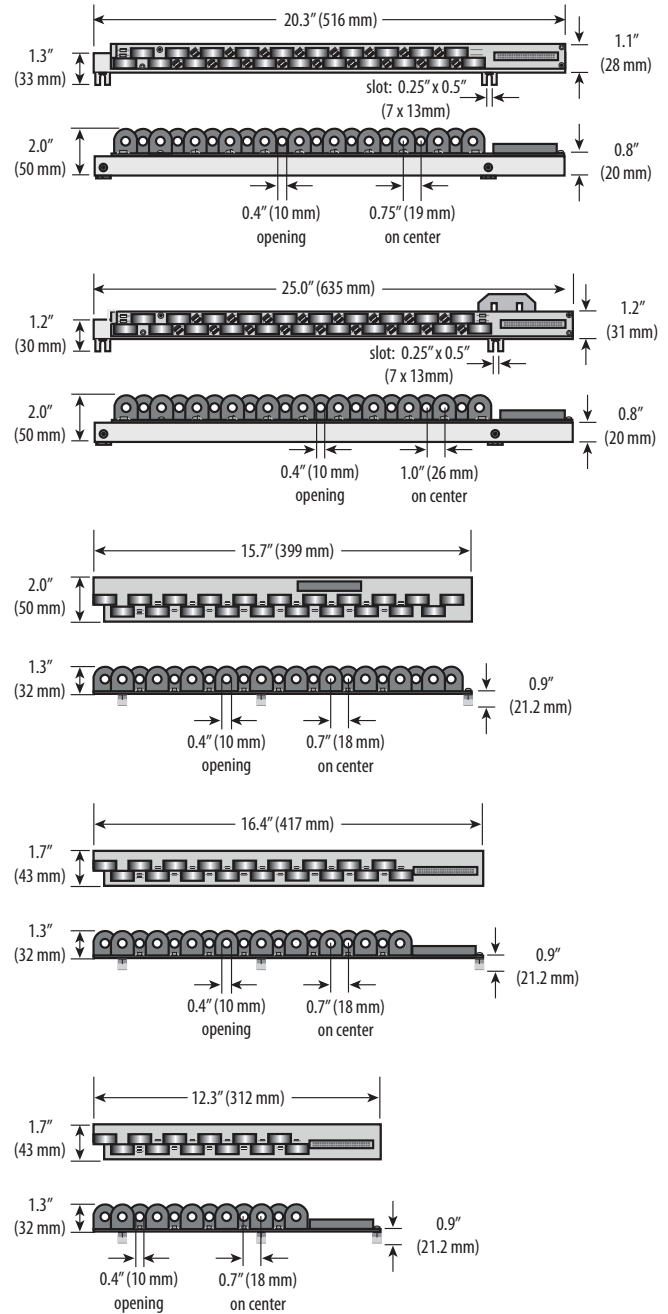

Consult factory for additional mounting options.

E31 (SPLIT-CORE) ORDERING INFORMATION

1 Boards

Description	# of CTs
E31	
A = Advanced board	002 = 2 adapter boards, no CTs, no cables
B = Intermediate board	004 = 4 adapter boards, no CTs, no cables
C = Basic board	42 = 2 adapter boards, 42 50A CTs, 2 4 ft. round ribbon cables
E = Advanced with Ethernet	84 = 4 adapter boards, 84 50A CTs, 4 4 ft. round ribbon cables
	Y63 = 2 adapter boards, flat ribbon cables, pre-assembled on one bracket, CTs not included (not available with E31E models)

2 Branch CTs (up to 21 CTs per adapter board)

Description	
E31CT	
0 = 6-pack, 50A Branch CT, 6 ft. (1.8 m) lead	3 = Single CT, 200A Branch CT, 6 ft. (1.8 m) lead
OR20 = 6-pack, 50A Branch CT, 20 ft. (6 m) lead	
1 = 6-pack, 100A Branch CT, 6 ft. (1.8 m) lead	3R20 = Single CT, 200A Branch CT, 20 ft. (6 m) lead
1R20 = 6-pack, 100A Branch CT, 20 ft. (6 m) lead	

3 Ribbon Cable (order 1 cable per adapter board)

Description	
CBLO	
34 = Round Ribbon Cable, 1 ft. (0.3 m)	08 = Flat Ribbon Cable, 18 in. (0.5 m)
31 = Round Ribbon Cable, 18 in. (0.5 m)	16 = Flat Ribbon Cable, 4 ft. (1.2 m)
32 = Round Ribbon Cable, 30 in. (0.8 m)	17 = Flat Ribbon Cable, 5 ft. (1.5 m)
22 = Round Ribbon Cable, 4 ft. (1.2 m)	18 = Flat Ribbon Cable, 6 ft. (1.8 m)
33 = Round Ribbon Cable, 8 ft. (2.4 m)	19 = Flat Ribbon Cable, 8 ft. (2.4 m)
23 = Round Ribbon Cable, 10 ft. (3 m)	20 = Flat Ribbon Cable, 10 ft. (3 m)
24 = Round Ribbon Cable, 20 ft. (6 m)	21 = Flat Ribbon Cable, 20 ft. (6 m)

Ordering Examples:

Option A: For monitoring 42 or 84 circuits, order a pre-made kit from Group 1 only (see Application/Wiring Diagram above). Example: E31x42 or E31x84
 Option B: For monitoring other configurations, build your own kit by selecting from Groups 1, 2, and 3.

Example kit for an 18-circuit panel retrofit:

- 1 E31A002 - Advanced board, 2 adapter boards (1 unit)
- 2 E31CT0 - 50A Branch CT six-pack (3 units)
- 3 CBL023 - 10 ft. round ribbon cable (2 units)

NOTE: CTs for mains (not used on E3xC models) must be ordered separately. Use 0 to 0.333 V CTs rated for use with Class 1 voltage inputs.

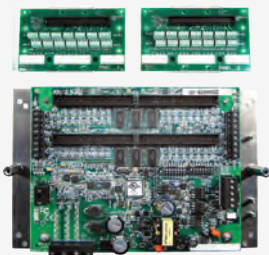

E31



E31xY63

SPLIT-CORE BRANCH CTs

	50 A SPLIT-CORE BRANCH CT	100 A SPLIT-CORE BRANCH CT	200 A SPLIT-CORE BRANCH CT
Voltage Rating	300 Vac	300 Vac (CE), 600 Vac (UL)	300 Vac (CE), 600 Vac (UL)
Measurement Range	0 to 60 A	0 to 120 A	0 to 240 A
Temperature	0 to 60 °C	0 to 60 °C	0 to 60 °C
Agency	UL 61010-1 Recognized, EN61010-1	UL 61010-1 Recognized, EN61010-1	UL 61010-1 Recognized, EN61010-1

E31 ADAPTER BOARD

Dimensional Drawing

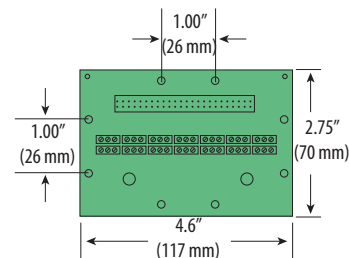

BRANCH CTs

Dimensional Drawing

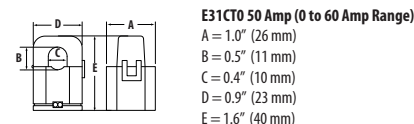

E31CT0 50 Amp (0 to 60 Amp Range)

- A = 1.0" (26 mm)
- B = 0.5" (11 mm)
- C = 0.4" (10 mm)
- D = 0.9" (23 mm)
- E = 1.6" (40 mm)

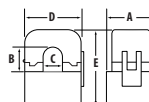

E31CT1 100 Amp (0 to 120 Amp Range)

- A = 1.5" (39 mm)
- B = 0.8" (20 mm)
- C = 0.7" (16 mm)
- D = 1.6" (40 mm)
- E = 2.1" (53 mm)

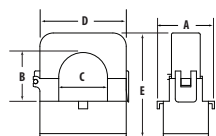

E31CT3 200 Amp (0 to 240 Amp Range)

- A = 1.5" (39 mm)
- B = 1.25" (32 mm)
- C = 1.25" (32 mm)
- D = 2.5" (64 mm)
- E = 2.8" (71 mm)

E31XY63 BOARDS WITH BRACKET

Dimensional Drawing

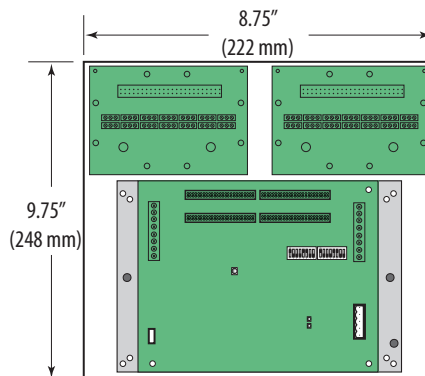

WIRING DIAGRAM

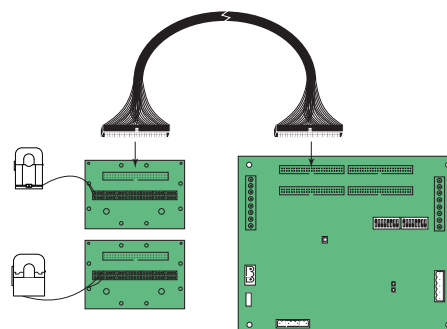

Observe precautions for handling static sensitive devices to avoid damage to the circuitry that is not covered under the factory warranty.