



USER MANUAL

## FLIR MODEL CM275

Imaging Clamp Meter with IGM™ and Bluetooth®



## ***Table of Contents***

---

<b>1. ADVISORIES</b>	<b>5</b>
1.1 Copyright	5
1.2 Quality Assurance	5
1.3 Documentation	5
1.4 Disposal of Electronic Waste	5
<b>2. SAFETY</b>	<b>6</b>
<b>3. INTRODUCTION</b>	<b>8</b>
3.1 Key Features	8
<b>4. METER DESCRIPTION</b>	<b>9</b>
4.1 Front and Back Meter Descriptions	9
4.2 Function Switch Positions	10
4.3 Function Buttons and Selector/Navigation Pad	10
4.3.1 MODE Button Sequence of Operations	11
4.3.2 Navigation Pad/OK Button	11
4.4 Status Bar Display Icons	11
4.5 Other Display Icons	12
<b>5. METER POWER</b>	<b>13</b>
5.1 Powering the Meter	13
5.2 Auto Power OFF (APO)	13
5.3 Battery Type Selection	13
<b>6. MENU SYSTEM</b>	<b>14</b>
6.1 Using the Menu System	14
6.2 Main Menu Options	14
6.2.1 Image Mode	14
6.2.2 Thermal Settings Menu	14
6.2.3 Gallery Mode	15
6.2.4 Advanced Functions Menu	15
6.2.5 General Settings Menu	15
<b>7. GENERAL SETTINGS</b>	<b>16</b>
7.1 General Settings Navigation	16
7.1.1 Diode SMART/CLASSIC	16
7.1.2 APO (Auto Power OFF)	16
7.1.3 Datalogger Sample Rate	16
7.1.4 Real-time Clock	16
7.1.5 Battery Selection	17
7.1.6 Bluetooth® ON/OFF	17
7.1.7 Button-press tone ON/OFF	17
7.1.8 Language selection	17

7.1.9 Delete all Datalogger readings	17
7.1.10 Delete all Stored Images	17
7.1.11 View HELP Screen	17
7.1.12 Viewing meter component information	17
<b>8. THERMAL IMAGING</b>	<b>18</b>
8.1 Thermal Imager Basics	18
8.2 Thermal Imager Operation	19
8.3 Thermal Settings Menu (Color Palette, Emissivity, Temperature Units, Laser Pointer, Crosshairs)	20
8.4 Image Mode Menu	21
8.5 Image Capture	21
8.6 Image Freeze (Data Hold)	21
<b>9. CLAMP METER OPERATION</b>	<b>22</b>
9.1 Auto/Manual Range Mode	22
9.2 Out-of-range Warning (OL)	22
9.3 Data Hold	22
9.4 VFD Mode (Low Pass Filter)	22
9.5 MAX-MIN Mode	23
9.6 DCA Zero Mode	23
9.7 Datalogger	23
9.8 Current and Frequency Measurements	25
9.9 Clamp Adaptor (FLEX) Current and Frequency Measurements	26
9.10 Inrush Current Measurements	27
9.11 Voltage, Lo Z, and Frequency Measurements	28
9.12 Resistance Measurements	29
9.13 Continuity Test	29
9.14 Classic Diode Test	30
9.15 Smart Diode Test	31
9.16 Capacitance Measurements	32
<b>10. BLUETOOTH® COMMUNICATION</b>	<b>33</b>
<b>11. APPENDICES</b>	<b>34</b>
11.1 Emissivity Factors for Common Materials	34
11.2 Non-Uniformity Correction	34
11.3 Infrared Energy and Thermal Imaging Overview	35
<b>12. MAINTENANCE</b>	<b>36</b>
12.1 Cleaning and Storage	36

12.2 Battery Replacement	36
12.3 Disposal of Electronic Waste	36
<b>13. SPECIFICATIONS</b>	<b>37</b>
13.1 General specifications	37
13.2 Thermal Imaging Specifications	38
13.3 Electrical Specifications	39
<b>14. TECHNICAL SUPPORT</b>	<b>43</b>
<b>15. WARRANTY</b>	<b>44</b>

## 1. Advisories

---

### 1.1 Copyright

© 2020, FLIR Systems, Inc. All rights reserved worldwide. No parts of the software including source code may be reproduced, transmitted, transcribed or translated into any language or computer language in any form or by any means, electronic, magnetic, optical, manual or otherwise, without the prior written permission of FLIR Systems.

The documentation must not, in whole or part, be copied, photocopied, reproduced, translated or transmitted to any electronic medium or machine-readable form without prior consent, in writing, from FLIR Systems.

Names and marks appearing on the products herein are either registered trademarks or trademarks of FLIR Systems and/or its subsidiaries. All other trademarks, trade names or company names referenced herein are used for identification only and are the property of their respective owners.

### 1.2 Quality Assurance

The Quality Management System under which these products are developed and manufactured has been certified in accordance with the ISO 9001 standard.

FLIR Systems is committed to a policy of continuous development; therefore, we reserve the right to make changes and improvements on any of the products without prior notice.

### 1.3 Documentation

To access the latest manuals and notifications, go to the Download tab at:

[area](#) you will also find the latest releases of manuals for our other products, as well as manuals for our historical and obsolete products.

### 1.4 Disposal of Electronic Waste



As with most electronic products, this equipment must be disposed of in an environmentally friendly way, and in accordance with existing regulations for electronic waste.

Please contact your FLIR Systems representative for more details.

## 2. Safety

---

### Safety Notes

- Before operating the device, you must read, understand, and follow all instructions, dangers, warnings, cautions, and notes.
- FLIR Systems reserves the right to discontinue models, parts or accessories, and other items, or to change specifications at any time without prior notice.
- Remove the batteries if the device is to be stored for an extended period.



### Warning Statements

- Do not operate the device if you do not have the correct knowledge. Incorrect operation of the device can cause damage, shock, injury or death to persons.
- Do not start a measuring procedure before you have set the function switch to the correct position. Failure to do so can cause damage to the instrument and can cause injury to persons.
- Do not change to the resistance mode when measuring voltage. This can cause damage to the instrument and can cause injury to persons.
- Do not measure the current on a circuit when the voltage increases to more than 1000 V. This can cause damage to the instrument and can cause injury to persons.
- You must disconnect the test leads from the circuit under test before you change the range. Failure to observe this warning can damage the instrument and cause bodily injury.
- Do not replace the batteries before you remove the test leads. This can cause damage to the instrument and can cause injury to persons.
- Do not use the device if the test leads and/or the device show signs of damage. Injury to persons can occur.
- Be careful performing measurements if the voltages are > 25 VAC rms or 35 VDC. There is a risk of shock from these voltages. Injury to persons can occur.
- Do not do diode, resistance or continuity tests before you have removed the power from capacitors and other devices under test. Injury to persons can occur.
- Be careful when performing voltage checks on electrical outlets. These checks are difficult because of the uncertainty of the connection to the recessed electrical contacts. You must not rely solely on this device when determining if the terminals are not "live". There is a risk of electrical shock. Injury to person can occur.
- Do not touch expired/damaged batteries without gloves. Injury to persons can occur.
- Do not cause a short circuit of the batteries. This can cause damage to the instrument and can cause injury to persons.
- Do not put the batteries into a fire. Injury to persons can occur.
- Use extreme caution when the laser pointer is on.
- Do not point the beam toward anyone's eye or allow the beam to strike the eye from a reflective surface.
- Do not use the laser near explosive gases or in other potentially explosive areas.
- Refer to the CAUTION statement label (shown below) for critical safety information.

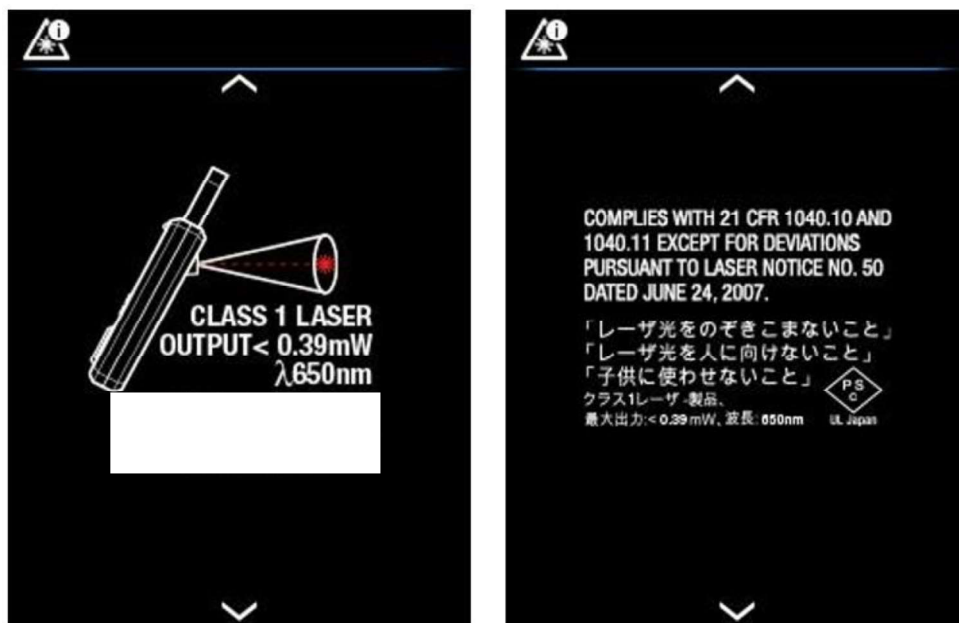

Fig. 2.1 Laser Safety Information

### Cautions

Do not use the device in a manner not specified by the manufacturer. This can cause damage to the protection provided.

	<p>This symbol, adjacent to another symbol or terminal, indicates that the user must refer to the user manual for further information.</p>
	<p>This symbol, adjacent to a terminal, indicates that, under normal use, hazardous voltages may be present.</p>
	<p>Double insulation.</p>



UL listing is not an indication or a verification of the accuracy of the meter

### 3. Introduction

---

Thank you for selecting the FLIR CM275 Imaging Clamp meter with IGM™ (Infrared Guided Measurement) and Bluetooth®. The CM275 is a True RMS 600A AC/DC clamp meter with a radiometric Lepton Thermal Imaging system, integrated VFD Mode, Inrush Current capture, a Lo Z mode for eliminating 'ghost' voltages, Bluetooth® communications capabilities, and many others as listed in the Key Features section below. This device is shipped fully tested and calibrated and, with proper use, will provide years of reliable service.

#### 3.1 Key Features

- 6000 count digital TFT display with bargraph
- Built-in Infrared Imager with gallery mode for storing, viewing, and transmitting images via Bluetooth®
- Capture fully radiometric thermal images where a temperature measurement is saved for each display pixel
- Imager features Laser pointer, cross hairs targeting, and an intuitive menu system
- High power work lights built-in
- Auto Range True RMS AC/DC 600 A capability
- Auto Range True RMS AC/DC 1000 V capability
- Frequency AC bandwidth (45-400Hz)
- Frequency Measurements to 60KHz
- Flex clamp adaptor input for FLIR TA72\_TA74 and other clamp adaptors
- Input over-voltage warning
- Automatic Datalogger memory (40,000 readings over 10 sets) with selectable sample rate and Bluetooth® transmission capability
- Resistance and Continuity measurements
- Capacitance and Diode measurements
- Data HOLD
- Inrush current
- DCA zero function
- Low Z (Impedance) mode
- Minimum/Maximum memory
- Integrated VFD mode (Low-pass filter)
- Auto power off (can be disabled or preset to 1, 2, 5, or 10 minutes)
- Jaw opening 35mm (1.38")
- Easy-access battery cover mechanism
- Optional FLIR TA04 battery charging system
- Micro USB port (battery compartment) for transferring images/data logs to PC; operates similarly to a conventional thumb drive
- Safety Category Rating: CAT IV-600V, CAT III-1000V
- Equipped with batteries, test leads, carry pouch, and Quick Start booklet.



## 4. Meter Description

### 4.1 Front and Back Meter Descriptions

Fig. 4-1 Front View

1. Jaw opening trigger
2. Navigation Pad/OK button
3. MODE button
4. RANGE button
5. Data Hold (short press)/Work Light (long press)
6. Rotary function switch
7. COM (negative -) Probe Input jack
8. Positive (+) Probe Input jack
9. Image Save button (short press)
10. Return/Exit button
11. IGM™ button (short press)
12. Color TFT Display
13. Clamp jaw

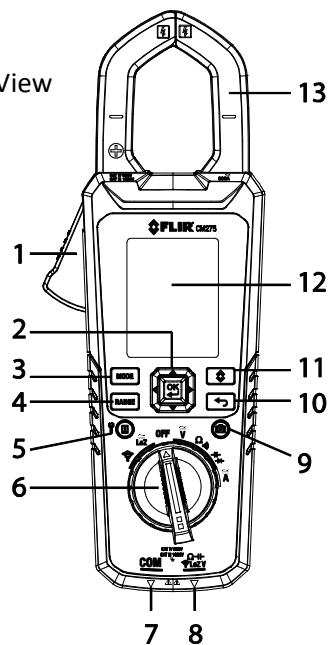





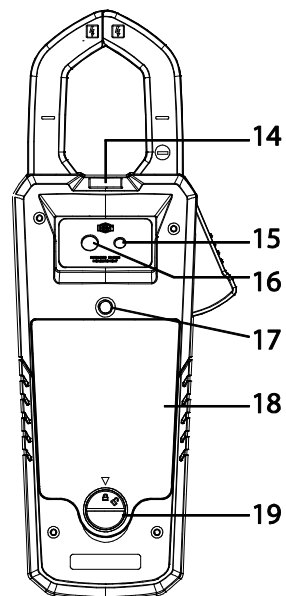

14. Work lights
15. Laser pointer lens
16. Thermal Imaging lens
17. Tripod mount
18. Battery compartment (micro USB port)
19. Battery compartment lock/unlock







Fig. 4-2 Rear View









## 4.2 Function Switch Positions

	Select this position when connecting a FLIR Flex Clamp Adaptor. See <a href="#">Section 9.9, Clamp Adaptor (FLEX) Current and Frequency Measurements</a>
	Select this position to measure in the low impedance mode. <a href="#">See Section 9.11, Voltage, Lo Z, and Frequency Measurements</a>
<b>OFF</b>	Switch the meter OFF (full power saving mode).
	Measure AC/DC Voltage through the probe inputs. See <a href="#">Section 9.11, Voltage, Lo Z, and Frequency Measurements</a>
	Measure resistance and continuity through the probe inputs. See <a href="#">Section 9.12, Resistance Measurements</a> and <a href="#">Section 9.13, Continuity Test</a>
	Measure capacitance and diode through the probe inputs. See <a href="#">Section 9.16, Capacitance Measurements</a> , <a href="#">Section 9.14, Classic Diode Test</a> , or <a href="#">Section 9.15, Smart Diode Test</a>
	Measure AC/DC current through the clamp jaws. See <a href="#">Section 9.8, Current and Frequency Measurements</a>

## 4.3 Function Buttons and Selector/Navigation Pad

	Use to select a sub-function of the primary function. <a href="#">See Section 4.3.1, MODE Button Operation</a> , for details
	From Auto range mode, short press to select Manual range mode. From Manual range mode, short press to change the range (scale). Long press to return to Auto range mode
	Short press to activate/deactivate the Thermal Imager
	Use the Navigation pad to enable/navigate menu options
	Press to return from a menu screen
	Short press to enter/exit the Hold mode. Long press to switch work lights on/off
	Short press to save a fully radiometric thermal image or a clamp meter display screen. Images are saved to the device's file system accessible in Gallery mode. The thermal imager must be fully initialized (indicated by display of IR temperature measurement) before radiometric data can be captured.

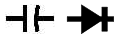
### 4.3.1 MODE Button Sequence of Operations

Rotary Switch Position	Mode Button Sequence of Operations
	ACA > Frequency
	ACV > DCV > Frequency
	ACV > DCV > Frequency
	Resistance < > Continuity
	Capacitance < > Diode
	ACA > DCA > Frequency

### 4.3.2 Navigation Pad/OK Button

There are five (5) buttons arranged in a square that make up the Navigation pad, as shown in Fig. 4-3.

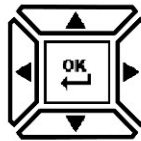

Fig. 4-3 Navigation Pad

OK button (center): Open the menu and select/change menu options

LEFT/RIGHT buttons: Navigate the menu system

UP/DOWN buttons: Navigate the menu system

### 4.4 Status Bar Display Icons









The Status Bar is located at the top right of the display.



Fig. 4-4 Status Bar Display Icons

- L to R, row 1: Datalogger, Data Hold, Auto Range, Laser, Work Light, Bluetooth®, APO, and Battery status
- L to R, row 2: Inrush current, DCA Zero, Flex Clamp icon and range, VFD, and Low Impedance mode
- Note that Diode and Continuity symbols also appear in the Status bar area of the display.

#### 4.5 Other Display Icons

	MAX (Maximum) reading
	MIN (Minimum) reading
°C, °F	Temperature units
$\epsilon$	Emissivity
	AC current or voltage
	DC current or voltage
	Continuity
$\Omega$	Resistance
	Diode
V	Voltage
A	Current (Amperes)
F	Farad (for Capacitance)
Hz	Hertz (Frequency)
k	$10^3$ (kilo)
m	$10^{-3}$ (milli)
$\mu$	$10^{-6}$ (micro)
OL	Out of Range warning
	Bar Graph
	Bar Graph overload indicator
	Meter is measuring voltage > 30 V (AC or DC)

## 5. Meter Power

### 5.1 Powering the Meter

1. Set the function switch to any position to switch on the meter.
2. If the battery indicator  shows that the battery voltage is low, if one of the Low Battery screens appears (Fig. 5-1), or if the meter does not power on, replace the three (3) 'AA' batteries. See [Section 12.2, Battery Replacement](#). If using the Model TA04 charging system, please recharge the rechargeable battery.

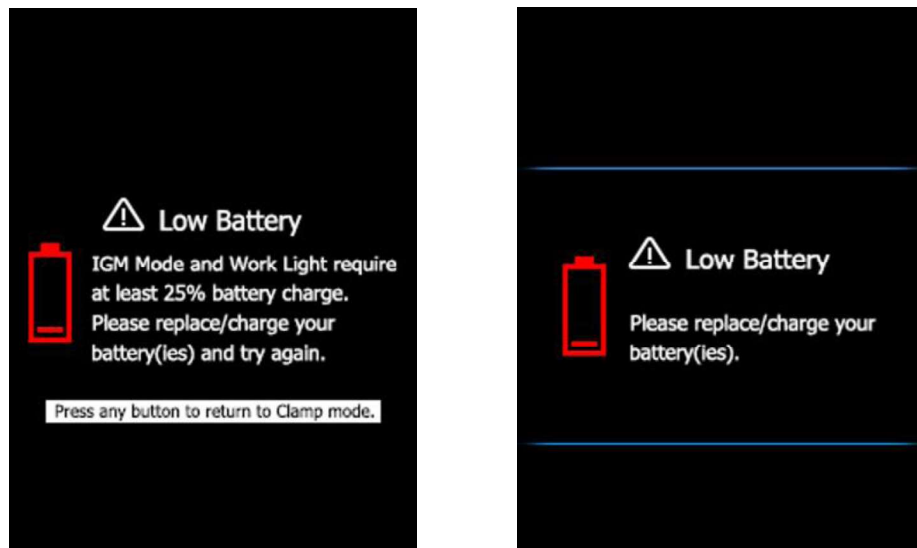

FIG. 5-1 Low Battery Alerts

### 5.2 Auto Power OFF (APO)

The meter enters sleep mode after a programmable period of inactivity, to customize this setting please see [Section 7.1.2, APO \(Auto Power OFF\)](#). The default time-out is 10 minutes. The time can be set to 1, 2, 5, or 10 minutes (select OFF to disable the APO). 20 seconds prior to entering APO mode, the meter beeps; at this point, press any button or turn the Rotary Switch to reset the APO timer.

### 5.3 Battery Type Selection

The user must enter the battery type (Lithium or Alkaline) in the General Settings menu before use. This allows the meter to display battery status as accurately as possible. Refer to [Section 7.1.5, Battery Selection](#).

## 6. Menu System

### 6.1 Using the Menu System

- Press **OK** to open the main menu, shown below:





**Fig. 6-1** Main Menu

- Use the **Navigation Pad** left/right arrows to highlight an icon. From left to right the icons are *Image Mode*, *Thermal Settings*, *Gallery (for viewing stored images and data logs)*, *Advanced Menu*, and *General Settings*.
- Press **OK** to open a menu or to set an option ON or OFF. When an option is ON a blue dot will appear next its icon. In some cases, use the navigation arrows to select an option.
- Use the Return  button to exit menu levels and to return to the normal display mode.
- The mode of the meter dictates what icons are available for use.

### 6.2 Main Menu Options

#### 6.2.1 Image Mode

This Image mode icon  is only available in the thermal imaging mode. The Image mode has two options:

 **Image + Clamp** mode (default): Display will show Clamp meter data on the thermal images while in the thermal imaging mode.

 **Image-only** mode: Display shows thermal image data only in the thermal imaging mode.

Press **OK** on the Image mode icon to open the menu and use the arrow buttons to select the desired option.

#### 6.2.2 Thermal Settings Menu

Press **OK** at the Thermal Settings icon  to access the following options: *Color Palette*, *Emissivity*, *Temperature units*, *Laser pointer ON/OFF*, and *Cross hairs ON/OFF*. Refer to [Section 8.3, Thermal Settings Menu](#) (*Color Palette*, *Emissivity*, *Temperature Units*, *Laser Pointer*, and *Crosshairs*) for detailed information.



**Fig. 6-2** Thermal Settings Menu

### 6.2.3 Gallery Mode

In Gallery  mode, view stored images and logged readings.

- Press **OK** at the Gallery  icon. The display will show rows of stored images on the lower area of the display and data logs on the upper area.
- Use the up/down arrows to step between image and reading log areas.
- Use the left/right arrows to scroll through data logs or images.
- Press **OK** to open a reading log or an image.
- Press **OK** again on an image to bring up icons that will permit you to delete the image, transmit the image via Bluetooth®, and to resize the image to full screen.
- Press **OK** again on a data log set to bring up icons that permit you to delete the log or to transmit the log via Bluetooth®.
- Note that there is a micro USB port located in the battery compartment that allows you to transfer data logs and images directly to your PC. When connected to a PC, use the meter's internal memory as you would a standard external storage drive.
- For More detailed information, [see Section 7.1.9, Delete all Datalogger Readings](#), [Section 7.1.10, Delete all Stored Images](#), [Section 8.5, Image Capture](#), and [Section 9.7, Datalogger](#)

### 6.2.4 Advanced Functions Menu

Press **OK** at the Advanced Functions Menu icon  to access the functions listed below. Highlight a function using the arrow buttons and then press **OK** to activate it. Refer to the dedicated section for each as listed below for detailed information:

- VFD (low pass filter), see [Section 9.4, VFD mode](#)
- MAX-MIN Readings, [Section 9.5, MAX-MIN mode](#)
- Inrush Current, [Section 9.10, Inrush Current mode](#)
- DCA Zero, [Section 9.6, DCA mode](#)
- Datalogger, [Section 9.7, Datalogger](#)

### 6.2.5 General Settings Menu

1. Press **OK** to open the main menu.
2. Press **OK** at the General Settings icon  to access the options.
3. See next section for detailed information on the General Settings mode

## 7. General Settings

### 7.1 General Settings Navigation

Under General Settings, the user can customize a variety of features.



1. Press **OK** to open the Main Menu
2. Scroll to the  icon and press **OK** to open the Settings menu (see Fig. 7-1)
3. Press **OK** on a menu item and customize the item per the table below
4. Use the  button to exit screens and to return to the normal mode
5. A blue dot next to an option indicates that an option is ON





Fig. 7-1 General Settings Menu

#### 7.1.1 Diode SMART/CLASSIC

 Press **OK** to toggle SMART/CLASSIC diode modes

#### 7.1.2 APO (Auto Power OFF)

 Press **OK** to open the sub-menu. Scroll to OFF, 1, 2, 5, or 10 minutes for the Auto Power OFF timer and press **OK** to select. Press  to exit the menu

#### 7.1.3 Datalogger Sample Rate

 Press **OK** to access the selector. Use the arrow buttons to select the desired datalogger sampling rate from 1 ~ 99 seconds. Press **OK** to confirm

#### 7.1.4 Real-time Clock

 Press **OK** to open the date/time setting screen. Use the arrow buttons to scroll through the date and time fields and to select the current date and time. Press **OK** to confirm



### 7.1.5 Battery Selection

 Press **OK** to toggle **LITHIUM AA** and **ALKALINE AA** battery types. Select the battery type in use.

### 7.1.6 Bluetooth® ON/OFF

 Press **OK** to toggle Bluetooth® ON/OFF (default is ON). Refer to [Section 10, Bluetooth®](#)

### 7.1.7 Button-press tone ON/OFF

 Press **OK** to toggle the button-press tone ON/OFF

### 7.1.8 Language selection

Press **OK** to open the menu. Scroll to the desired language and press **OK**. Press  to exit

### 7.1.9 Delete all Datalogger readings

 Press **OK** to delete all datalogger records. The meter will ask for confirmation

### 7.1.10 Delete all Stored Images

 Press **OK** to delete all saved images. The meter will ask for confirmation

### 7.1.11 View HELP Screen

 Press **OK** to view FLIR support contact information

### 7.1.12 Viewing meter component information

 Press **OK** to view meter component firmware version information and Laser data:

 Meter firmware version

 Lepton® camera interface firmware version

 Bluetooth® firmware version

 Laser data

## 8. Thermal Imaging

### 8.1 Thermal Imager Basics

In the Thermal Imaging mode, the user can measure a targeted surface's temperature by detecting the energy emitted by the surface under test. Color variations reflect temperature variations. See [Section 11.3, Infrared Energy and Thermal Imaging Overview](#) for in-depth information. The laser pointer and display cross hairs assist in targeting.

Press the IGM button to open the Thermal Imager. In [Fig 8-1](#) the meter is set to color palette IRON. Select other palettes in the Thermal Settings Menu (refer to [Section 8.3, Thermal Settings Menu](#)).

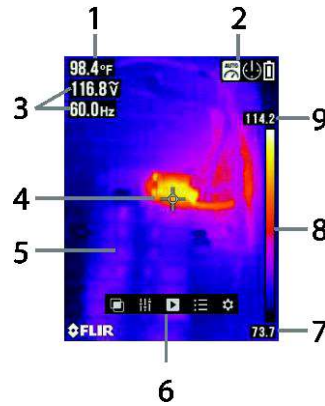

**Fig. 8-1** Thermal Image Example

1. **IR Temperature measurement** represents the temperature of the spot sensed. Note that while the imager initializes, dashes will display.
2. **Status Icon Bar**
3. **Clamp Meter Measurement displays**
4. **Cross hairs** for targeting spots
5. **Thermal image**
6. **Main Menu**
7. **Lowest reading** measured in the current frame
8. **Thermal scale** shows the range of colors for the thermal image. The lighter the color, the warmer the temperature; the darker the color, the cooler the temperature.
9. **Highest reading** measured in the current frame.

Note: Use the Thermal Settings Menu to change the emissivity; refer to [Section 8.3, Thermal Settings Menu](#). See also [Section 11.1, Emissivity Factors for Common Materials](#).

## 8.2 Thermal Imager Operation

To customize the Thermal Imager, refer to [Section 8.3, Thermal Settings Menu](#). For basic operation, follow these steps:

1. Set the function switch to any position.
2. Press the **IGM** button to switch the Thermal Imager ON. Point the thermal imaging lens (back of meter) toward an area to test.
3. The display will show the temperature in the upper left hand corner for the targeted area.
4. In the Thermal Imaging mode, use the laser pointer and display cross hairs for targeting. These can be switched ON or OFF in the Thermal Settings Menu.
5. In the Thermal imaging mode, the meter continues to operate normally as a Clamp Meter. Note that in the Thermal Imaging mode, view clamp measurements and function on the left side of the display. If desired, the meter can be set to image-only mode in the Image Mode menu, see [Section 8.4, Image Mode Menu](#).
6. The Distance to Spot ratio for the imager is 30:1 meaning that the measurement spot is 30 times smaller than the distance from meter to spot (at a distance of 30", the meter 'sees' a target spot of 1"). **See Fig. 8-2.**
7. The thermal imager's FOV (Field of View) is 44 degrees (vertical) and 57 degrees (horizontal) see [Fig. 8-3 \(a\) and \(b\)](#).

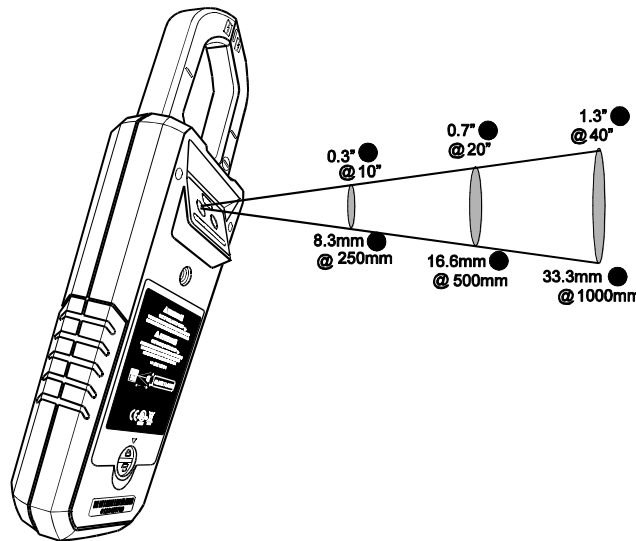

**Fig. 8-2** Distance-to-Spot ratio 30:1

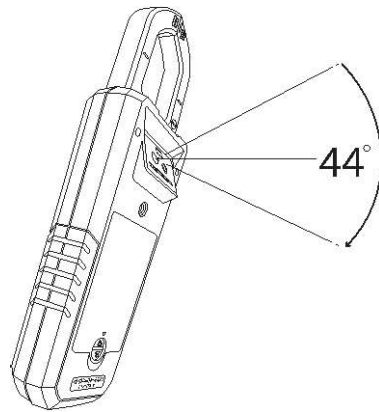

Fig. 8-3 (a) Field of View – vertical

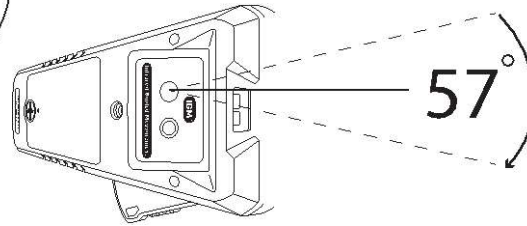

Fig. 8-3 (b) Field of View - horizontal

### 8.3 Thermal Settings Menu (Color Palette, Emissivity, Temperature Units, Laser Pointer, Crosshairs)







1. Press **OK** to open the main menu
2. Scroll to the Thermal Settings  icon and press **OK**
3. Refer to the Thermal Settings screenshot and details below





Fig. 8.4 Thermal Settings Menu

Icon	Description	Use
	Color Palette	Press <b>OK</b> to step through the display color palettes (Iron, Rainbow, or Gray).
	Emissivity	Press <b>OK</b> and then use up/down arrows to scroll to a preset (0.95, 0.85, 0.75, or 0.65) or to the fine tuning <b>E</b> icon. To fine tune, press <b>OK</b> at the fine tuning icon and use the arrow buttons to set the value, press <b>OK</b> to confirm. The available range is 0.10 to 0.99 in 0.01 steps.
	Temp. units	Press <b>OK</b> to toggle the temperature units (°C/°F)
	Laser pointer	Press <b>OK</b> to toggle the laser pointer ON (blue circle) or OFF
	Cross hairs	Press <b>OK</b> to switch the cross hairs ON or OFF

## 8.4 Image Mode Menu

The Image Mode menu  allows you to select:

**Image + Clamp** mode  where you can view Clamp meter data superimposed on the thermal images or:



**Image-only** mode  where Clamp meter measurements are removed from the thermal images

## 8.5 Image Capture



Short press the Display Save button  to store a displayed, fully radiometric, thermal image (or a clamp meter screen) to the meter's internal memory. Up to 100 images can be stored.

Saved thermal images are fully radiometric (each pixel includes temperature measurement data). Note that the imager must be fully initialized (indicated by display of IR temperature measurement instead of dashes) before radiometric data can be captured. To view radiometric data within captured thermal images, copy the images to a PC and view using *FLIR Tools*.

To view stored images:

1. Press **OK** to open the Main Menu
2. Press **OK** at the Gallery  icon
3. Use the left/right arrow buttons to scroll through the images (note that the datalogging records are located here also, on the upper display area)
4. Press **OK** to open a selected image
5. Press **OK** to open a menu permitting recycling of image, full-screen sizing, and transmission of image via Bluetooth®
6. Use the RETURN  button to exit screens and to return to the normal operating mode

## 8.6 Image Freeze (Data Hold)

In Data Hold mode, the displayed reading or thermal image is frozen. To enter/exit Data Hold mode, press the  button. In Hold mode, the  indicator appears.

## 9. Clamp Meter Operation





**Caution:** Before operating the device, you must read, understand, and follow all instructions, dangers, warnings, cautions, and notes.

**Caution:** When the meter is not in use, the function switch should be set to the OFF position.

**Caution:** When connecting the probe leads to the device under test, connect the COM (negative) lead before connecting the positive lead. When removing the probe leads, remove the positive lead before removing the COM (negative) lead.

### 9.1 Auto/Manual Range Mode



In Auto range mode, the meter automatically selects the most appropriate measurement scale. In Manual range mode, the desired range (scale) can be adjusted by the user. Auto range mode is the default mode of operation. When a new function is selected with the function switch, the starting mode is Auto range and the  indicator is displayed.

1. To enter Manual range mode, short press the  button. To change the range, press the  button repeatedly until the desired range is displayed.
2. To return to the Auto range mode, long press the  button until the Auto Range  indicator is again displayed.

### 9.2 Out-of-range Warning (OL)



If the input is over/under the full-scale range in Manual range mode, or if the signal has exceeded the maximum/minimum input in Auto range mode, 'OL' is displayed.

### 9.3 Data Hold

In Data Hold mode, the displayed reading or thermal image is frozen. To enter/exit Data Hold mode, press the  button. In Hold mode, the  indicator is displayed.



### 9.4 VFD Mode (Low Pass Filter)

The VFD (variable-frequency drive) utility eliminates high-frequency noise from AC measurements with a low-pass filter. VFD mode is available when measuring AC voltage or AC current.

1. Press **OK** to access the main menu
2. Press **OK** at the Advanced Menu icon 
3. Press **OK** at the VFD icon 
4. The blue dot next to the icon and the VFD display icon will appear
5. De-select the VFD mode by pressing **OK** again. The blue dot and VFD display icon will switch OFF when de-selected

## 9.5 MAX-MIN Mode



The meter captures and displays the maximum and minimum readings, updating only when a higher/lower value is registered.

1. Press **OK** to access the main menu
2. Press **OK** at the Advanced Menu icon
3. Press **OK** at the MAX-MIN icon  to show Maximum  and Minimum  readings.

## 9.6 DCA Zero Mode

The DC zero feature removes offset values and improves DC Current accuracy. Before executing the steps below, set the clamp meter to the DC Current measurement mode (see [Section 9.8, Current and Frequency Measurements](#)).



Note that this feature cannot correct for errors greater than 20A.

1. Press **OK** to access the main menu
2. Press **OK** at the Advanced Menu  icon
3. Press **OK** at the icon , the display will zero and the DCA icon  will appear



## 9.7 Datalogger

Log up to 40,000 total readings over ten memory 'sets'. Each time the datalogger is started a new memory set is opened and the previous one is archived.

To start logging:

1. Press **OK** to access the main menu
2. Press **OK** at the Advanced Menu  icon
3. Press **OK** at the icon  to begin storing readings at the sample rate selected in the General Settings menu, see [Section 7.1.3, Datalogger Sample Rate](#). The datalogger display icon will appear while the logger is running

To stop logging:

1. Press **OK** to access the main menu
2. Press **OK** at the Advanced Menu  icon
3. Press **OK** at the icon  to stop. The datalogger display icon will switch off

To view logs:

1. Press **OK** to access the Main menu
2. Press **OK** at the Gallery  icon
3. Use the up arrow to move the cursor up to the log area of the display (the lower area is for saved images). Scroll left/right to a data 'set' and press **OK** to open it. The list of recorded measurements for the set will appear.

To delete datalog sets:

1. With a datalog set open, press **OK**. Two icons will appear on the bottom of the display, one for transmitting data and one for deleting.
2. Scroll to the Trash icon and press **OK** to delete all of the readings in the selected set.
3. To delete ALL datalog sets at once, see [Section 7.1.9, Delete All Datalog Readings](#).

To transmit a datalog set via Bluetooth®:

1. Transmit data logs to a remote device running the FLIR Tools software suite. Refer to [Section 10, Bluetooth® Communication](#) for more information.
2. With a datalog 'set' open, press **OK**. Two icons will appear on the bottom of the display (for transmitting or deleting).
3. Scroll to the transmission icon and press **OK** to begin transmitting all of the readings in the selected set.
4. Note that a micro USB port is located in the battery compartment. When connected to a PC the CM275 operates in the same manner as an external storage medium where you can drag and drop data logs and images from the meter's internal memory to a PC.



## 9.8 Current and Frequency Measurements

**⚠ WARNING** Do not measure the current on a circuit when the voltage increases to more than 1000V. This can cause damage to the instrument and can cause injury to persons.

When measuring current, the jaws should enclose one conductor only—refer to Fig. 9-1.

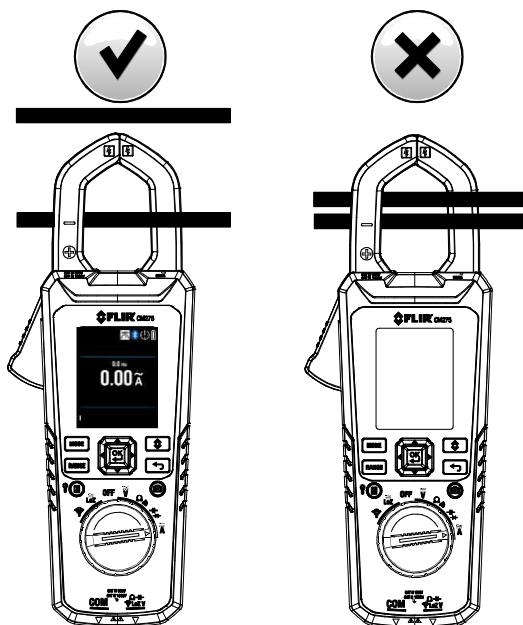

**Fig. 9.1** Correct (left image) and incorrect (right image)

1. Disconnect the probe leads from the meter.
2. Set the function switch to the **A** position.
3. Select AC or DC using the **MODE** button. If measuring DC Current be sure to ZERO the display per [Section 9.6, DCA Zero Mode](#).
4. To manually select the measurement range (scale), press the **RANGE** button repeatedly. Refer to [Section 9.1, Auto/Manual range mode](#).
5. Press the trigger to open the clamp jaws. Fully enclose one conductor—refer to Fig. 9.2. For optimum results, center the conductor in the jaws.
6. Read the current value on the display.
7. To see the Frequency measurement for an AC Current measurement use the **MODE** button to step to the Hz display.
8. For VFD mode operation refer to [Section 9.4, VFD Mode](#).
9. For MAX-MIN operation, refer to [Section 9.5, MAX-MIN Mode](#).

## 9.9 Clamp Adaptor (FLEX) Current and Frequency Measurements

**⚠ WARNING** Do not measure the current on a circuit when the voltage increases to more than 1000V. This can cause damage to the instrument and can cause injury to persons.

FLIR Flex Clamp Adaptors (Models TA72 and TA74, for example) and other clamp adaptors can connect to the CM275 to display current measurements.

Note: When measuring current, enclose only one conductor with the jaws.

1. Turn the function dial to the  position.
2. Connect a Clamp adaptor as shown in **Fig. 9-2**.
3. Set the Range of the Flex Clamp Adaptor to match the range of the CM275.
4. Use the **RANGE** button to select the range of the CM275 (1, 10, 100 mV/A). The selected range appears on the CM275 display.
5. Operate the Flex Clamp per instructions provided with the Flex Clamp meter.
6. Read the current measured by the Flex Clamp on the CM275 LCD. Short press the **MODE** button to view the frequency (Hz).

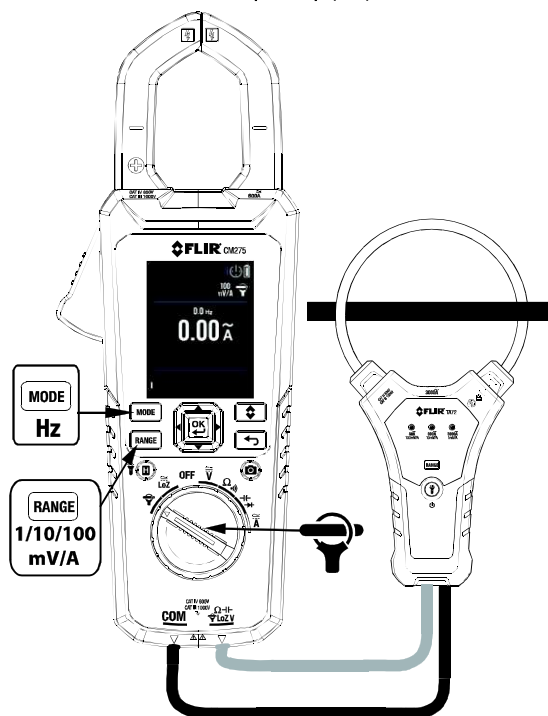

**Fig. 9-2** FLEX Clamp Application

## 9.10 Inrush Current Measurements

In Inrush Current mode, the meter displays the AC RMS current reading in the first 100ms period after the trigger point (current detection threshold) is reached, see **Fig. 9-3** below.

### For the FLEX Current function:

Current detection threshold is 0.5A for 30.00A

Current detection threshold is 5A for 300.0A



Current detection threshold is 50A for 3000A

### For CLAMP Current function:

Current detection threshold is 0.5A for 60.00A

Current detection threshold is 5A for 600.0A

Inrush current mode is available when measuring AC current.



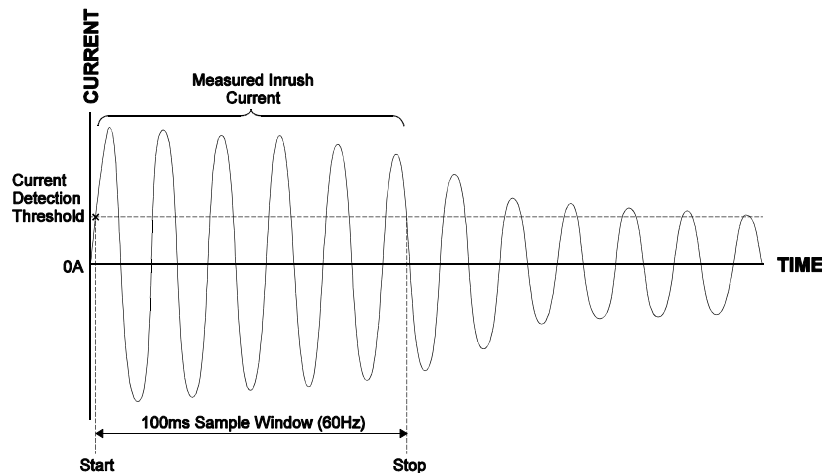

1. Press **OK** to access the main menu
2. Press **OK** at the Advanced Menu  icon
3. Press **OK** at the Inrush Current icon , the Inrush display icon will appear
4. Connect the meter to the unpowered circuit under test
5. Set the meter to the  **A** position
6. Turn on the power to the circuit under test
7. When it reaches the threshold, the meter will display the RMS reading for the 100ms integration time.

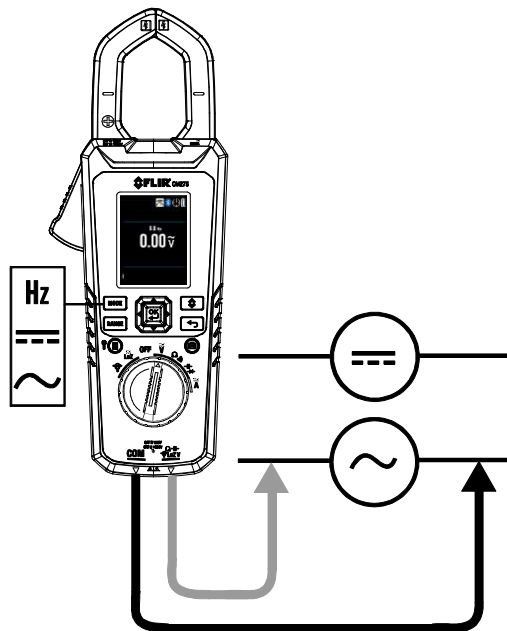

**Fig. 9-3** Inrush Current

## 9.11 Voltage, Lo Z, and Frequency Measurements

**Warning:** If the measured voltage is  $> 30$  V DC or AC RMS, the  indicator is displayed.

1. Set the function switch to one of the following positions:
  -  Voltage AC/DC measurements.
  -  Voltage AC/DC measurements with a low impedance circuit, eliminating ghost voltages. The impedance is approx.  $2.5k\Omega$ . The **LoZ** indicator appears in this mode.
2. Insert the black probe lead into the negative COM terminal and the red probe lead into the positive terminal. Refer to Fig. 9-4 below.
3. Use the **MODE** button to select AC or DC measurement.
  - The  indicator appears for AC measurements.
  - The  indicator appears for DC measurements.
4. Connect the probe leads in parallel to the part under test.
5. Read the voltage value on the display.
6. To view the frequency (Hz) of the measured voltage, short press the **MODE** button until the Hz reading appears.
7. For VFD mode operation refer to [Section 9.4, VFD Mode](#).
8. For MAX-MIN operation, refer to [Section 9.5, MAX-MIN Mode](#).

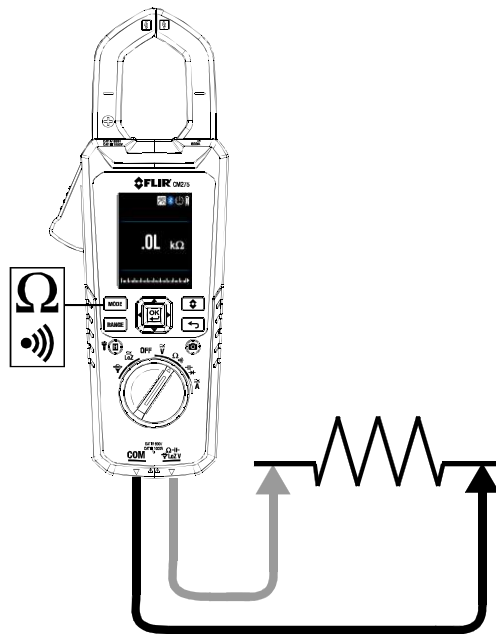

**Fig. 9-4** Voltage and Frequency Measurements

## 9.12 Resistance Measurements

**Warning:** Do not perform diode, resistance or continuity tests before removing power from capacitors and other devices under test during a measurement. Injury to persons can occur.

1. Refer to **Fig. 9-5**. Set the function switch to the  $\Omega$   $\bullet$ ) position.
2. Use **MODE** to step to the **k $\Omega$**  display if necessary.
3. Insert the black probe lead into the negative COM terminal and the red probe lead into the positive  $\Omega$  terminal.
4. Touch the tips of the probe across the circuit or component under test.
5. Read the resistance value on the display.
6. For MAX-MIN operation, refer to [Section 9.5, MAX-MIN Mode](#).



**Fig. 9-5** Resistance and Continuity Measurements

## 9.13 Continuity Test

**Warning:** Do not perform diode, resistance or continuity tests before removing the power from capacitors and other devices under test during a measurement. Injury to persons can occur.

1. Refer to **Fig. 9-5**. Set the function switch to the  $\Omega$   $\bullet$ ) position.
2. Use the **MODE** button to select continuity. The  $\bullet$ ) icon will appear.

3. Insert the black probe lead into the negative COM terminal and the red probe lead into the positive  $\ominus$  terminal.
4. Touch the tips of the probe across the circuit or component under test.
5. If the resistance is  $< 30\Omega$  the meter beeps. If the resistance is  $> 150\Omega$  the meter will not beep.  $> 30\Omega$  but  $< 150\Omega$  the beeping will stop at an unspecified point.

## 9.14 Classic Diode Test

**Warning:** Do not perform diode tests before removing the power to the diode or other devices under test during a measurement. Injury to persons can occur.

1. If not already selected, choose CLASSIC Diode test mode in the General Settings menu ([Section 7.1.1, Diode Smart/Classic](#)).
2. Set the function switch to the diode  $\leftarrow| \rightarrow$  position. Use the **MODE** button to select the diode function. The diode indicator  $\rightarrow|$  will appear.
3. Insert the black probe lead into the negative COM terminal and the red probe lead into the positive terminal.
4. Touch the tips of the probe across the diode or semiconductor junction in one polarity (direction) and then in the opposite polarity as shown in **Fig. 9-6**.
5. If the reading is between 0.400 and 0.800V in one direction and OL (overload) in the opposite direction, the component is good. If the measurement is 0V in both directions (shorted) or OL in both directions (open), the component is bad.

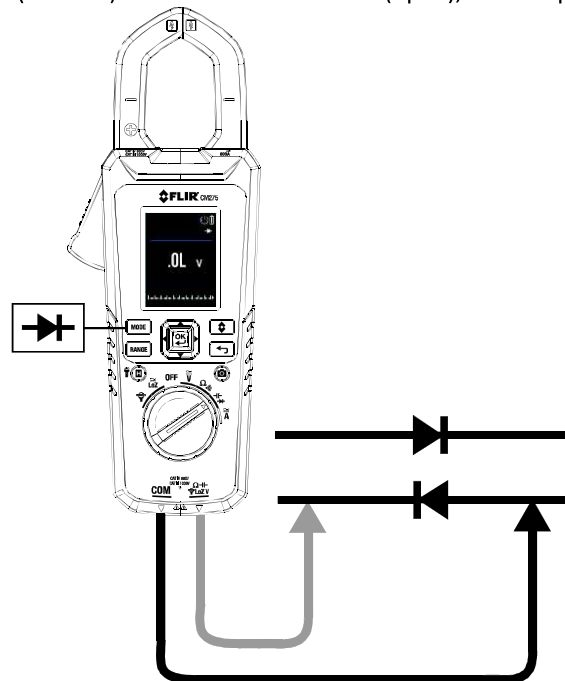

**Fig. 9-6** Classic Diode Test

## 9.15 Smart Diode Test

**Warning:** Do not perform diode tests before removing the power from capacitors and other devices under test during a measurement. Injury to persons can occur.

1. If not already selected, choose SMART Diode test mode in the General Settings menu ([Section 7.1.1, Diode Smart/Classic](#)).
2. Set the function switch to the diode  $\leftarrow| \rightarrow$  position. Use the **MODE** button to select the diode test function. The diode indicator  $\rightarrow|$  will appear.
3. Insert the black probe lead into the negative COM terminal and the red probe lead into the positive  $\Omega$  terminal. Refer to **Fig. 9-6** above.
4. Touch the tips of the probe across the diode or semiconductor junction under test.
5. If the reading is between  $\pm 0.400 \sim 0.800V$ , the component is good; BAD or O.L displays indicate a defective component.

**NOTES:** In SMART Diode mode the meter checks diodes using an alternating test signal sent through the diode in both directions. This allows the user to check the diode without having to reverse polarity manually. The meter display will show  $\pm 0.400 \sim 0.800V$  for a good diode, 'BAD' for a shorted diode, and 'O.L' for an opened diode. See **Fig. 9-7** below:

**Fig. 9-7** SMART Diode Test

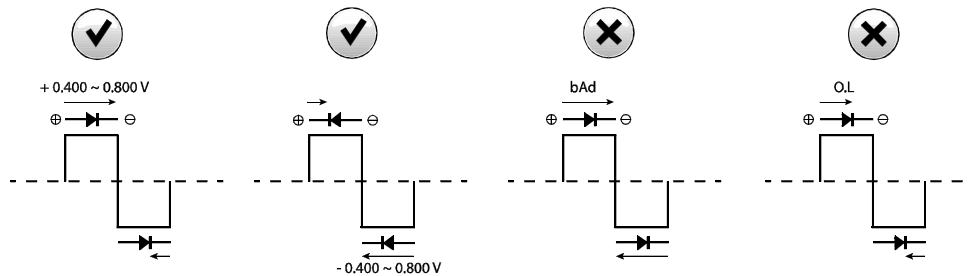

## 9.16 Capacitance Measurements

**Warning:** Do not perform capacitance tests before removing power to the capacitor or other devices under test during a measurement. Injury to persons can occur.

1. Set the function switch to the  $\leftarrow \text{||} \rightarrow$  position.
2. Use the **MODE** button to select the capacitance measurement. The F (Farad) unit of measure will appear.
3. Insert the black probe lead into the negative COM terminal and the red probe lead into the positive terminal. Refer to **Fig. 9-8** below.
4. Touch the tips of the probe across the part under test.
5. Read the capacitance value on the display.
6. For MAX-MIN operation, refer to [Section 9.5, MAX-MIN Mode](#).

**Note:** For very large capacitance values, it may take several minutes for the measurement to settle and the final reading to stabilize.

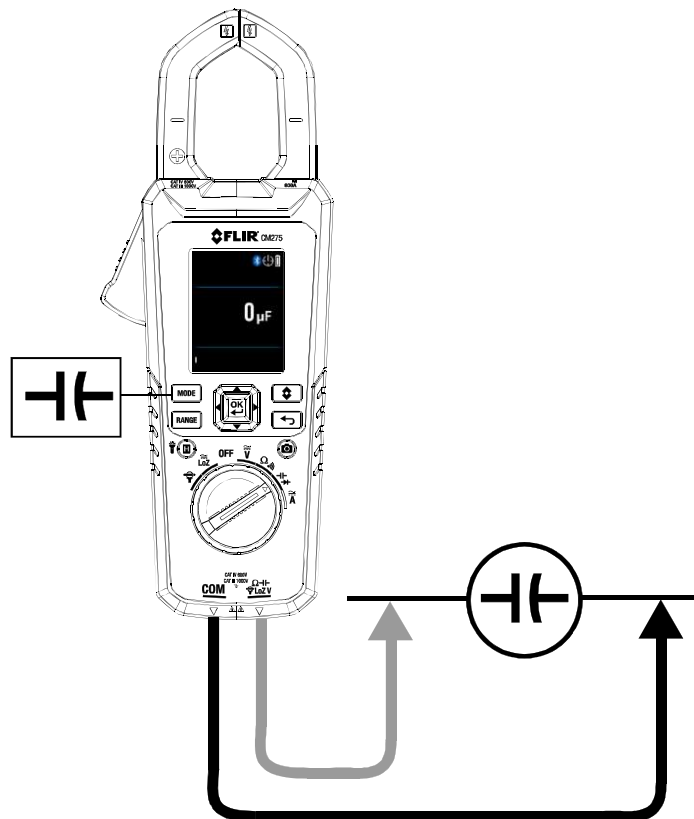

Fig. 9-8 Capacitance Measurements



## 10. Bluetooth® Communication

---



When connected to a remote device running the **FLIR Tools** software suite, the CM275 (using the **METERLiNK**® protocol) can:

- Send readings for live display on the remote device
- Send saved data log files to the remote device
- Send saved screen images (thermal and DMM) to the remote device

When connected to a remote FLIR camera that supports Bluetooth® BLE (Bluetooth® Low Energy), the CM275 can:

- Send meter readings for live display on the camera screen

Download the **FLIR Tools** software suite at the link below:

1. Any Bluetooth® BLE device running FLIR Tools can find and connect to the CM275.
2. When successful communication between the meter and a remote device or FLIR camera is established, the Bluetooth® icon  appears on the meter display.
3. Open the main menu (by pressing **OK**) and use the Gallery mode  to locate the stored images and data log sets. You can transmit Images and data log sets directly from the Gallery mode. For further information, refer to [Section 6.2.3, Gallery mode](#) and [Section 9.7, Datalogger](#).
4. Refer to the **FLIR Tools** help utility (in the software suite) for detailed information and tutorials regarding the **FLIR Tools** application.

Note: The Bluetooth® utility defaults to ON but can be disabled if desired in the General Settings menu (see [Section 7, General Settings](#)).

## 11. Appendices

---

### 11.1 Emissivity Factors for Common Materials

Material	Emissivity	Material	Emissivity
Asphalt	0.90 to 0.98	Cloth (black)	0.98
Concrete	0.94	Skin (human)	0.98
Cement	0.96	Leather	0.75 to 0.80
Sand	0.90	Charcoal (powder)	0.96
Soil	0.92 to 0.96	Lacquer	0.80 to 0.95
Water	0.92 to 0.96	Lacquer (matt)	0.97
Ice	0.96 to 0.98	Rubber (black)	0.94
Snow	0.83	Plastic	0.85 to 0.95
Glass	0.90 to 0.95	Timber	0.90
Ceramic	0.90 to 0.94	Paper	0.70 to 0.94
Marble	0.94	Chromium Oxides	0.81
Plaster	0.80 to 0.90	Copper Oxides	0.78
Mortar	0.89 to 0.91	Iron Oxides	0.78 to 0.82
Brick	0.93 to 0.96	Textiles	0.90

### 11.2 Non-Uniformity Correction

A non-uniformity correction (or NUC) is an image correction carried out by the camera software to compensate for different sensitivities of detector elements and other optical and geometrical disturbances<sup>1</sup>.

The NUC is an automatic function that takes place periodically (approximately every 2-3 minutes) or whenever the inner core of the camera detects a  $\pm 2^{\circ}\text{C}$  temperature change.

1. Definition from the imminent international adoption of DIN 54190-3 (Non-destructive testing – Thermographic testing – Part 3: Terms and definitions).

### 11.3 Infrared Energy and Thermal Imaging Overview

A thermal imager generates an image based on temperature differences. In a thermal image, the hottest item in the scene appears as white and the coldest item as black. All other items are represented as a gray scale value between white and black. The CM275 also offers color images to simulate hot (lighter colors) and cold (darker colors) temperatures.

It may take some time to get used to the thermal imagery. Having a basic understanding of the differences between thermal and daylight cameras can help with getting the best performance from the CM275.

One difference between thermal and daylight cameras has to do with where the energy comes from to create an image. When viewing an image with an ordinary camera, there has to be some source of visible light (something hot, such as the sun or other lighting) that reflects off the objects in the scene to the camera. The same is true with human eyesight; the vast majority of what people see is based on reflected light energy. On the other hand, the thermal imager detects energy that is directly radiated from objects in the scene.

This is why hot objects such as parts on engines and exhaust pipes appear white, while the sky, puddles of water and other cold objects appear dark (or cool). Scenes with familiar objects will be easy to interpret with some experience.

Infrared energy is part of a complete range of radiation called the electromagnetic spectrum. The electromagnetic spectrum includes gamma rays, X-rays, ultraviolet, visible, infrared, microwaves (RADAR), and radio waves. The only difference is their wavelength or frequency. All of these forms of radiation travel at the speed of light. Infrared radiation lies between the visible and RADAR portions of the electromagnetic spectrum.

The primary source of infrared radiation is heat or thermal radiation. Any object that has a temperature radiates in the infrared portion of the electromagnetic spectrum. Even objects that are very cold, such as an ice cube, emit infrared. When an object is not quite hot enough to radiate visible light, it will emit most of its energy in the infrared. For example, hot charcoal may not give off light, but it does emit infrared radiation, which we feel as heat. The warmer the object, the more infrared radiation it emits.

Infrared imaging devices produce an image of invisible infrared or “heat” radiation that is unseen by the human eye. There are no colors or “shades” of gray in infrared, only varying intensities of radiated energy. The infrared imager converts this energy into an image that we can interpret.

The **FLIR Infrared Training center** offers training (including online training) and certification in all aspects of thermography:

## 12. Maintenance

---

### 12.1 Cleaning and Storage

Wipe the housing with a damp cloth as needed. Use a high-quality lens wipe to remove dirt or smudges from the meter lenses and display window. Please do not use abrasives or solvents to clean the meter housing, lenses, or display window.

If the meter is not to be used for an extended period, remove the batteries and store them separately.

### 12.2 Battery Replacement

The Battery symbol flashes with no 'bars' when the batteries have reached a critical level. The meter displays readings within specifications while the low battery indicator is on. The meter powers off before it displays an out of tolerance reading.

**WARNING:** To avoid electrical shock, disconnect the meter from any connected circuits, remove the test leads from the meter terminals, and set the function switch to the OFF position before attempting to replace the batteries.

1. Unscrew and remove the battery compartment cover.
2. Replace the three (3) standard AA batteries, observing correct polarity.
3. If using the Model TA04 rechargeable lithium polymer battery system, please recharge the rechargeable battery.
4. Secure the battery compartment cover.

### 12.3 Disposal of Electronic Waste

As with most electronic products, this equipment must be disposed of in an environmentally friendly way, and in accordance with existing regulations for electronic waste. Please contact your FLIR Systems representative for more details.

## 13. Specifications

### 13.1 General specifications

Display counts: 0~6000  
 Measuring rate: 3 times per second  
 Over-range indication: OL or -OL  
 Auto power off: Programmable: OFF, 1, 2, 5, or 10 (default) minutes  
 Low battery indicators:  and low battery informaton screens appear  
 Power requirement: 3 x 1.5 V 'AA' alkaline/lithium batteries or TA04 rechargeable battery  
 Approximate battery life for thermal imager:

- 2.5 hours: Alkaline 'AA' Battery x 3
- 12 hours: Energizer L91 Lithium (Li/FeS<sub>2</sub>) 'AA' Battery x 3
- 12 hours: Optional Rechargeable Battery: Li-Polymer; FLIR PN: TA04-KIT

Calibration: 1-year calibration cycle

Operating temperature:

32 to 86°F (0 to 30°C) (≤ 80% RH)

86 to 104°F (30 to 40°C) (≤ 75% RH)

104 to 122°F (40 to 50°C) (≤ 45%RH)

Storage temperature: 4 to 140°F (-20 to 60°C)

Relative Humidity: 0~80% RH (batteries not installed)

Temperature coefficient: 0.2 x (specified accuracy)/°C, <64.4°F (18°C), >82.4°F (28°C)

Operating altitude: 6562' (2000m)

Jaw opening: 1.38in (35mm)

Pollution degree: 2

IP Rating IP40

Dimensions: (D x W x L): 1.91 x 3.82 x 10.04 in (48.5 x 97 x 255 mm)

Weight: 16.2 oz (460g) without batteries

Agency Approvals: UL, CE, RCM

Over-voltage category: EN 61010-1 CAT IV-600 V, CAT III-1000 V, EN 61010-2-032

CAT	Application field
III	Distribution circuits, machinery, main switching devices close to switchgears, industrial installations and high current close to distribution circuits
IV	Installation sources, utility transformers, all outside conductors, counters, protective devices on primary sides and electricity meters

### 13.2 Thermal Imaging Specifications

Detector type	FLIR Lepton®; Micro-bolometer Focal Plane Array (FPA)
Thermal Sensitivity	150mK
IR Imaging resolution	160 x 120 pixels
IR Imaging field of view	44° x 57° (vertical x horizontal)
IR Imaging spectral response	8 to 14µm
IR Image Capture Frequency	9Hz
IR Image Color Palettes	Programmable: Iron, Rainbow, and Gray scale
Shutter	Integrated, automatic shutter
Stored thermal image radiometry	Fully radiometric
Laser Pointer	Class I (red)
IR Temperature Measurement range	+14°F ~ +302°F (-10°C ~ +150°C)
Over- and under- range indication	OL
Temperature reading stabilization	Dashes display while temperature reading stabilizes
IR Temperature Resolution	0.1°F (0.1°C)
IR Temperature Accuracy	±5.4°F (3°C) or ± 3% of reading; whichever is greater
Distance to Spot (D:S) ratio	30:1
Temperature Scanning	Continuous
Emissivity	4 presets plus a custom setting (0.10 to 0.99)
Targeting	Displayed Cross hairs pinpoint center of measurement spot

### 13.3 Electrical Specifications

Accuracy is  $\pm$  (% reading + number of digits (dgt)) at 73.4 °F  $\pm$ 9 °F (23°C  $\pm$ 5 °C), <80% RH.

**Table 13.1** Voltage (TRMS)

Function	Range	Accuracy (of reading)
DCV	60.00V	$\pm$ (1.0% + 5 dgt)
	600.0V	
	1000 V	
ACV	60.00 V	$\pm$ (1.0% + 5 dgt) 45~400 Hz
	600.0 V	
	1000 V	
ACV VFD	60.00 V	$\pm$ (1% + 5 dgt) 45~65 Hz $\pm$ (5% + 5 dgt) 65~400 Hz
	600.0 V	
	1000 V	
Lo Z (Low Impedance)	Range, resolution, and accuracy specifications for Low Impedance (Lo Z) measurements are the same as DCV, ACV, and VFD specifications shown above	

**Notes:**

LCD Displays '0' counts when the AC reading is <10 counts

Overload protection: 1000V (rms)

Input impedance: 10 M $\Omega$  //, <100 pF

Lo Z input impedance: 2.5k $\Omega$

AC conversion type: AC coupled, true RMS responding, calibrated to the RMS value of a sine wave input. Accuracies are given for sine waves at full scale and non-sine waves below half scale.

If the meter measures a 4000-count signal and the Crest Factor of the signal is more than 3.0, the reading may not meet specified tolerances. For non-sine waves (50/60 Hz), add the following Crest Factor corrections:

For non-sine waves (50/60 Hz), add the following crest factor corrections:

For a crest factor of 1.0–2.0, add 3.0% to the accuracy.

For a crest factor of 2.0–2.5, add 5.0% to the accuracy.

For a crest factor of 2.5–3.0, add 7.0% to the accuracy.

**Table 13.2** Current (TRMS)

Function	Range	Accuracy
DCA	60.00 A	±(2% + 5 dgt)
	600.0 A	
ACA	60.00 A	± (2% + 5dgt) 45 ~ 400Hz
	600.0 A	
ACA VFD	60.00 A	± (2% + 5 dgt) 45~65Hz ± (6% + 5 dgt) 65~400Hz
	600.0 A	

**Notes:**

Display reads '0' when AC measurement < 10 counts

Overload protection: 600A (rms)

Position Error: ±1% of reading.

AC Conversion Type and additional accuracy is same as AC Voltage.

DCA affected by the temperature and residual magnetism; use DCA Zero function to compensate.

If the meter measures a 4000-count signal and the Crest Factor of the signal is more than 3.0, the reading may not meet specified tolerances. For non-sine waves (50/60 Hz), add the following Crest Factor corrections:

For non-sine waves (50/60 Hz), add the following crest factor corrections:

For a crest factor of 1.0–2.0, add 3.0% to the accuracy.

For a crest factor of 2.0–2.5, add 5.0% to the accuracy.

For a crest factor of 2.5–3.0, add 7.0% to the accuracy.

**Table 13.3** Frequency (ACA and ACV)

Function	Range	Accuracy
Frequency	10.0~600.0 Hz	± (0.1% + 2 dgt)
	6.000 kHz	
	60.00 kHz	

**Notes:**

**Overload protection:** 1000V (rms) and 600 A (rms)

**Trigger Sensitivity:**

ACV function:

> 6V (rms) at 60.00V range for 10Hz ~ 1kHz

> 60V (rms) at 600.0V range for 10Hz ~ 1kHz

> 600V (rms) at 1000V range for 10Hz ~ 1kHz

Hz function at ACV rotary switch:

> 6V (rms) for 10Hz ~ 10kHz

> 30V (rms) for 10kHz ~ 60kHz



ACA function:

> 6A (rms) at 60.00A range for 10Hz ~ 1kHz

> 60A (rms) at 600.0A range for 10Hz ~ 1kHz

Hz function at ACA rotary switch:

> 6A (rms) for 10Hz ~ 10kHz

**Table 13.4** Inrush current

Function	Range	Accuracy
ACA Inrush	60.00 A	±(3% + 0.3 A)
	600.0 A	±(3% + 5 dgt)

Inrush current detection threshold: 0.5A for 60A range and 5.0A for 600.0A range

Overload protection: 1000 V (rms), 600 A (rms).

Integration time is 100 ms.

**Table 13.5** Resistance, Continuity, and Diode

Function	Range	Accuracy
Resistance	600.0 Ω	±(1.0% + 5 dgt)
	6.000 KΩ	
Continuity	600.0 Ω	±(1.0% + 5 dgt)
Diode	1.5V	±(1.5% + 5 dgt)

Overload protection: 1000 V (rms).

Maximum test current: Approx. 0.1 mA.

Maximum open circuit voltage for Ω: Approx. 1.8 V.

Maximum open circuit voltage for diode: Approx. 1.8 V.

Continuity threshold:

< 30 Ω beeper on.

> 150 Ω beeper off.

Continuity indicator: 2.7 kHz tone buzzer.

Continuity response time: <100 ms.

**Table 13.6** Capacitance

Function	Range	Accuracy
Capacitance	1 $\mu$ F to 1000 $\mu$ F	$\pm(1.0\% + 4 \text{ dgt})$

Overload protection: 1000 V (rms).

**Table 13.7** Flex Clamp Adaptor Function

Function	Range	Accuracy
Flex (ACA)	30.00 A	$\pm(1\% + 5 \text{ dgt})$ 45 ~ 400Hz
	300.0 A	
	3000 A	

LCD displays '0' counts when the reading is < 10 counts

Additional accuracy for the Flex function is listed in the FLIR clamp adaptor User Manuals (Models TA72\_TA74).

**Table 13.8** Flex Clamp Adaptor Function (Frequency)

Function	Range	Accuracy
Frequency (Flex)	600.0 Hz	$\pm(0.1\% + 2 \text{ dgt})$
	6.000 kHz	
	10.00 kHz	

Sensitivity:

Flex function:

- > 3A (rms) at 30.00A range for 10Hz ~ 1kHz
- > 30A (rms) at 300.0A range for 10Hz ~ 1kHz
- > 300A (rms) at 3000A range for 10Hz ~ 1kHz

Hz function at Flex rotary switch:

- > 3A (rms) for 10Hz ~ 10kHz
- > 6A (rms) for 10kHz ~ 60kHz

#### Work Lights

- Color Temperature: 4000-5000°K
- Beam Angle:  $\pm 20^\circ$
- Light Output: 70 lumens, minimum
- Power: 0.5 Watt RMS

## **14. Technical Support**

---

Technical Support Website	
---------------------------	--

## ***15. Warranty***

---

### **15.1 FLIR Limited 10-year Warranty**

This product is protected by FLIR's Limited 10-Year Warranty. Visit [document](#).