

**BX-500**

# **REED**

## **INSTRUMENTS**

# **Infrared Temperature Calibrator**



**Instruction  
Manual**



[www.REEDINSTRUMENTS.com](http://www.REEDINSTRUMENTS.com)

.800.561.8187

[www.itm.com](http://www.itm.com)

[information@itm.com](mailto:information@itm.com)

# Table of Contents

Introduction .....	3
Product Quality.....	3
Safety .....	3-4
Features.....	4
Specifications.....	5
Included.....	5
Environmental Conditions .....	6
Instrument Description .....	7-8
Status Indicator Description.....	8
Keypad Description.....	9
Operating Instructions.....	9-12
<i>Initial Start Up</i> .....	9
<i>Turning Off the Calibrator</i> .....	10
<i>Selecting Temperature Unit of Measure</i> .....	10
<i>Setting the Temperature Set-Point</i> .....	10
<i>Setting Overload Alarms 1 &amp; 2</i> .....	11
<i>Enabling/Disabling the Heating Power</i> .....	11
<i>Keypad Lock/Unlock</i> .....	12
Replacing the Fuses.....	12
Product Care .....	13
Accessories and Replacement Parts .....	13
Applications.....	13
Product Warranty .....	13
Product Disposal and Recycling .....	14
Product Support .....	14

## Introduction

Thank you for purchasing your REED BX-500 Infrared Temperature Calibrator. This calibrator provides accurate temperatures to calibrate non-contact temperature instruments. The BX-500 is capable of generating temperatures up to 932°F (500°C) and is designed to accommodate various infrared thermometers. Please read the following instructions carefully before using your instrument. By following the steps outlined in this manual your meter will provide years of reliable service.

## Product Quality

This product has been manufactured in an ISO 9001 facility and has been calibrated during the manufacturing process to meet stated product specifications. If a certificate of calibration is required please contact the nearest authorized REED distributor or authorized Service Center. Please note an additional fee for this service will apply.

## Safety

This instrument can generate extreme temperatures. Precautions must be taken to prevent personal injury or damage to objects. To avoid personal injury read and follow these guidelines.

- Never attempt to repair or modify your instrument.
- Dismantling your instrument other than for the purpose of replacing fuses may cause damage that will not be covered under the manufacturer's warranty. Servicing should only be provided by an authorized Service Center.
- Do not touch the Infrared target surface of the instrument.
- The top casing of the instrument may exhibit high temperatures for areas close to the Infrared target surface.
- Do not turn off the instrument at high temperatures. Select a set-point less than 212°F (100°C) and allow the unit to cool before turning it off.
- Do not operate this unit without a properly grounded, properly polarized power cord.

*continued...*

**REED**

[www.REEDINSTRUMENTS.com](http://www.REEDINSTRUMENTS.com)

**3**

**.800.561.8187**

[www.itm.com](http://www.itm.com)

[information@itm.com](mailto:information@itm.com)

- High voltage is used in the operation of this equipment. Severe injury or death may result if one fails to observe safety precautions.
- Always replace the fuse with one of the same rating, voltage, and type.
- Overhead clearance is required. Do not place this instrument under a cabinet or other structure.
- Do not operate near flammable materials.
- Use of this instrument at high temperatures for extended periods of time requires caution.
- Components and heater lifetime can be shortened by continuous high temperature operation.
- Do not use fluids to clean the target surface.

## Features

- For calibrating non-contact temperature instruments (infrared thermometers, pyrometers and thermal imagers)
- Wide aperture compensates for optical infrared thermometer variations
- Contact RTD reference well located directly behind the blackbody target to assure accurate results

## Specifications

Temperature Range:	122 to 932°F (50 to 500°C)
Accuracy:	≤212°F (100°C): ±1.6°F (0.8°C) 212 to 392°F (100 to 200°C): ±3.2°F (1.6°C) 392 to 932°F (200 to 500°C): ±5.6°F (2.8°C)
Stability:	≤212°F (100°C): ±0.2°F (0.1°C) 212 to 392°F (100 to 200°C): ±0.4°F (0.2°C) 392 to 932°F (200 to 500°C): ±0.8°F (0.4°C)
Resolution:	0.1°F (0.1°C)
Target Emissivity:	0.95 (Fixed)
Heating Time:	Approximately 30 mins to maximum
Cooling Time:	Approximately 30 mins to 122°F (100°C)
Aperture Diameter:	2.28" (58mm)
Display:	Dual LED
Power Supply:	110VAC, 2.5A
Product Certifications:	CE
Operating Temperature:	41 to 95°F (5 to 35°C)
Storage Temperature:	-4 to 140°F (-20 to 60°C)
Operating Humidity:	15 to 80%
Dimensions:	7.1 x 4.5 x 8.8" (180 x 114 x 233mm)
Weight:	6.6lbs (3kg)

## Included

- Power Cord

## Environmental Conditions

This instrument should not be operated in an excessively dusty or dirty environment and operates safely under the following conditions:

- Temperature range: 41 to 95°F (5 to 35°C)
- Ambient relative humidity: 15 to 80%
- Pressure: 75 to 106kPa
- Mains voltage within  $\pm 10\%$  of nominal
- Temperature difference between the target surface and the RTD PT100 reference well located directly behind the target surface are calculated as shown in the graph below.

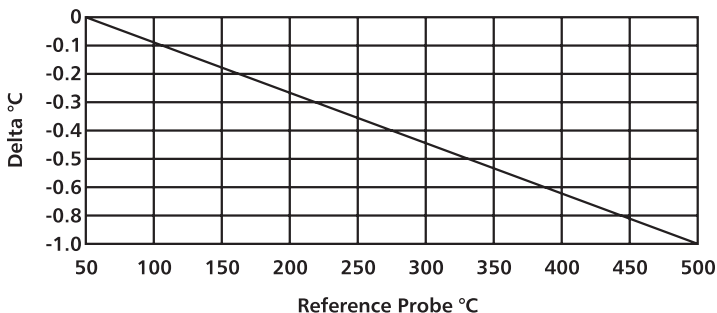

# Instrument Description

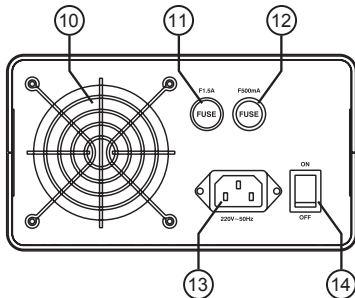
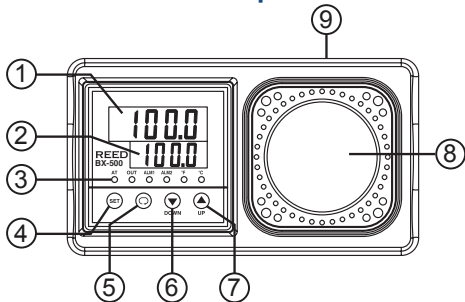

- |  |   |
|--|---|
| 1. Temperature Indicator (Red LED)       | 8. Infrared Target Surface                            |
| 2. Set Temperature Indicator (Green LED) | 9. RTD Reference Well (For Calibration Purposes Only) |
| 3. Status Indicators                     | 10. Fan   |
| 4. Set Button                            | 11. Heating System Fuse                               |
| 5. Return Button                         | 12. Control System Fuse                               |
| 6. Down Arrow                            | 13. Power Socket                                      |
| 7. Up Arrow                              | 14. Power Switch                                      |

*continued...*

**REED**

[www.REEDINSTRUMENTS.com](http://www.REEDINSTRUMENTS.com)

7

.800.561.8187

[www.itm.com](http://www.itm.com)

[information@itm.com](mailto:information@itm.com)

**Note:** The fan inside the calibrator has two speeds and runs continuously when the unit is in operation. The fan runs slow for heating and maintaining operation and runs fast for rapid cooling. The area around the calibrator must be kept clear to allow adequate ventilation. The airflow is directed out the front and can be extremely hot.

## Status Indicator Description

**Note:** Using any other parameter other than the ones described in this manual will affect performance and could damage the calibrator.







<b>AT</b>	Auto-Tuning Parameter Adjustment (For Authorized Service Centers Only).
<b>OUT</b>	Heating Output Power Indicator.
<b>ALM1</b>	Overload Alarm indicates that the IR Calibrator temperature exceeds the set temperature. To set the alarm, refer to <i>Setting Overload Alarms 1 &amp; 2</i> for details. <b>Note:</b> When triggered the heating output power is turned off.
<b>ALM2</b>	Overload Alarm indicates that the IR Calibrator temperature exceeds the set temperature. To set the alarm, refer to <i>Setting Overload Alarms 1 &amp; 2</i> for details. <b>Note:</b> When triggered, the rapid cooling process will begin.
<b>°F/°C</b>	Temperature unit of measure.



## Keypad Description

The four button keypad allows for easy set-point temperature. The temperature set-point can be set to a resolution of 0.1°F or °C.

	<p>The <b>SET</b> button is used to confirm the selected value within the parameter and to exit the set up mode and resume normal operation.</p> <p><b>Note:</b> At any time, you can press the <b>SET</b> button to exit the Setup mode and resume normal operation.</p>
	<p>The enter button is used to scroll through parameters.</p>
	<p>The up arrow is used to increase temperature values and to toggle between menu options within the selected parameter.</p>
	<p>The down arrow is used to decrease temperature values and to toggle between menu options within the selected parameter.</p>

## Operating Instructions

### Initial Start up

1. Place the calibrator on a flat surface with at least 8" of free space around the instrument.
2. Connect the included power cord and plug into a power outlet.
3. Turn the calibrator on by toggling the power switch to ON.
4. The fan should begin blowing air through the instrument.
5. After a brief 3 second self-test, the calibrator will begin normal operation by displaying both the current target surface temperature and the last registered set temperature.

**Note:** When the calibrator is first powered ON, the default set temperature is set to 50°C. Refer to *Setting the Temperature Set-Point* for details.

6. The calibrator will now heat up to reach the registered set temperature.

**Note:** The top display (Green LED) will continue to update the current temperature until the set temperature is reached.

*continued...*

**REED**

www.REEDINSTRUMENTS.com

9

.800.561.8187

www.itm.com

information@itm.com









## Turning Off the Calibrator

It is recommended to select a set-point less than 140°F (60°C) and allow the unit to cool down before turning it off.





**Warning:** Do not turn the instrument off at a temperature higher than 212°F (100°C). Lower the temperature below 212°F (100°C) before powering off.

## Selecting Temperature Unit of Measure

When the meter is first powered on the default scale setting is set to Celsius (°C) and the parameters are locked. In order to change the temperature scale and unlock parameters, follow the steps below.

1. To unlock, hold down both the **SET** and  buttons simultaneously and release when the display indicates "At" & "oFF" confirming that the parameters are now unlocked.
2. Press the **SET** button for three seconds and release to enter the setup mode as indicated by  and .
3. Press  button once and the display will indicate  and  which confirms the current temperature scale.
4. Use the  and  arrows to select between °C and °F.
5. Press the **SET** button to confirm selection.
6. Press the **SET** button again to exit set up mode and resume normal operation.

## Setting the Temperature Set-Point

1. Use the  and  arrows to increase or decrease the temperature set-point value.
2. Press the  arrow to increase the temperature value.
3. Press the  arrow to decrease the temperature value.
4. Press the **SET** button to confirm the new temperature set-point.
5. Press the **SET** button again to exit set up mode and resume normal operation.

*continued...*

**REED**

www.REEDINSTRUMENTS.com

10

.800.561.8187

www.itm.com







information@itm.com

## Setting Overload Alarms 1 & 2



The calibrator allows a user to set overload alarms when the calibrator temperature is over the temperature set-point. When set and triggered, **AL1H** will turn off the heating power. When set and triggered, **AL2H** will turn the cooling fan on.

**Note:** The default high overload alarms are set to 5°C (8°F).

These alarms can be set by following the steps below:

1. Press the  button two times until the top screen displays **AL1H**.
2. Use the  and  arrows to change the temperature value which will flash until confirmed.
3. Press the **SET** button to confirm the new high overload alarm 1.
4. Press the  button once to switch to high overload alarm 2 as indicated by **AL2H**.
5. Use the  and  arrows to change the temperature value which will flash until confirmed.
6. Press the **SET** button to confirm the new high overload alarm 2.
7. Press the **SET** button again to exit set up mode and resume normal operation.

## Enabling/Disabling the Heating Power

1. Press the  button once to display the heating power function as indicated by **r-5**.
2. Use the  and  arrows to select between **run** (enable heating power) or **stop** (disable heating power) which will flash until confirmed.





**Note:** The default heating power is set to **run**.

3. Press the **SET** button to confirm selection.
4. Press the **SET** button again to exit set up mode and resume normal operation.

*continued...*

## Keypad Lock/Unlock

The calibrator allows a user to lock/unlock the keypad to avoid unwanted changes to the settings. Follow the steps below to lock or unlock the keypad.

1. Press the  button four times until the screen displays  & .
2. Use the  and  arrows to select between LoC1, LoC2 & oFF which will flash until confirmed.

**Note:** LoC1 will lock all of the keypad buttons, while LoC2 will only lock the  button allowing a user to continue to modify/confirm the set temperature if required.

3. Press the **SET** button to confirm selection.
4. Press the **SET** button again to exit set up mode and resume normal operation.

## Replacing the Fuses

The calibrator must be switched off before attempting to replace fuses.

To replace fuses:

1. Open the faulty fuse compartment by rotating it counter clockwise.
2. Gently slide out the fuse.
3. Replace with the appropriate fuse (see Specifications below) and tighten the compartment back into place.

Fuse Specifications	
Fuse 1	3A/250V
Fuse 2	200mA/250V

This instrument is equipped with operator accessible fuses. If a fuse blows, it may be due to a power surge or failure of an internal component. Replace the fuse once. If the fuse blows again, it is likely caused by failure of an internal component and you should contact an Authorized REED Service Center.

## Product Care

To keep the instrument in good working order we recommend the following:

- Store your product in a clean, dry place.
- Avoid operating the instrument in dirty or dusty environments.
- If the outside of the instrument becomes dirty, it may be wiped clean with a damp cloth and biodegradable cleaner.
- Do not use harsh chemicals on the surface, as it may damage the paint.
- The calibrator should be handled with care. Avoid knocking or dropping the calibrator.

## Accessories and Replacement Parts

### **R8888** Deluxe Hard Carrying Case

Don't see your part listed here? For a complete list of all accessories and replacement parts visit your product page on [www.reedinstruments.com](http://www.reedinstruments.com).

## Applications

Calibrate non-contact temperature instruments; Infrared Thermometers and Thermal Imagers.

## Product Warranty

REED Instruments guarantees this instrument to be free of defects in material or workmanship for a period of one (1) year from date of shipment. During the warranty period, REED Instruments will repair or replace, at no charge, products or parts of a product that proves to be defective because of improper material or workmanship, under normal use and maintenance. REED Instruments total liability is limited to repair or replacement of the product. REED Instruments shall not be liable for damages to goods, property, or persons due to improper use or through attempts to utilize the instrument under conditions which exceed the designed capabilities. In order to begin the warranty service process, please contact us by phone at 1-877-849-2127 or by email at [info@reedinstruments.com](mailto:info@reedinstruments.com) to discuss the claim and determine the appropriate steps to process the warranty.

## Product Disposal and Recycling



Please follow local laws and regulations when disposing or recycling your instrument. Your product contains electronic components and must be disposed of separately from standard waste products.

## Product Support

If you have any questions on your product, please contact your authorized REED distributor or REED Instruments Customer Service by phone at 1-877-849-2127 or by email at [info@reedinstruments.com](mailto:info@reedinstruments.com).

Please visit [www.REEDINSTRUMENTS.com](http://www.REEDINSTRUMENTS.com) for the most up-to-date manuals, datasheets, product guides and software.

*Product specifications subject to change without notice.  
All rights reserved. Any unauthorized copying or reproduction of this manual is strictly prohibited without prior written permission from REED Instruments.*

# REED INSTRUMENTS

## TEST & MEASURE WITH CONFIDENCE



**CHECK OUT OUR LATEST PRODUCTS!**

[www.REEDINSTRUMENTS.com](http://www.REEDINSTRUMENTS.com)

.800.561.8187

[www.itm.com](http://www.itm.com)

[information@itm.com](mailto:information@itm.com)

# REED INSTRUMENTS

TEMPERATURE  
& HUMIDITY



SOUND



MOISTURE



AIR VELOCITY



ELECTRICAL



[www.REEDINSTRUMENTS.com](http://www.REEDINSTRUMENTS.com)

.800.561.8187

[www.itm.com](http://www.itm.com)

[information@itm.com](mailto:information@itm.com)