



AcuLink 810 Data Acquisition Server User's Manual



Copyright © 2019 V1.00

This manual may not be altered or reproduced in whole or in part by any means without the expressed written consent of Accuenergy.



V: 1.0 Revised: May. 2019

ACCUEnergy

The information contained in this document is believed to be accurate at the time of publication, however, Accuenergy assumes no responsibility for any errors which may appear here and reserves the right to make changes without notice. Please ask the local representative for latest product specifications before ordering.

Please read this manual carefully before installation, operation and maintenance of the AcuLink810 series meter. The following symbols in this manual are used to provide warning of danger or risk during the installation and operation of the meters.



Electric Shock Symbol: Carries information about procedures which must be followed to reduce the risk of electric shock and danger to personal health.



Safety Alert Symbol: Carries information about circumstances which if not considered may result in injury or death.

Prior to maintenance and repair, the equipment must be de-energized and grounded. All maintenance work must be performed by qualified, competent accredited professionals who have received formal training and have experience with high voltage and current devices. Accuenergy shall not be responsible or liable for any damages or injuries caused by improper meter installation and/or operation.

ACCUENERGY

V: 1.0 Revised: May. 2019



Table of Contents

1. Overview	4
2. Functional Description	4
2.1 Hardware Specifications	4
2.2 Power	4
2.3 Communication	5
2.4 Inputs	5
2.5 Environment	5
3. Appearance and Dimensions	6
4. Installation	7
4.1 Installation Checklist	7
4.2 Hardware installation	8
4.2.1 Powering the unit	8
4.2.2 RS485 Network	9
4.2.3 Digital Input Setup	10
5. Initializing the AcuLink 810	11
5.1 Accessing the AcuLink 810 Web Interface	11
5.1.1 Method 1 - Direct Connection via Ethernet	11
5.1.2 Method 2 - Using WIFI to connect to the Meters Web Interface	16
6. AcuLink 810 User Interface	18
6.1 Modbus Template	18
6.2 Adding Devices to the AcuLink 810	20
6.2.1 Modbus-TCP/IP	23
6.2.2 Modbus-RTU	23
6.2.3 Modbus Gateway Function	26
Adding Modbus Gateway Device	26
6.3 Viewing Data of Modbus Devices	27
6.3.1 Configuration	29
6.4 Deleting Modbus Devices from AcuLink 810	30

6.5 Alarms	31
6.5.1 How to create alarm.....	31
6.5.2 How to view alarm.....	32
6.6 Digital Inputs	33
6.7 Logs	35
6.7.1 Alarm Logs.....	35
6.7.2 Event Logs	36
6.8 System Settings.....	36
6.9 Date & Time.....	37
6.10 Network Settings	38
6.10.1 WIFI	38
6.10.2 Ethernet 1	40
6.10.3 Ethernet 2.....	41
6.11 Email (SMTP).....	42
6.12 Alarm Notification	43
6.13 Post Channels	43
6.13.1 HTTP Post Method	43
6.13.2 FTP Post Method	44
6.14 Data Logging	45
6.15 AcuCloud	47
6.16 Data Management.....	51
6.16.1 Download Data	51
Delete Data	51
6.16.2 Users Password	52
6.16.3 Firmware Update.....	52
Manual Firmware Update	53
Remote Firmware Update.....	54
6.17 Network Diagnostics	57
7. LED Description.....	61
7.1 AcuMesh LEDs.....	61
7.2 WiFi LEDs	62
7.3 RS485 LEDs.....	62
8. Reset Button.....	63

1. Overview

The AcuLink 810 is an intelligent data acquisition server and gateway that allows users to collect data from all Accuenergy meters, sensors and other third party devices.

The AcuLink collects and logs time-stamped data from connected downstream devices (serial or Ethernet), and is able to store this data locally in non volatile memory. When using Ethernet it is possible to push or pull data using HTTP or FTP protocols as well as pushing data to different web-based energy management systems or any front end software platform. There is no software required for the AcuLink as all configuration is done from the gateways web interface.

2. Functional Description

2.1 Hardware Specifications

- Disk Capacity: 8 GB RAM
- Interval Recording: 1-1440 minutes, user selectable
- LEDs: Power, Ethernet, WiFi, Modbus TX/RX, AcuMesh

2.2 Power

Power Supply: 24VDC, 500mA

NOTE: This unit is to be sourced by a Class 2 power supply with the following output: 24VDC, 500mA min not to exceed 8A.

Isolation: RJ45 Ethernet 1500Vrms
RS485 2500Vrms
Digital Input 5000Vrms

2.3 Communication

- Protocols Supported: Modbus RTU, Modbus TCP, HTTP/HTTPS, FTP, SNMP, SMTP
- LAN: 2 x RJ45 10/100 Ethernet, full half duplex, auto polarity
- WIFI: 802.11 b/g/n, 2.4GHz
- USB: USB expansion port, USB 2.0 Host

2.4 Inputs

Serial Port: RS485 Modbus, supports up to 32 external devices (expandable)

Baud Rate: 9600-115200 bps

Digital Input: 8 pulse counters

Input Voltage Range: 8-28Vdc

Input Current (Max): 8mA

Start Voltage: 15V

Stop Voltage: 5V

Pulse Frequency (Max): 100Hz, 50% Duty Ratio (5ms ON and 5ms OFF)

2.5 Environment

- North America: -25 to 70 degrees Celsius, 90% RH, non-condensing

3. Appearance and Dimensions

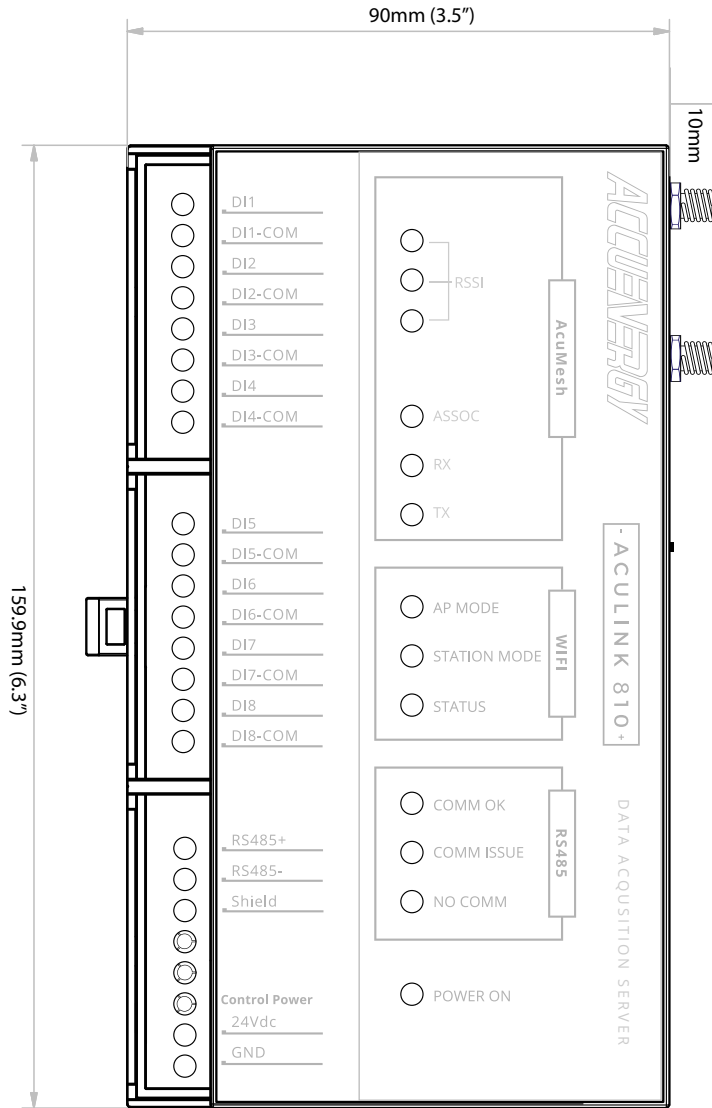

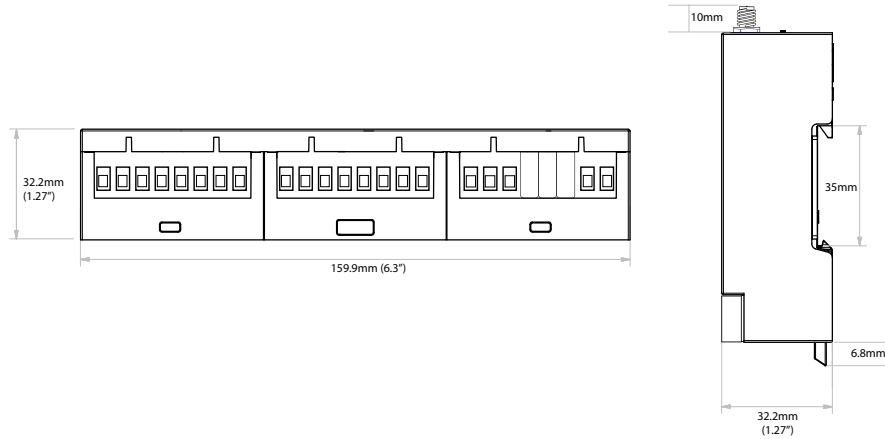

4. Installation

4.1 Installation Checklist

The following materials are required for the AcuLink 810 installation:

- AcuLink 810 Data Acquisition Server
- Ethernet Connection
- Ethernet Cat 5 Cable (Required for LAN or direct computer to AcuLink 810 connection)
- Power Supply (24V)
- WIFI Antenna

Optional Hardware:

- Additional Modbus RTU devices
- 2 wire Modbus/RS485 connection

LAN Information

- Ethernet 10/100MB connection point (router/switch)
- IP address and subnet mask (Check with system administrator)
- Gateway Address (Check with system administrator)
- DNS server address (Check with system administrator)

Chapter 4: Installation

4.2 Hardware installation

The AcuLink 810 is DIN rail mounted, a standard 35 mm DIN rail can be used.

4.2.1 Powering the unit

- The power supply of the AcuLink 810 is rated for 24Vdc.

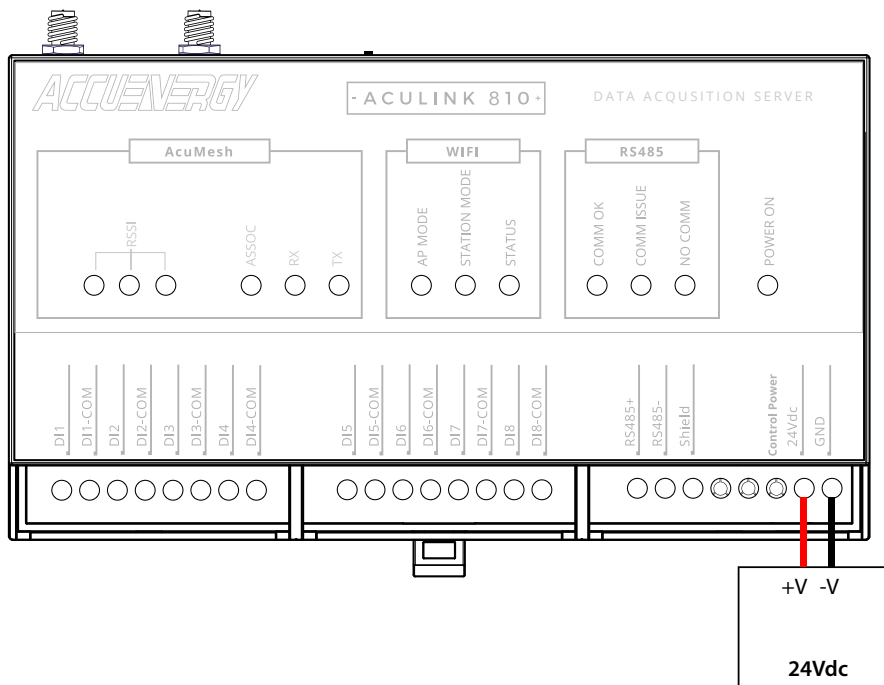

4.2.2 RS485 Network

The AcuLink 810 gateway supports RS485 serial communication. Users can setup an RS485 connection to the AcuLink with any Accuenergy or third party device. If connecting multiple devices or 'daisy chaining' the devices together, ensure that a unique device address (Modbus Slave ID) is configured for each RS485 device. The AcuLink 810 can support up to 32 external RS485 devices.

NOTE: A termination resistor at the end of the RS485 network is optional when daisy chaining multiple devices. If using resistor a termination value of 150 ohms can be used.

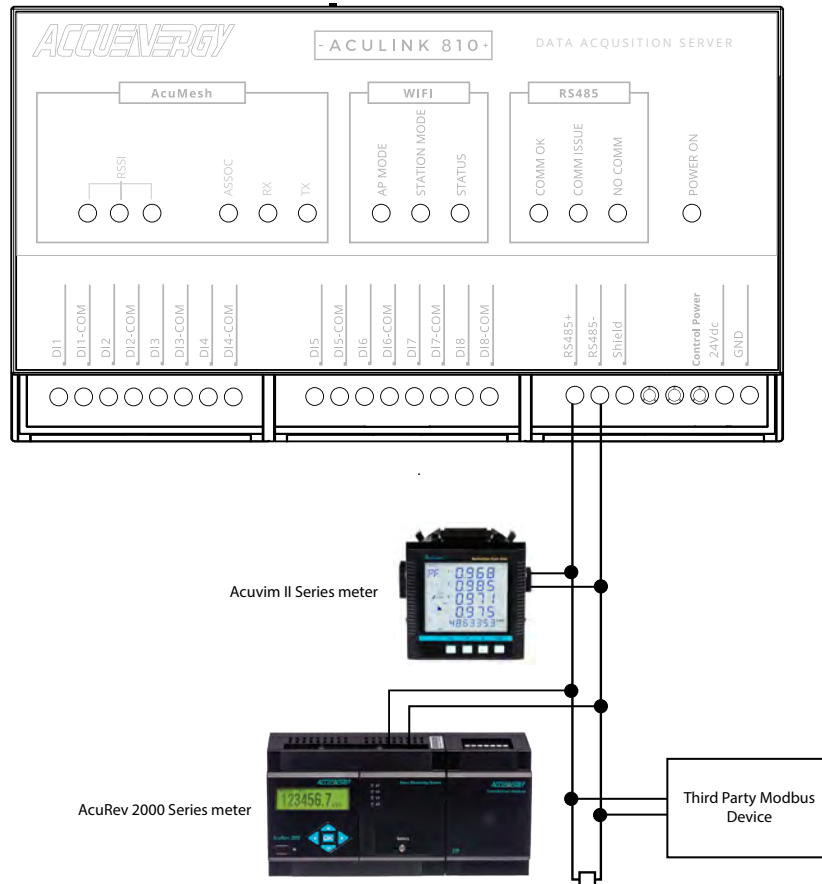

Chapter 4: Installation

4.2.3 Digital Input Setup

The AcuLink 810 has 8 Digital Input channels. Each Digital Input can be used as an input pulse counter.

Each channel has two terminals, a DI terminal and a DI COM terminal. In pulse output circuits a closed loop is required for the pulse to be generated. In the Image below you will see a closed circuit on Digital Inputs 1 and 6. The positive output is connected to the DI channel input and negative output is connected to the DI Common input.

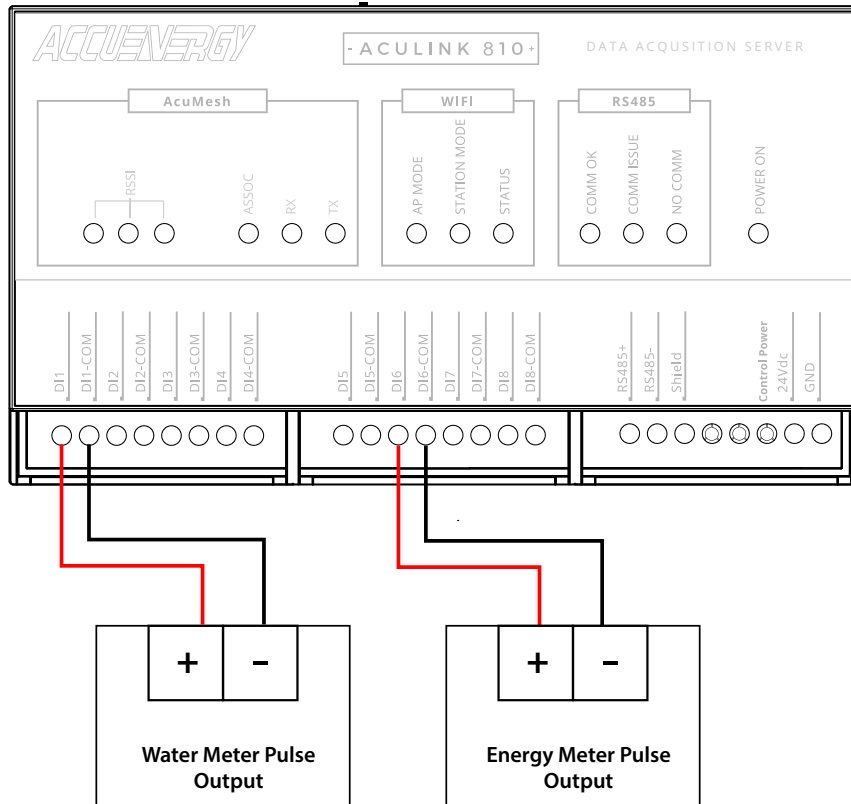

5. Initializing the AcuLink 810

The AcuLink 810 has a web interface that users can access to configure settings and view device data. The AcuLink 810 gateway has two Ethernet ports and also supports communication via WIFI.

The default IP addresses and default modes are:

Ethernet 1: 192.168.8.101

Ethernet 2: DHCP

WIFI: Access Point Mode

The following will outline the methods on how to initially access the meters web interface.

5.1 Accessing the AcuLink 810 Web Interface

5.1.1 Method 1 - Direct Connection via Ethernet

For the direct connection method, there must be an Ethernet connection from the Ethernet 1 port on the AcuLink and a computer.

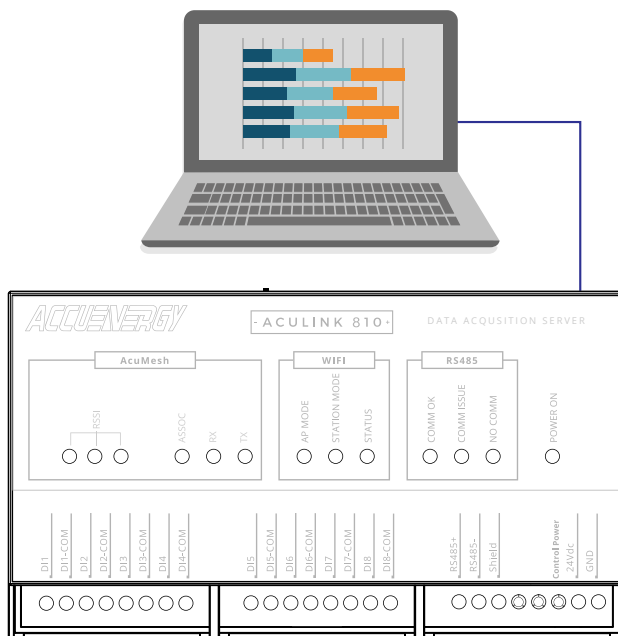

Chapter 5: Initializing the AcuLink 810

Next in order to access the web interface, the computers IP address must be configured within the same subnet as the AcuLink Ethernet 1 IP address. The Ethernet 1 port has a default IP address of 192.168.8.101. The following outlines how to change the computers IP:

- Start by accessing the control panel of the computer and select 'Network and Internet'.

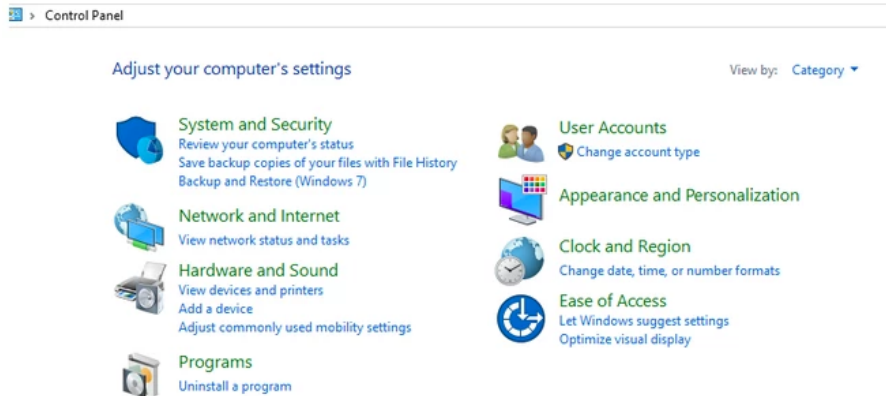

- Select 'Network and Sharing Center'.

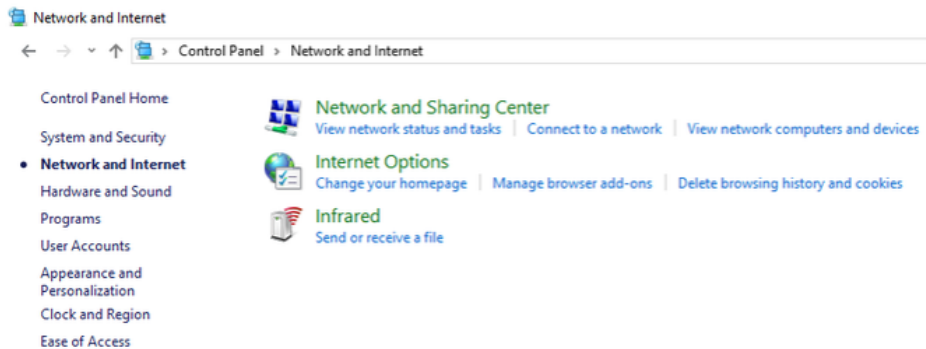

- On the left panel of the screen, select 'Change adapter settings'

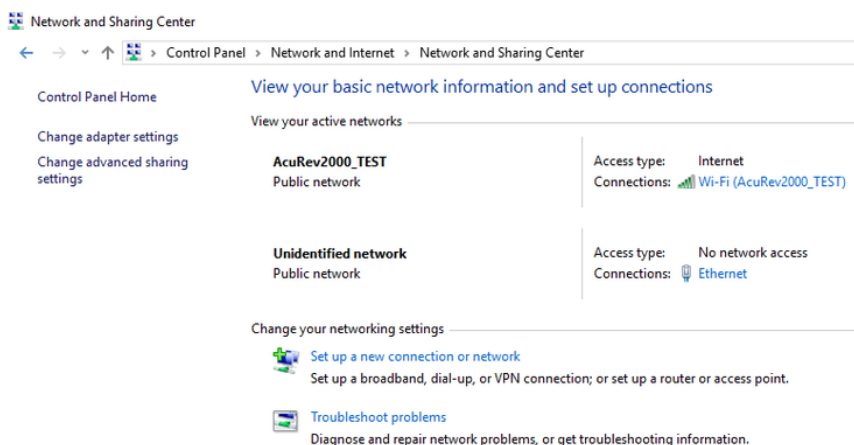

- Double click on 'Ethernet', or right click on 'Ethernet' and select 'Properties'.

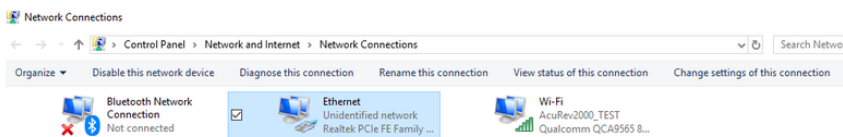

- The following page will open, click on 'Properties'.

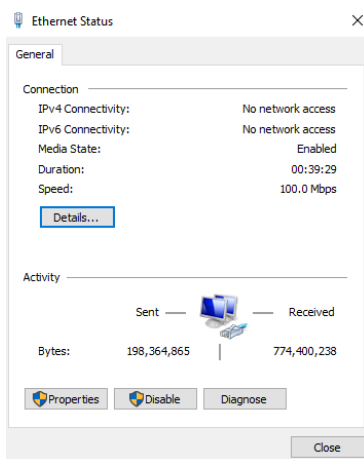

Chapter 5: Initializing the AcuLink 810

- The following page will open, select 'Internet Protocol Version 4 (TCP/IPv4)' and click on 'Properties'.

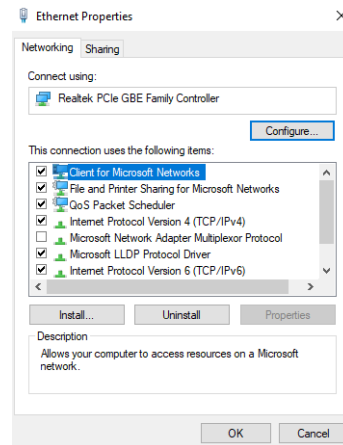

- Select 'Use the following IP address:' and change the IP address of the computer. The AcuLink 810 Ethernet 1 address is 192.168.8.101, the computers IP will need to be within the same subnet. The IP of the computer can be 192.168.8.xxx, where xxx can be any number ranging from 1-254. For the example an IP address of 192.168.8.10 is used.

NOTE: The computers IP address and the AcuLink 810 Ethernet 1 IP address cannot be the same.

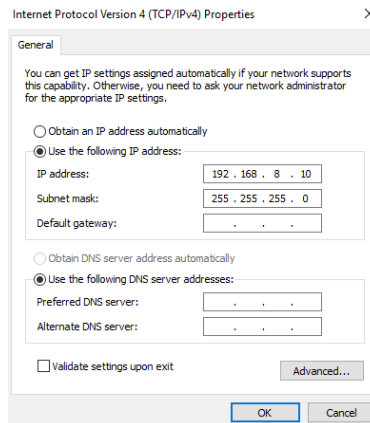

- Once all settings are complete click on 'OK' to confirm the network changes.
- Then open up a internet browser and type in the AcuLink 810 IP address of 192.168.8.101, the following login screen will be prompted.
- There are two Access Levels, 'Viewer' and 'Admin'.
 - Viewer allows users to only view and read data, the password for this user level is viewer.
 - Admin allows users to read data, as well as change and modify all settings of the AcuLink 810, the password for this user level is admin.

NOTE: The recommended internet browsers to access the 810's web interface is Google Chrome, or FireFox.



AcuLink 810 Data Acquisition Server

Sign in to continue

Access Level*

Viewer Admin

Password*

Enter Password here

Sign In

5.1.2 Method 2 - Using WIFI to connect to the Meters Web Interface

The web interface of the AcuLink can be accessed by WIFI. Ensure that the WIFI antenna is installed on the unit.

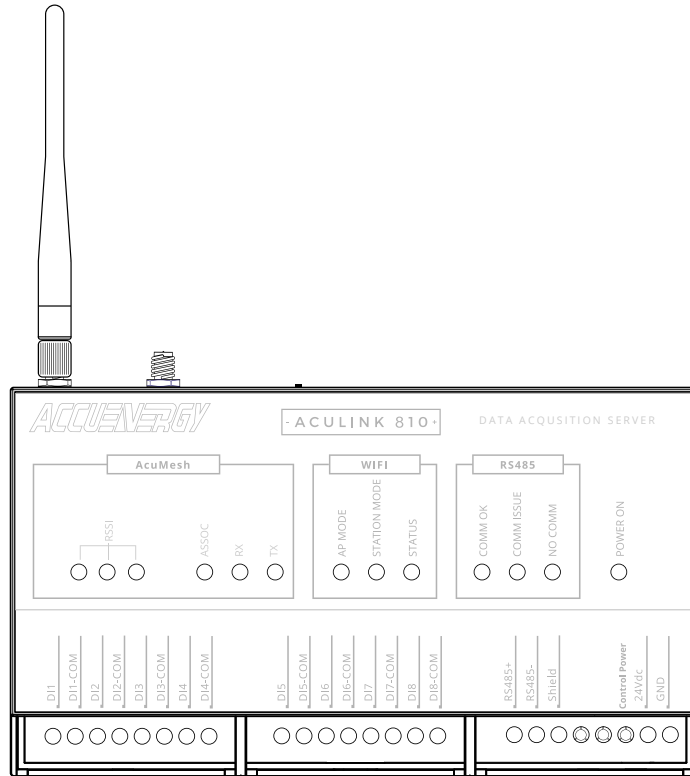

By default the AcuLink 810 has its WIFI mode set as AP (Access Point) mode, where the AcuLink 810 acts as a wireless access point allowing other wireless devices to connect and access the gateway.

To connect to the AcuLink via AP mode, search for the SSID in the list of wireless networks.

The SSID will be by default AcuLink810-WIFI-S8Pxxxxxxx, where the 'S8Pxxxxxxx' is a unique serial number of the AcuLink gateway. The serial number of the AcuLink can be found on the side of the unit. The password for the network is **accuenergy**.

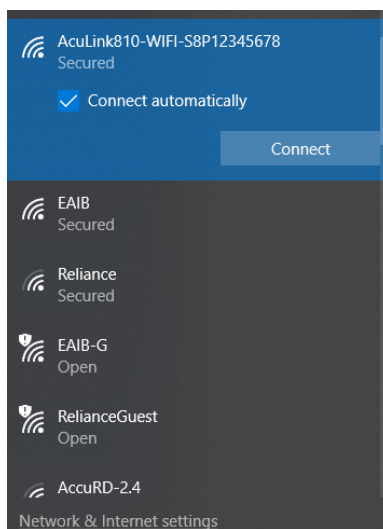

Once connected to the gateways wireless network, open up an internet browser and enter in the IP address **192.168.100.1**. The following login screen will be prompted.

- There are two Access Level, 'Viewer' and 'Admin'.
 - Viewer allows users only to view and read data, the password for this user level is **view**.
 - Admin allows users to read data, as well as change and modify the settings of the Acu-Link 810, the password for this user level is **admin**.

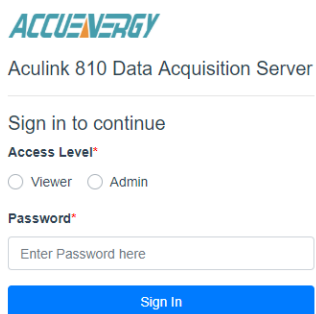

6. AcuLink 810 User Interface

When you log in to the AcuLink 810 web interface, users are directed to the 'Dashboard'. The dashboard provides the user with a summary of all the Offline Devices as well as the Devices in Alarm.

The navigation panel on the left side of the interface allows users to access different settings within the gateway.

The footer on the bottom of the web page includes the server time and date. The footer also includes the time that the gateway was initially powered on.

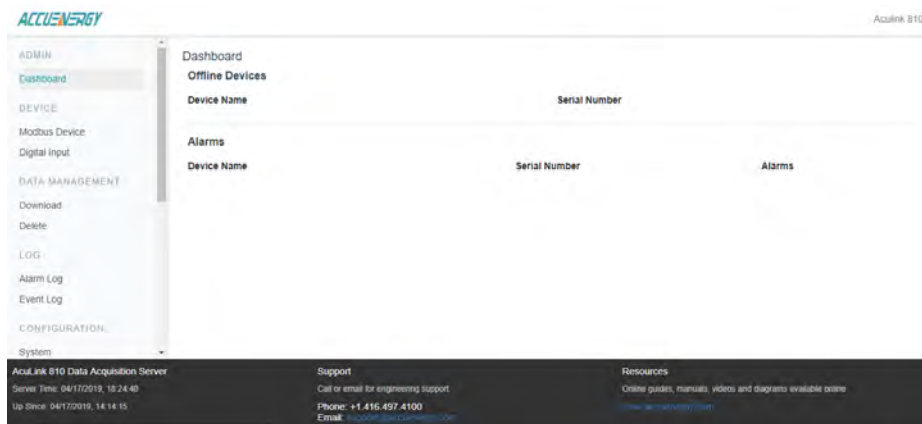

6.1 Modbus Template

Modbus Templates are used in the AcuLink 810 to correctly read the metering data from Accuenergy and third party Modbus devices. Before a device can be added to the gateway a Modbus template for the device must first be uploaded and installed onto the unit.

On the left navigation panel under the 'CONFIGURATION' menu, select 'Modbus Template'.

In the Modbus templates page users can view the templates and the version number currently installed on to the AcuLink under the 'Installed' tab.



To upload a new device template click on the 'New/Update' tab. All Accuenergy device templates can be found in the remote update section of the page. In order to use the remote upload function, users must ensure they have sufficient connection to the Internet.

NOTE: For specific or third party templates please contact Accuenergy Technical Support.

For third party device templates, users can upload and install templates manually.

NOTE: Data log and alarm monitoring configurations will be lost after updating an existing device template.

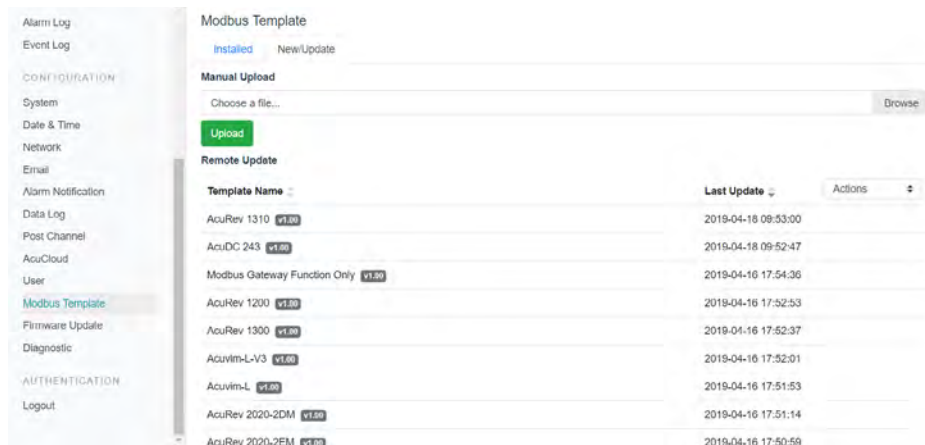

Chapter 6: AcuLink 810 User interface

6.2 Adding Devices to the AcuLink 810

On the left navigation panel of the AcuLink 810 web interface, there is a menu titled 'DEVICE'. In the devices menu there are two options:

1. Modbus Device
2. Digital Input

This is where users can add a Modbus device or configure the digital input on the AcuLink 810 gateway. The user can add devices to the gateway by Modbus RTU, and by Modbus TCP.

Modbus TCP

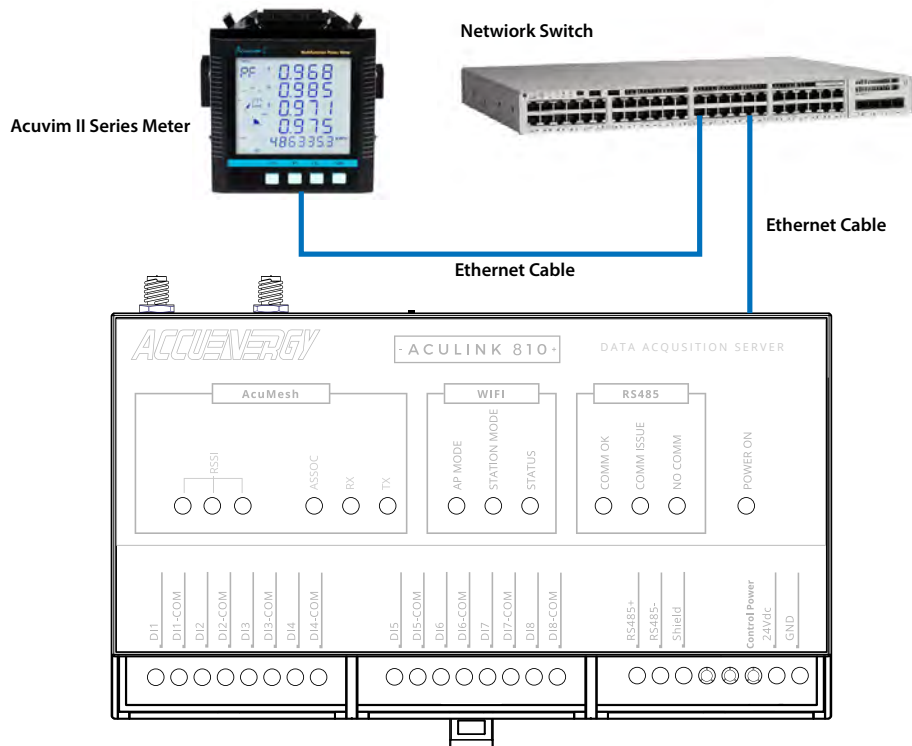

Modbus RTU via RS485

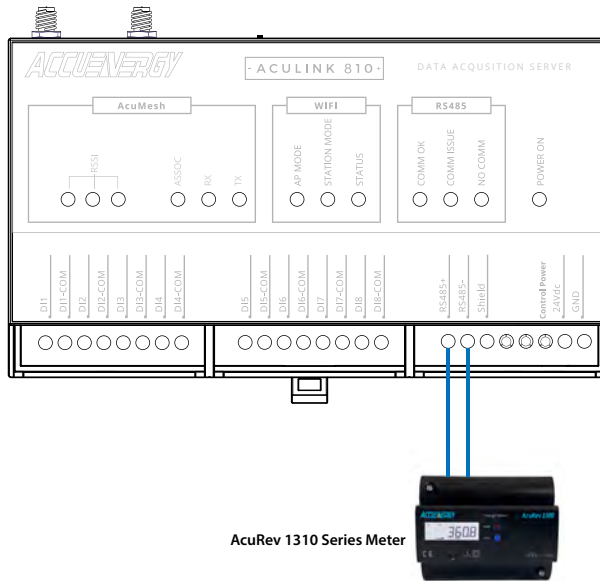

Modbus RTU via USB

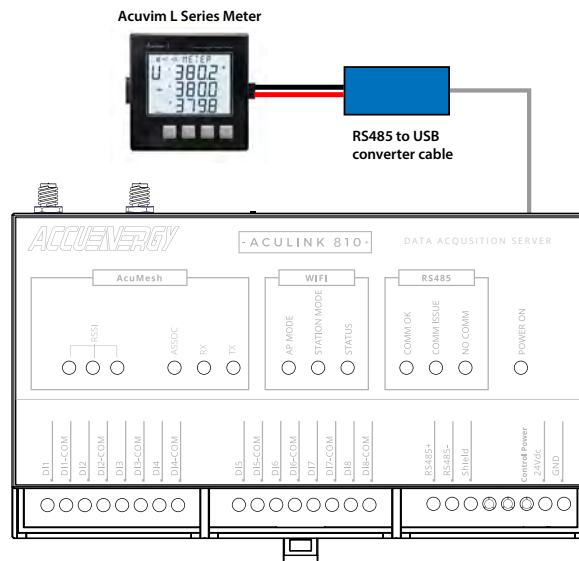

Chapter 6: AcuLink 810 User interface

To add a device to the AcuLink 810, you will need to login under Admin access level.

From the left navigation panel, select 'Modbus Device' under the 'DEVICE' menu.

The user will see all the devices that are currently communicating with the gateway on this page.

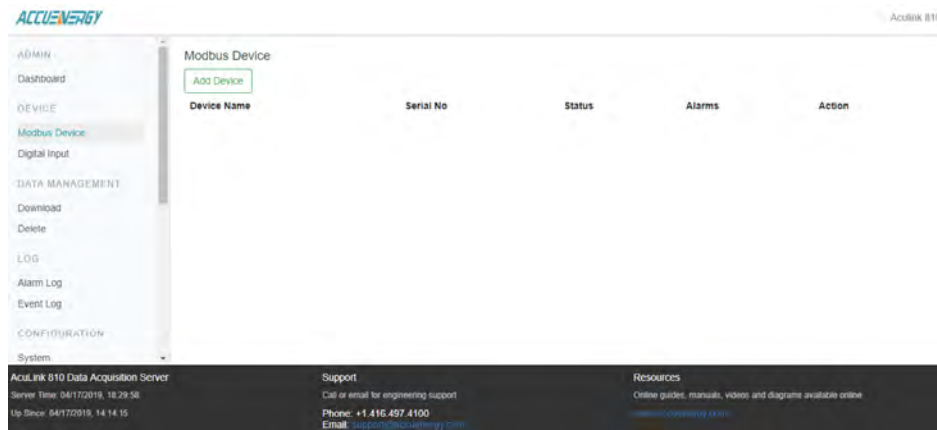

Click on 'Add Device'.

- Provide a name for the Device under the Device Name field
- Enter the Serial Number for the Device
- Select the Model of the Device from the Device Model drop down list
- Enter the Request Timeout from 1-60 sec.

NOTE: Users cannot add two devices with the same serial number. Each serial number must be unique for each device.

Select the Protocol

- **RTU** - Serial communication via RS485, USB, or AcuMesh
- **TCP** - Communication using TCP over Ethernet or WiFi

ACCUENERGY

ADMIN
Dashboard

DEVICE
Modbus Device
Digital Input

DATA MANAGEMENT
Download
Delete

LOG
Alarm Log

Add Modbus Device

Device Name*
Enter Device Name here

Serial Number*
Enter Serial Number here
Must be unique in this AcuLink 810 device

Device Model*
-- Please select Device Model --

Protocol*
 RTU TCP

6.2.1 Modbus-TCP/IP

With the Modbus TCP/IP protocol selected, configure the following fields:

- **IP Address:** Enter the IP address of the device
- **Port:** Enter the Modbus port of the device
- **Modbus ID:** Enter the Modbus address of the device
- **Request Timeout:** Enter the timeout setting, default for TCP is 3 seconds

Click 'Submit' once all settings are entered in correctly.

ACCUENERGY

ADMIN
Dashboard

DEVICE
Modbus Device
Digital Input

DATA MANAGEMENT
Download
Delete

LOG
Alarm Log
Event Log

CONFIGURATION
System

Protocol*
 RTU TCP

IP Address*
Enter IP Address here

Port*
Enter Port here

Modbus ID*
Enter Modbus ID here

Request Timeout*
3 seconds
0-1499

Submit Cancel

6.2.2 Modbus-RTU

With the Modbus RTU protocol selected, configure the following fields:

Address: Enter the device address (Modbus Slave ID) of the meter, range is from 1-247

Chapter 6: AcuLink 810 User interface

Port: Users can select either RS485 or USB

Baud Rate: Select the baud rate of the device, range is from 9600-115200

Data Bit: Select the number of data bits, either 7 or 8

Parity: Select the parity of the device from the drop down list

Stop Bit: Select the number of Stop Bits

Request Timeout: Select a timeout period for the AcuLink 810 to wait for a response from the device, range is 1-60 seconds, default for Modbus RTU is 0.5.

NOTE: Users cannot add device with the same device address (Modbus Slave ID). The device address must be unique for each device in the RS485 network.

Click 'Submit' once all settings are entered in correctly.

The screenshot displays the 'CONFIGURATION' page of the AcuLink 810 user interface. The left sidebar lists various configuration categories: System, Date & Time, Network, Email, Alarm Notification, Data Log, Post Channel, AcuCloud, User, Modbus Template, Firmware Update, and Diagnostic. The main content area is divided into two sections. The top section shows the 'Protocol' set to 'RTU' (selected) and 'TCP' (unselected). Below this, the 'Port' is set to 'RS485'. The 'Modbus ID' field is empty, with a placeholder text 'Enter Modbus ID here' and a note 'Must be unique in this ACULINK 810 device'. The 'Baud Rate' is set to '38400', 'Data Bit' is '8', 'Parity' is 'None', and 'Stop Bit' is '1'. The 'Request Timeout' is set to '0.5' seconds. The bottom section shows the 'Baud Rate' set to '38400', 'Data Bit' set to '8', 'Parity' set to 'None', 'Stop Bit' set to '1', and 'Request Timeout' set to '0.5' seconds. At the bottom of the form are 'Submit' and 'Cancel' buttons.

After the device is added, it can be found in the 'Modbus Devices' section under the 'DEVICE' menu

Device Name	Serial No	Status	Alarms	Action
AcuDC 243 RTU	AcuDC243RTU	ON	0	[Action]
AcuRev 1312 RTU	AcuRev1312RTU	ON	0	[Action]
AcuRev 2020 RTU	AcuRev2020RTU	ON	0	[Action]
Acuwin II USB	AcuWinIIUSB	ON	0	[Action]
AcuRev 2020 TCP	AcuRev2020TCP	ON	0	[Action]
Acuwin II TCP	AcuWinIITCP	ON	0	[Action]
Acuwin L RTU	AcuwinLRTU	ON	0	[Action]
Acuwin L V3 TCP	AcuwinLV3TCP	ON	0	[Action]

A device that is successfully connected and communicating with the gateway will have a green 'ON' mark under the status column. While a device that is offline will display a red 'OFF' warning symbol.

NOTE: After adding a new device to the gateway it may take up to 3-4 minutes for the status to show 'ON'. If after 3-4 minutes the device is showing a 'OFF' status, double check the configuration settings to ensure everything is set correctly.

Device Name	Serial No	Status	Alarms	Action
AcuDC 243 RTU	AcuDC243RTU	ON	0	[Action]
AcuRev 1312 RTU	AcuRev1312RTU	ON	0	[Action]
AcuRev 2020 RTU	AcuRev2020RTU	ON	0	[Action]
Acuwin II USB	AcuWinIIUSB	ON	0	[Action]
AcuRev 2020 TCP	AcuRev2020TCP	ON	0	[Action]
Acuwin II TCP	AcuWinIITCP	OFF	0	[Action]
Acuwin L RTU	AcuwinLRTU	ON	0	[Action]
Acuwin L V3 TCP	AcuwinLV3TCP	ON	0	[Action]

6.2.3 Modbus Gateway Function

The AcuLink 810 supports a Modbus Gateway Function, where users can add a Modbus RTU device and use it as a gateway. Users must choose the device template as 'Modbus Gateway Function Only'.

The Modbus Gateway Function allows users to forward a Modbus TCP request to the corresponding meter.

Adding Modbus Gateway Device

To add a Modbus Gateway device, select add device. Under the 'Device Model' select 'Modbus Gateway Function Only'. Select 'RTU' as the protocol and enter in the communication settings for that RTU device (baud rate, parity, Modbus ID, etc). Click on 'Submit' once all information is entered in correctly.

NOTE: Only Modbus RTU devices can be used as a Modbus Gateway Function on the AcuLink 810.

The screenshot shows the 'Modbus Device' configuration page in the AcuLink 810 user interface. The left sidebar contains navigation menus for ADMIN, DEVICE, DATA MANAGEMENT, LOG, and CONFIGURATION. The main content area is a form with the following fields:

- Device Name***: Gateway
- Serial Number***: 123456
Must be unique in this AcuLink 810 device.
- Device Model***: Modbus Gateway Function Only
- Protocol***: RTU (selected), TCP
- Port***: RS-485
- Modbus ID***: 25
Must be unique in this AcuLink 810 device.
- Baud Rate***: 38400
- Data Bit***: 8
- Parity***: None

At the bottom of the form are 'Submit' and 'Cancel' buttons.

Once the gateway device is added there will be a gateway symbol under the 'Status' column on the Modbus Devices page.

Device Name	Serial No	Status	Alarms	Action
AcuDC 243	AcuDC243	ON	1	[Edit] [Delete]
AcuRev2020 RTU	AcuRev2020RTU	OFF	0	[Edit] [Delete]
AcuRev II RTU	AcuRevII RTU	ON	0	[Edit] [Delete]
AcuRev II TCP	AcuRevII TCP	OFF	0	[Edit] [Delete]
AcuRev II USB	AcuRevII USB	ON	0	[Edit] [Delete]
AcuRev L RTU	AcuRevL RTU	ON	0	[Edit] [Delete]
AcuRev L VS	AcuRevL VS	OFF	0	[Edit] [Delete]
Gateway Test	Gateway	Gateway	0	[Edit] [Delete]

6.3 Viewing Data of Modbus Devices

To view the readings from your device, select 'Modbus Devices' on the left panel under the 'DEVICES' menu. On this page, all the Modbus devices added to the AcuLink 810 will appear here. It will display the Device name, the serial number, status (offline or online) and the number of alarms triggered for the device.

Device Name	Serial No	Status	Alarms	Action
AcuDC 243 RTU	AcuDC243RTU	ON	0	[Edit] [Delete]
AcuRev 1312 RTU	AcuRev1312RTU	ON	0	[Edit] [Delete]
AcuRev 2020 RTU	AcuRev2020RTU	ON	0	[Edit] [Delete]
AcuRev II USB	AcuRevII USB	ON	0	[Edit] [Delete]
AcuRev 2020 TCP	AcuRev2020TCP	ON	0	[Edit] [Delete]
AcuRev II TCP	AcuRevII TCP	OFF	0	[Edit] [Delete]
AcuRev L RTU	AcuRevL RTU	ON	0	[Edit] [Delete]
AcuRev L VS TCP	AcuRevL VS TCP	ON	0	[Edit] [Delete]

Chapter 6: AcuLink 810 User interface

Select the device you wish to view the data for. The following Device page will open.

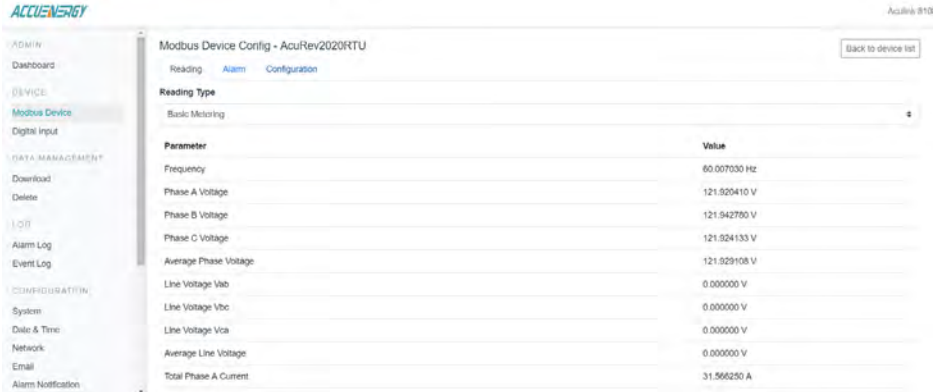

Modbus Device Config - AcuRev2020RTU

Reading Alarm Configuration

Reading Type: Basic Metering

Parameter	Value
Frequency	60.007030 Hz
Phase A Voltage	121.920410 V
Phase B Voltage	121.942780 V
Phase C Voltage	121.924133 V
Average Phase Voltage	121.929108 V
Line Voltage Vab	0.000000 V
Line Voltage Vbc	0.000000 V
Line Voltage Vca	0.000000 V
Average Line Voltage	0.000000 V
Total Phase A Current	31.560250 A

The Device data can be viewed on the 'Reading' tab.

In the Readings tab users can view the meters real time data. In the drop down menu there are options to select the different categories of the real time data. Each drop down menu will vary depending on the device template chosen for the device.

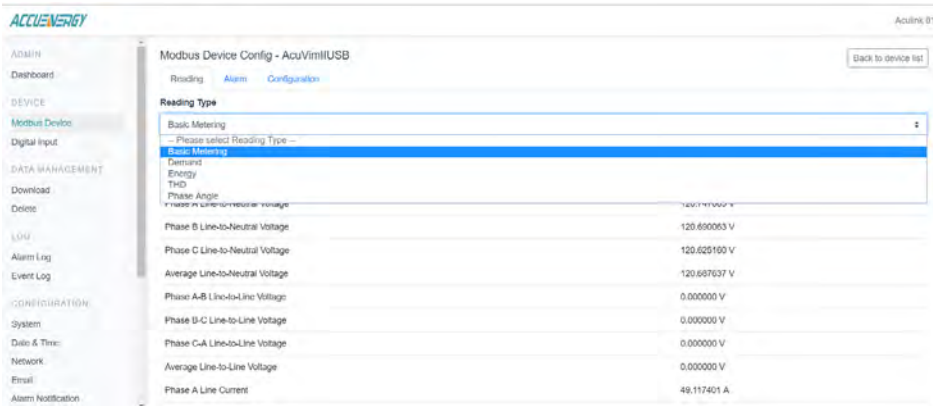

Modbus Device Config - AcuVimilUSB

Reading Alarm Configuration

Reading Type: Basic Metering

Phase A Line-to-Neutral Voltage	120.690000 V
Phase B Line-to-Neutral Voltage	120.690063 V
Phase C Line-to-Neutral Voltage	120.629190 V
Average Line-to-Neutral Voltage	120.687637 V
Phase A-B Line-to-Line Voltage	0.000000 V
Phase B-C Line-to-Line Voltage	0.000000 V
Phase C-A Line-to-Line Voltage	0.000000 V
Average Line-to-Line Voltage	0.000000 V
Phase A Line Current	49.117401 A

The readings have the parameter listed on the left and the value of the parameter listed on the right.

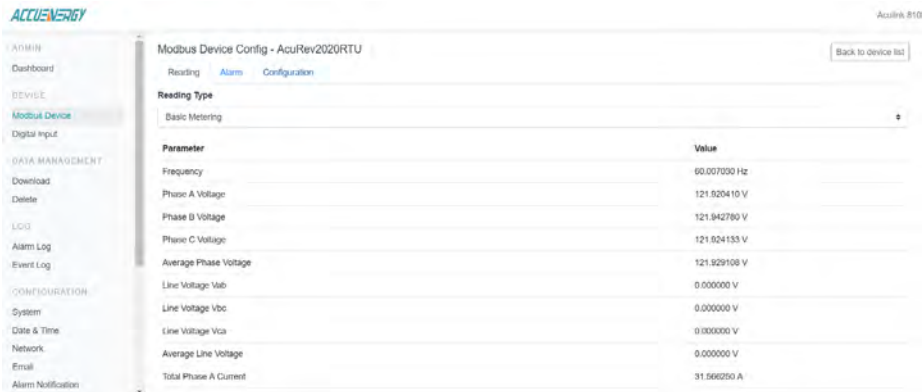

The screenshot shows the 'Reading' tab of the 'Modbus Device Config - AcuRev2020RTU' page. It displays a table with the following data:

Parameter	Value
Frequency	60.007090 Hz
Phase A Voltage	121.020410 V
Phase B Voltage	121.942780 V
Phase C Voltage	121.024133 V
Average Phase Voltage	121.929108 V
Line Voltage Vab	0.000000 V
Line Voltage Vbc	0.000000 V
Line Voltage Vca	0.000000 V
Average Line Voltage	0.000000 V
Total Phase A Current	31.566250 A

6.3.1 Configuration

The configuration page can be used to edit an existing Modbus Device on the AcuLink 810. This can be used to change the IP address or Modbus port of a Modbus TCP/IP device, users can also change the device address, baud rate, etc on an RS485 device.

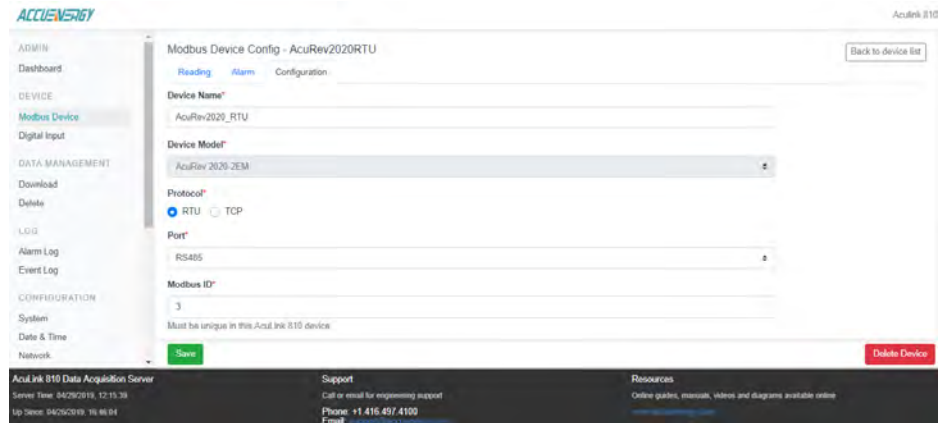

The screenshot shows the 'Configuration' tab of the 'Modbus Device Config - AcuRev2020RTU' page. The fields are as follows:

- Device Name*: AcuRev2020_RTU
- Device Model*: AcuRev 2020-2EM
- Protocol*: RTU TCP
- Port*: RS485
- Modbus ID*: 3

Below the fields, there is a note: "Must be unique in this AcuLink 810 device." At the bottom of the form, there are 'Save' and 'Delete Device' buttons.

Chapter 6: AcuLink 810 User interface

6.4 Deleting Modbus Devices from AcuLink 810

To delete a device on the AcuLink 810 navigate to the 'Modbus Devices' under the 'DEVICES' menu on the left panel of the interface. Then click on the delete icon under the 'Action' column.

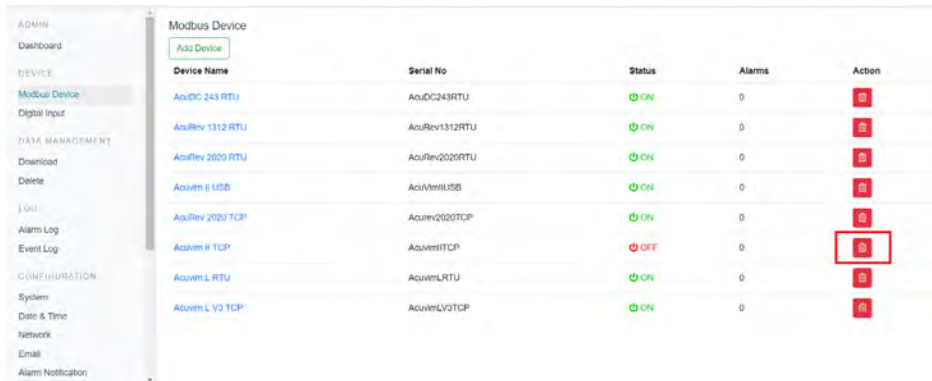

Device Name	Serial No	Status	Alarms	Action
AcuDC 243 RTU	AcuDC243RTU	ON	0	[Delete]
AcuRev 1312 RTU	AcuRev1312RTU	ON	0	[Delete]
AcuRev 2020 RTU	AcuRev2020RTU	ON	0	[Delete]
Acuvin II USB	AcuvinIIUSB	ON	0	[Delete]
AcuRev 2020 TCP	AcuRev2020TCP	ON	0	[Delete]
Acuvin II TCP	AcuvinIITCP	OFF	0	[Delete]
Acuvin L RTU	AcuvinLRTU	ON	0	[Delete]
Acuvin L V3 TCP	AcuvinLV3TCP	ON	0	[Delete]

After selecting delete device, a message will appear asking the user to confirm the delete. Select 'Yes, Delete' to remove the device and all stored data from the AcuLink 810.

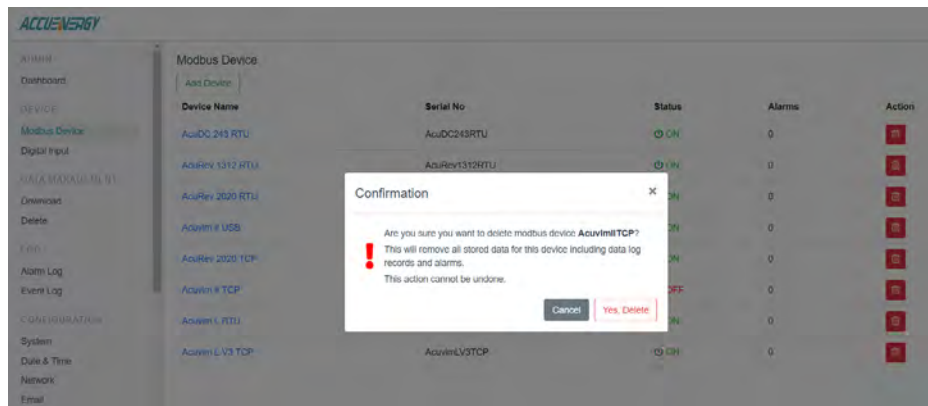

Alternatively users can also delete a device from the gateway by clicking on the device from the 'Modbus Device' page, and then selecting the 'Configuration' tab.

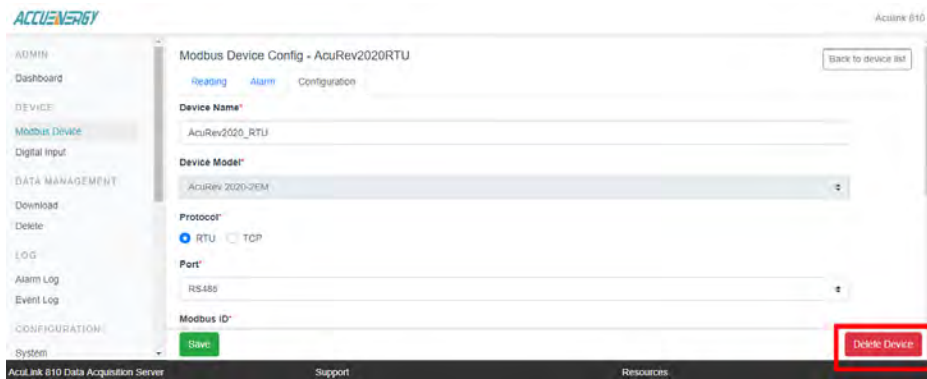

6.5 Alarms

The AcuLink 810 supports alarm monitoring on the Modbus devices connected to it. The gateway allows users to monitor selected parameters using an under/over alarm. When the monitored parameter goes over/under the preset limit, the alarm will be triggered.

6.5.1 How to create alarm

To create an alarm, click on 'Modbus Devices' under the 'DEVICES' menu on the left panel. Select the desired device you want to set the alarm for.

On the Device page, select the 'Alarms' tab. Click on 'Add Alarm'.



Chapter 6: AcuLink 810 User interface

The following settings will need to be configured:

- **Label:** Description of the alarm.
- **Parameter:** In the drop down menu select the parameter to be monitored.
- **Min:** Select the minimum value to trigger the alarm parameter.
- **Max:** Select the maximum value to trigger the alarm parameter.

Click on 'Save' once all settings are entered in correctly.

For example if the parameter selected was 'Frequency' with a minimum threshold of 0 and a maximum threshold of 50, the alarm will be triggered when the frequency is less than or equal to 0 Hz and when the frequency is greater or equal to 50 Hz. Any value outside of the range set will trigger the alarm.

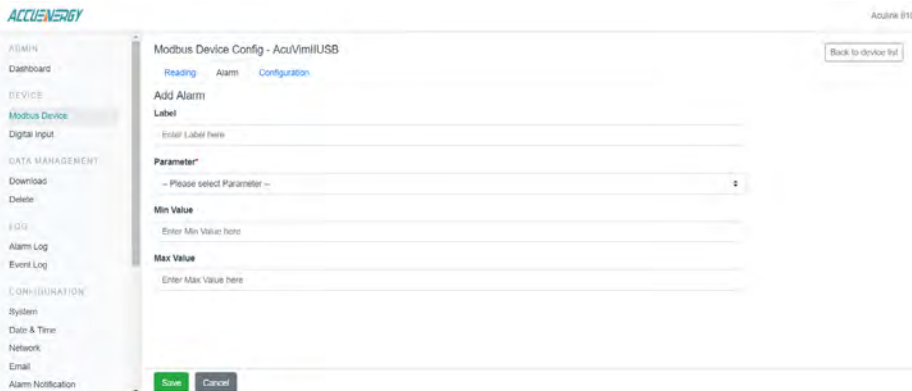

6.5.2 How to view alarm

The Alarm column in the Modbus Device List will show users the number of alarms that have been triggered.

Device Name	Serial No	Status	Alarms	Action
AcuDC 243 RTU	AcuDC243RTU	ON	0	[Edit] [Delete]
AcuRev 1312 RTU	AcuRev1312RTU	ON	0	[Edit] [Delete]
AcuRev 2020 RTU	AcuRev2020RTU	ON	0	[Edit] [Delete]
AcuVim II USB	AcuVimIIUSB	ON	0	[Edit] [Delete]
AcuRev 2020 TCP	AcuRev2020TCP	ON	1	[Edit] [Delete]
AcuVim L RTU	AcuVimLRTU	OFF	0	[Edit] [Delete]
AcuVim L V3 TCP	AcuVimLV3TCP	OFF	0	[Edit] [Delete]

To view the Alarm click on the Device Name, and select the 'Alarms' tab. The alarm page displays the alarm conditions (max and min) as well as the current value of the parameter, the status of the alarm (on or off) and the action for this alarm (edit or delete). The alarms can also be viewed from the Alarm Logs which will be discussed later in the manual.

Users can delete the alarm at any time from this page by clicking on the delete icon on the far right column of the alarm parameter.

Label	Parameter	Min	Max	Value	Status	Action
Voltage Flattine	Average Phase Voltage	10	120	0.000000	ON	[Edit] [Delete]

6.6 Digital Inputs

The AcuLink 810 supports 8 Digital Input channels that can be configured to count pulses. To configure the Digital Input from the web interface click on 'Digital Inputs' under the 'DEVICES' menu on the left panel of the interface.

Chapter 6: AcuLink 810 User interface

Digital Input

[Edit](#)

Digital Input	Description	Count	Reading	Multiplier	Unit
Digital Input 1	Channel 1	0	0.000	1.000	
Digital Input 2	Channel 2	0	0.000	1.000	
Digital Input 3	Channel 3	0	0.000	1.000	
Digital Input 4	Channel 4	0	0.000	1.000	
Digital Input 5	Channel 5	0	0.000	1.000	
Digital Input 6	Channel 6	0	0.000	1.000	
Digital Input 7	Channel 7	0	0.000	1.000	
Digital Input 8	Channel 8	0	0.000	1.000	

Click on Edit to configure the digital input settings.

Digital Input

[Edit](#)

Digital Input	Description	Count	Reading	Multiplier	Unit
Digital Input 1	Channel 1	0	0.000	1.000	
Digital Input 2	Channel 2	0	0.000	1.000	
Digital Input 3	Channel 3	0	0.000	1.000	
Digital Input 4	Channel 4	0	0.000	1.000	
Digital Input 5	Channel 5	0	0.000	1.000	
Digital Input 6	Channel 6	0	0.000	1.000	
Digital Input 7	Channel 7	0	0.000	1.000	
Digital Input 8	Channel 8	0	0.000	1.000	

Enter in a Description and the units the pulses will be representing. A multiplier can be applied to the count if necessary. Users can also input a starting count value to the digital input channel.

Digital Input

[Edit](#)

Digital Input	Description	Count	Reading	Multiplier	Unit
Digital Input 1	Channel 1	<input type="text" value="0"/>	<input type="text" value="0.000"/>	<input type="text" value="1.000"/>	<input type="text" value="Enter Unit 0 here"/>
Digital Input 2	Channel 2	<input type="text" value="0"/>	<input type="text" value="0.000"/>	<input type="text" value="1.000"/>	<input type="text" value="Enter Unit 1 here"/>
Digital Input 3	Channel 3	<input type="text" value="0"/>	<input type="text" value="0.000"/>	<input type="text" value="1.000"/>	<input type="text" value="Enter Unit 2 here"/>
Digital Input 4	Channel 4	<input type="text" value="0"/>	<input type="text" value="0.000"/>	<input type="text" value="1.000"/>	<input type="text" value="Enter Unit 3 here"/>
Digital Input 5	Channel 5	<input type="text" value="0"/>	<input type="text" value="0.000"/>	<input type="text" value="1.000"/>	<input type="text" value="Enter Unit 4 here"/>
Digital Input 6	Channel 6	<input type="text" value="0"/>	<input type="text" value="0.000"/>	<input type="text" value="1.000"/>	<input type="text" value="Enter Unit 5 here"/>
Digital Input 7	Channel 7	<input type="text" value="0"/>	<input type="text" value="0.000"/>	<input type="text" value="1.000"/>	<input type="text" value="Enter Unit 6 here"/>

[Save](#)

Once the Digital Inputs are configured, users can see the count value, the reading value, units and multiplier that is applied to the Digital Input channel.

Digital Input	Description	Count	Reading	Multiplier	Unit
Digital Input 1	Energy	1200	1200.000	1.000	kWh
Digital Input 2	Water	0	0.000	2.500	L
Digital Input 3	Channel 3	0	0.000	1.000	
Digital Input 4	Channel 4	0	0.000	1.000	
Digital Input 5	Channel 5	45	45.000	1.000	
Digital Input 6	Channel 6	0	0.000	1.000	
Digital Input 7	Channel 7	0	0.000	1.000	
Digital Input 8	Channel 8	0	0.000	1.000	

6.7 Logs

6.7.1 Alarm Logs

Users can check the historical data of the triggered alarms by clicking on 'Alarm Log' under 'LOG' menu.

Alarm logs can be filtered by selecting the start time, end time, serial number and monitor ID.

Users can also clear all the alarm logs by clicking on 'Clear Logs'.

Monitor ID	Device Name	Serial Number	Monitor Label	Parameter	Status	Min	Max	Value	Reason	Timestamp
1	AcuRev 2020 TCP	AcuRev2020TCP	Voltage Flatline	Average Phase Voltage / V	▲	0.2	120	0.000	UNDERFLOW	2019-04-25 10:33:38
2	AcuVim II TCP	AcuVimIITCP	Current Flatline	Average Line Current / A	▲	0.2	30	0.000	UNDERFLOW	2019-04-24 12:27:03
2	AcuVim II TCP	AcuVimIITCP	Current Flatline	Average Line Current / A	⚡	0.2	30	4.922	NORMAL	2019-04-23 16:24:01
1	AcuVim II USB	AcuVimIISUSB	Voltage Flatline	Average Line-to-Neutral Voltage / V	⚡	0.5	150	119.853	NORMAL	2019-04-23 16:24:01
2	AcuVim II TCP	AcuVimIITCP	Current Flatline	Average Line Current / A	▲	0.2	30	0.000	UNDERFLOW	2019-04-23 16:15:04
1	AcuVim II USB	AcuVimIISUSB	Voltage Flatline	Average Line-to-Neutral Voltage / V	▲	0.5	150	0.000	UNDERFLOW	2019-04-23 16:15:01
2	AcuVim II TCP	AcuVimIITCP	Current Flatline	Average Line Current / A	⚡	0.2	30	5.051	NORMAL	2019-04-23 15:56:01
2	AcuVim II TCP	AcuVimIITCP	Current Flatline	Average Line Current / A	▲	0.2	30	0.000	UNDERFLOW	2019-04-23 15:54:02
2	AcuVim II TCP	AcuVimIITCP	Current Flatline	Average Line Current / A	⚡	0.2	30	5.099	NORMAL	2019-04-23 15:53:03
1	AcuVim II USB	AcuVimIISUSB	Voltage Flatline	Average Line-to-Neutral Voltage / V	⚡	0.5	150	119.799	NORMAL	2019-04-23 15:53:02

Chapter 6: AcuLink 810 User interface

6.7.2 Event Logs

Users can check the historical data of the system event by clicking on 'Event Log' under 'LOG' menu.

Event logs can be filtered by selecting the start time, end time and level.

Users can also clear all the event logs by clicking on 'Clear Logs'.

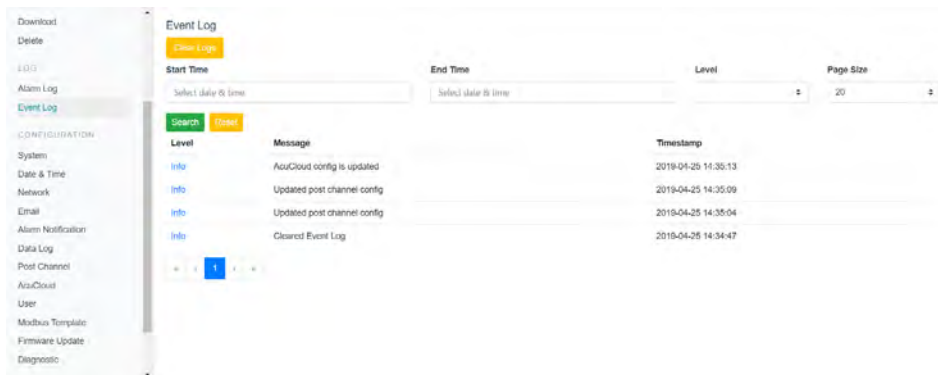

6.8 System Settings

The system settings page can be found on the left navigation panel under the 'CONFIGURATION' menu. This page gives users a summary of the AcuLink 810's hardware version, serial number, the current firmware version and the date it was updated.

Users can restart the server, which is a soft reboot of the AcuLink 810 device.

In the System Information page there are also options to provide a Name, Description, and location for the AcuLink 810 device. Once the user has filled in the settings correctly click on 'Save'.

In the System Status section of the page, users are provided with an overview of the CPU, RAM, and disk usage.

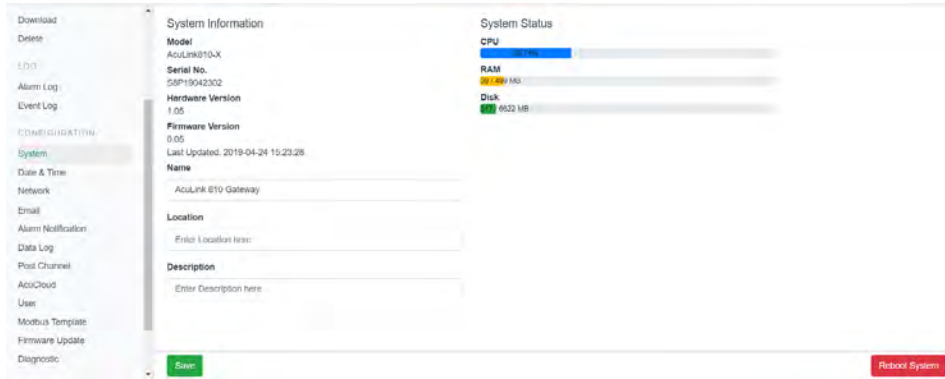

6.9 Date & Time

Users can configure the time and date for the AcuLink 810 from the 'Date & Time' page in the left navigation panel under the 'CONFIGURATION' menu.

- **NTP Enabled:** The AcuLink supports Network Time Protocol where the time can be synchronized with a time server.
- **Device Clock:** Users can enter in the time and date manually in the device clock setting. Once the time and date is chosen the user must click on 'Update Time'.
- **Time Sync:** Users can force the time to update on the AcuLink 810 by selecting the 'Sync' button.
- **NTP Time Servers:** By default the gateway uses '0.u.pool.ntp.org' time server. Users can remove and add their own time servers as needed.
- **NTP Server 1;2;3:** Users can enter up to 3 NTP servers in the "NTP Server 1", "NTP Server 2" and "NTP Server 3" fields.

Examples of North American NTP servers are:

0.us.pool.ntp.org

1.us.pool.ntp.org

2.us.pool.ntp.org

3.us.pool.ntp.org

For more NTP servers based on region, visit the following site:

<http://www.pool.ntp.org/en/>

Chapter 6: AcuLink 810 User interface

- **Time Zone:** Users can select the timezone where the gateway is installed.

The screenshot displays the 'Date & Time' configuration page in the AcuLink 810 web interface. On the left is a sidebar menu with categories like 'Download', 'Delete', 'LOG', 'CONFIGURATION', and 'System'. The 'Date & Time' option is selected. The main panel shows 'NTP Enable' as a toggle switch set to 'Enabled'. Below it, the 'Device Clock' is displayed as 'Thu, Apr 25, 2019 2:41 PM' with 'Update Time' and 'Sync' buttons. Three 'NTP Server' fields are present: 'NTP Server 1' contains '0.us.pool.ntp.org', 'NTP Server 2' contains 'Enter NTP Server 2 here', and 'NTP Server 3' contains 'Enter NTP Server 3 here'. A 'Time Zone' dropdown menu is set to 'America/Toronto'. A green 'Save' button is located at the bottom of the configuration area.

6.10 Network Settings

The AcuLink 810 supports both Ethernet and WIFI communication. There are two Ethernet ports that can be used. The network settings can be found under the 'CONFIGURATIONS' menu on the left panel of the gateways web interface.

The DNS settings for the AcuLink are displayed. By default the DNS settings are:

- **DNS 1:** 8.8.8.8
- **DNS 2:** 8.8.4.4

6.10.1 WIFI

Users can configure the WIFI settings by selecting the 'WIFI' tab on the Network Configurations page.

Wi-Fi Enabled: Users can enable or disable the WIFI on the AcuLink 810

Wi-Fi Mode: There are two WiFi Modes:

1. Access Point Mode: Where the AcuLink 810 acts as a wireless bridge allowing other wireless devices to connect to it.

- **SSID:** Users can create an SSID for the gateway, which will be used when other devices connect.
- **Network Key:** Users can create a network key
- **IP:** Users can also enter in an IP address that will be used to access the meter while in Access Point Mode.

NOTE: The default Network Key is *accuenergy*, and the default IP address is *192.168.100.1*

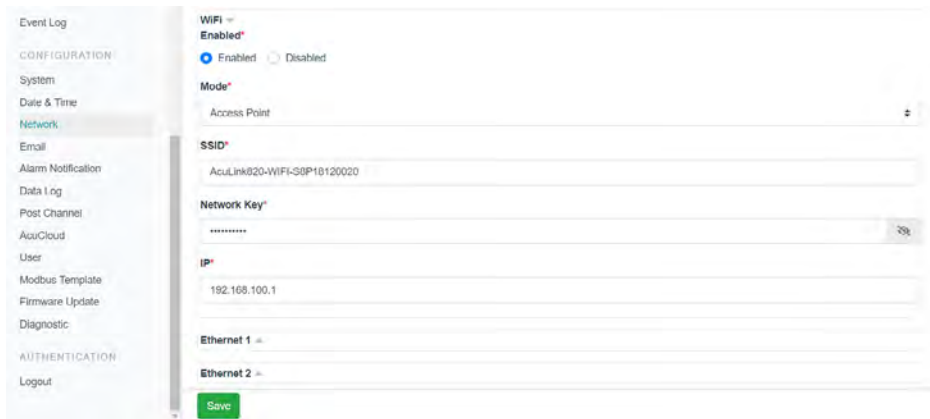

2. Station Mode: Where the AcuLink 810 joins an existing WIFI network.

- **SSID:** Users can select from the list of wireless networks in range of the AcuLink 810.
- **Network Key:** Network key of the selected wireless network must be entered in this setting.
- **DHCP:** Can be set to 'Manual' or 'Auto', where if 'Manual' is selected the Subnet Mask and Gateway will also need to be provided. If 'Auto' is selected the AcuLink will have an IP address automatically assigned. With this selection the Subnet Mask, Gateway and will also be automatically assigned.
- **Interface Status:** Will notify the user whether the AcuLink is connected or disconnected to the WIFI network.

Chapter 6: AcuLink 810 User interface

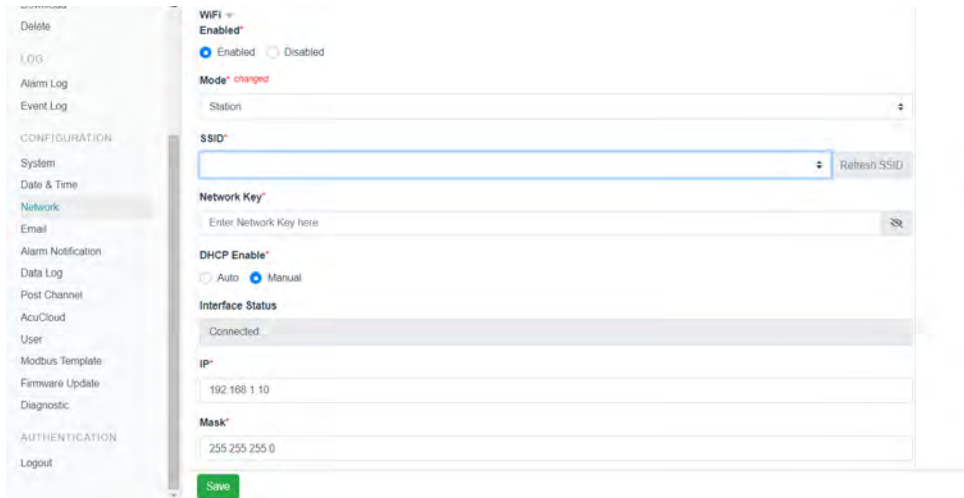

By default the WIFI mode is set for Access Point Mode, where the AcuLink 810 acts as a wireless bridge allowing other wireless devices to connect.

6.10.2 Ethernet 1

The Ethernet 1 settings can be configured by selecting the 'Ethernet 1' tab on the Network Configurations page.

- **Interface Status:** Tells users whether there is an Ethernet cable connected or disconnected to the Ethernet 1 port.
- **DHCP:** Select 'Manual' to manually configure the IP address for Ethernet 1. If set to 'Manual', users will also need to set the Subnet Mask and Gateway. Select 'Auto' to have the AcuLink 810 assigned an IP address automatically. With this selection the Subnet Mask, Gateway and will also be automatically assigned.
- **IP:** If the DHCP is configured to Manual, the IP address can be configured.
- **Subnet:** If the DHCP is configured to Manual, the Subnet Mask can be configured.
- **Gateway:** If the DHCP is configured to Manual, the Gateway can be configured.

By default Ethernet 1 has the following settings:

- DHCP: Manual
- IP: 192.168.8.101
- Subnet: 255.255.255.0
- Gateway: 192.168.8.1

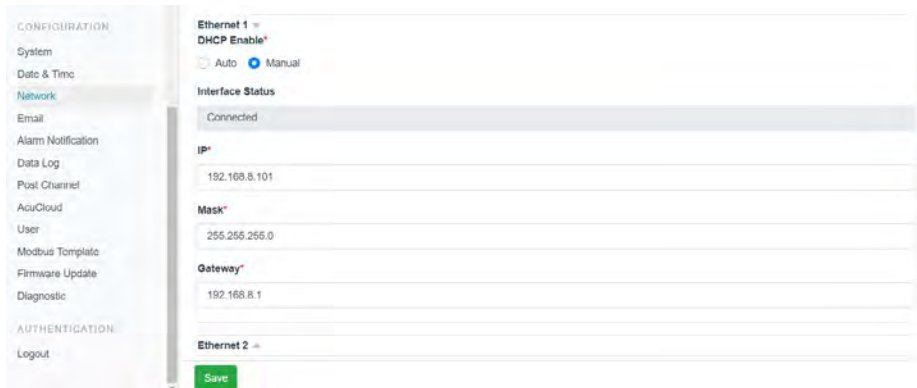

6.10.3 Ethernet 2

Ethernet 2 by default has the DHCP settings configured to 'Auto'. This means that when connected to an internet source such as a router/switch, the network will assign an IP address to it. Once the IP is assigned, users can discover the IP address by accessing the Network Configurations page.

Users can also change the DHCP to 'Manual' for Ethernet 2 and connect to the network manually.

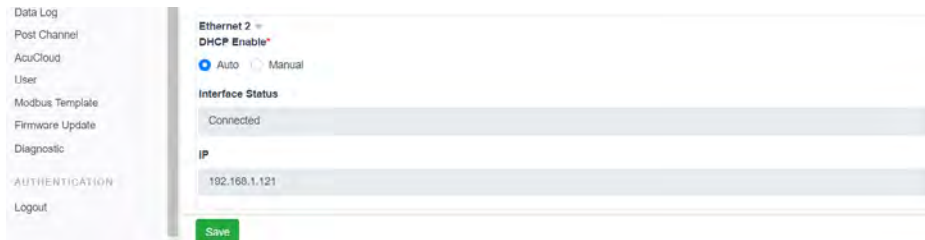

6.11 Email (SMTP)

Users can send emails for alarm triggering. To do this on the AcuLink 810 users must configure the SMTP server and credentials.

To configure the Email setting, select 'Email' under the 'Configuration' menu on the left panel of the interface.

The user must first configure their SMTP server settings and details in order for the gateway to send the emails.

- **Email Server:** Enter the SMTP Server for the email account.
- **Email Port:** Enter the outgoing port number the SMTP uses to send emails.
- **TLS/SSL:** Select Auto/On/Off for the email's server. Please select Auto if the security setting of the server is unknown.
- **Sender Name:** Enter a sender name for the email
- **From Email Address:** Enter the email address that will be in the from field of the email
- **Username:** Enter the email address for where the emails will be coming from
- **Password:** Enter the password for the email address in Username

Click 'Save' once all the settings are entered in correctly.

The screenshot shows the 'Email' configuration page in the AcuLink 810 user interface. The left sidebar contains a navigation menu with categories like 'Download', 'LOG', 'CONFIGURATION', and 'AUTHENTICATION'. The 'Email' option is selected under 'CONFIGURATION'. The main content area contains the following fields:

- Email Server:** ssl.digitalhosting.ca
- Email Port:** 587
- TLS/SSL:** Radio buttons for Auto (selected), On, and Off.
- Sender Name:** Test
- From Email Address:** test@accuenergy.com
- Username:** test@accuenergy.com
- Password:** A masked password field with a toggle for visibility.

A green 'Save' button is located at the bottom of the form.

6.12 Alarm Notification

Select 'Alarm Notification' under 'CONFIGURATION' menu to set the email recipients that will receive the emails for alarms.

To enable the alarm notification, select 'Enabled'. With the alarm notification enabled users will be notified via email when an alarm is over/under the alarm condition. The AcuLink 810 supports a maximum of 3 recipients, once email address for each recipient is entered and click on 'Save'. Once an recipient has been added, users can click on 'Test Email' button to check if a test email is received.

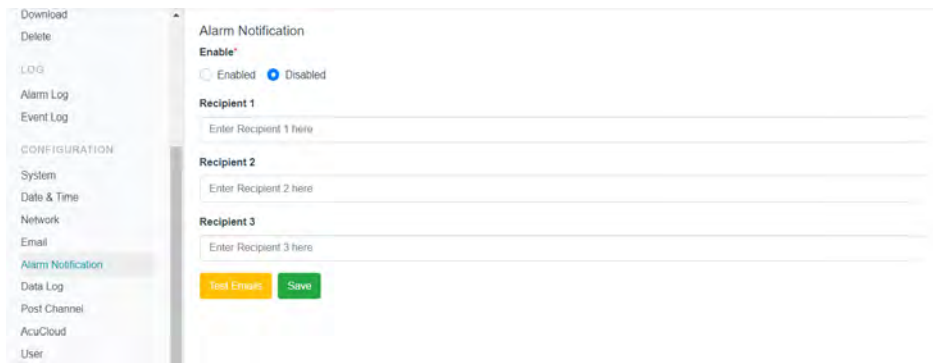

6.13 Post Channels

The AcuLink 810 supports 3 HTTP/FTP channels.

To configure the HTTP/FTP data forward from the web interface click on 'Post Channel' under the 'CONFIGURATION' menu on the left panel of the interface.

To configure the post channels select the corresponding post channel tab.

6.13.1 HTTP Post Method

The HTTP post method allows the user to post meter data to an HTTP/HTTPS server.

Post Channel Enable: Select Enabled to enable the post channel data forward

Post Method: Choose from either HTTP/HTTPS in the drop down menu

Post Name Fixed: Select Yes or No to enable a fixed post name, if yes selected enter in the post name.

Chapter 6: AcuLink 810 User interface

HTTP/HTTPS URL: Select HTTP or HTTPS option from the drop down menu before entering in the URL. Next enter in the URL of the server.

HTTP/HTTPS Port: Enter the correct port for the HTTP server.

HTTP/HTTPS Meter ID: Enter in the meter ID

Once the settings are entered in correctly click on 'Save'. After the settings are saved, users can use the 'Test Post Channel' button to test whether the AcuLink 810 can successfully reach the HTTP server.

NOTE: If users receive a fail message, please verify the server URL, port number and double check the network connectivity.

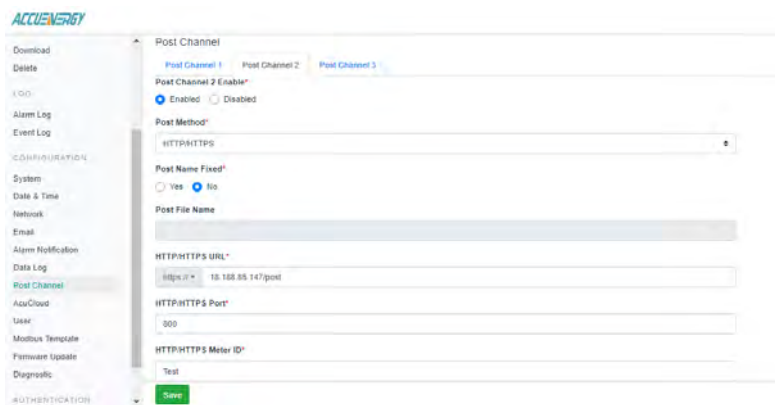

6.13.2 FTP Post Method

The FTP post method allows the user to post meter data to an FTP server.

Post Channel Enable: Select Enabled to enable the post channel data forward

Post Method: Select FTP protocol

FTP URL: Enter in the FTP URL

FTP Port: Enter the FTP port number

FTP Username: Enter the username to access the FTP server

FTP Password: Enter the password to access the FTP server

Once all settings are entered in correctly, click on 'Save'. Users can use the 'Test Post Channel' button to determine whether the 810 can reach the FTP server.

NOTE: If users receive a fail message, please verify the server URL, port number, username, password and double check the network connectivity.

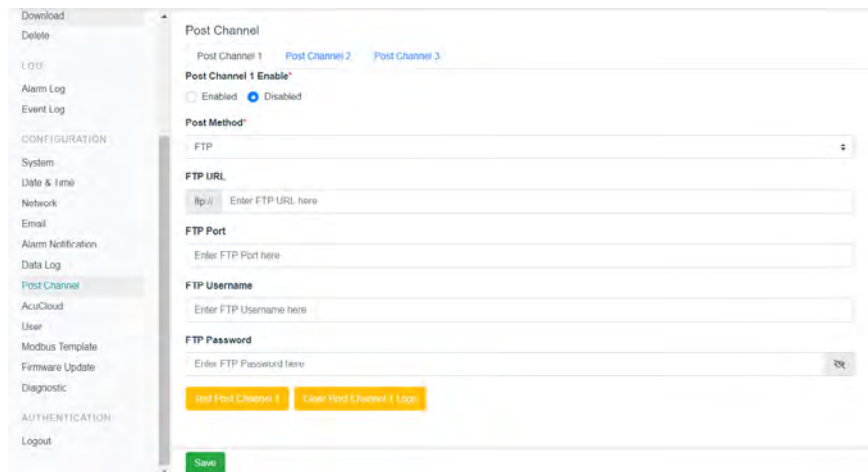

6.14 Data Logging

The AcuLink 810 supports data logging to its internal memory, which has 8GB of memory. When the memory is full the oldest data logs will be overwritten. To configure the AcuLink 810 to log the meter data click on 'Data Log' under the 'CONFIGURATION' menu on the left navigation panel.

AcuLink 810 supports at most 3 data loggers, the data log for each logger can be pushed to the post channel or saved in its internal memory.

- **Data Log Enable:** Select 'Enabled' to enable the data log
- **Post Channel:** Select the Post Channel from the drop down list:
 - None: AcuLink 810 will log and store the data on its memory
 - Post Channel 1/2/3: AcuLink 810 will log and push the data to the configured post channel. Users will not be able to select the post channel if it is disabled.

NOTE: For more information on configuring the Upload Protocol refer to the 'Post Channels' section of the user manual.

Chapter 6: AcuLink 810 User interface

- **Timestamp Format:** Select the format of the timestamp for the data that is logged. The format for the timestamp can be based on the Local Time, UTC Seconds or based on ISO8601 Format.
- **Log File Name Format:** Select the format of the log file name for the data that is logged. The format for the log file name can be based on UTC Timestamp or Time interval Format.

The screenshot shows the 'Data Log' configuration page in the AcuLink 810 user interface. On the left is a navigation menu with options: CONFIGURATION, System, Date & Time, Network, Email, Alarm Notification, Data Log (highlighted), Post Channel, AcuCloud, User, Modbus Template, Firmware Update, and Diagnostic. The main content area is titled 'Log Interval' and contains the following settings:

- Log Interval:** A dropdown menu set to '1 minute'.
- Log File Length:** A dropdown menu set to '1 minute'.
- Log File Name Prefix:** A text input field containing 'logger1'.
- Devices:** A section with several checkboxes for selecting devices to log data for:
 - DI Counters
 - AcuDC 243 RTU #AcuDC243RTU
 - AcuRev 1312 RTU #AcuRev1312RTU
 - AcuRev 2020 RTU #AcuRev2020RTU
 - AcuVim II USB #AcuVimIIUSB
 - AcuRev 2020 TCP #AcuRev2020TCP
 - AcuVim L RTU #AcuVimLRTU
 - AcuVim L V3 TCP #AcuVimLV3TCP

A green 'Save' button is located at the bottom right of the configuration area.

- **Log Interval:** Select how frequently the module will log data to the file from the drop down list. The logging interval can be from 1 minute to 1 month.
- **Log File length:** Select the length of the log file, it can be from 1 minute to 1 month.

NOTE: The log interval must be less than or equal to the log file length.

- **Log File Name Prefix:** Provide a name for the log file which will be appended to the beginning of the log file. By default "logger1" will be appended to the beginning of the log file.
- Select the device(s) to log the data for.

When all of the settings are entered in correctly, click on 'Save'. All the data logs can be downloaded from 'Download' under 'DATA MANAGEMENT' menu.

NOTE: For more information on data log downloading and deleting, please refer to the 'Data Management' section of the user manual.

6.15 AcuCloud

Users can upload meter data to Accuenergy's free cloud based software called AcuCloud. AcuCloud is a cloud-based facility metering platform that provides users access to data from Accuenergy's power meters, and is free for all Accuenergy meters.

To configure the AcuLink 810 to post data to AcuCloud, click on 'AcuCloud' from left navigation panel under the 'CONFIGURATION' menu.

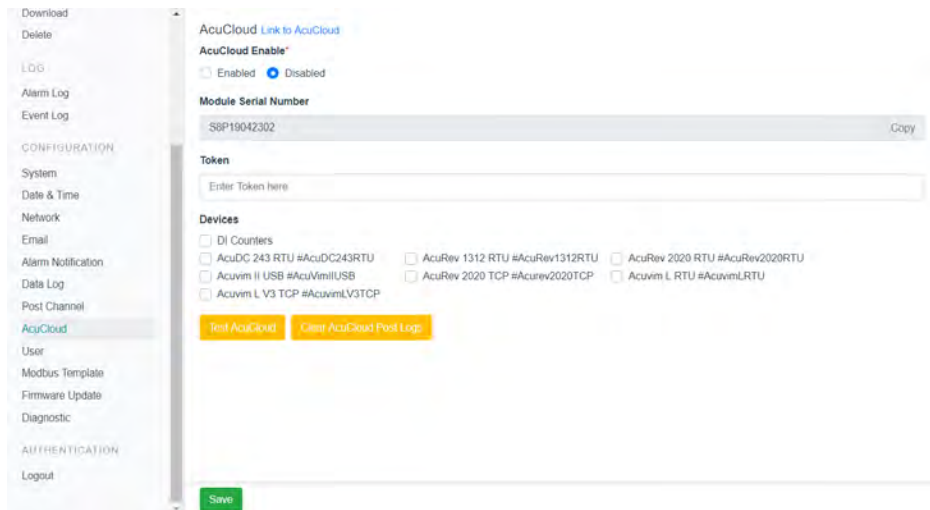

Users will need an AcuCloud account in order to add the AcuLink 810 as a device. To create your AcuCloud account contact Accuenergy Technical Support.

If you already have an AcuCloud account, the following steps can be used to add the gateway to AcuCloud.

Chapter 6: AcuLink 810 User interface

- Login to your AcuCloud account with sufficient access to add new devices.

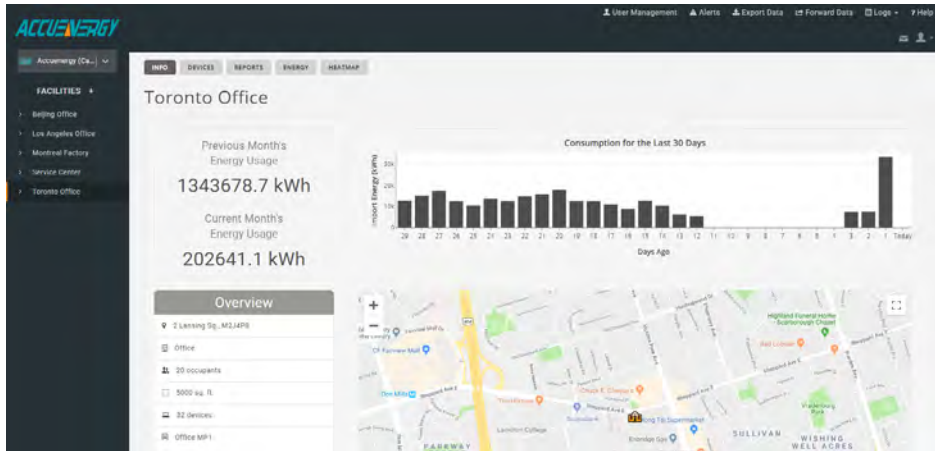

Adding a new device to the Device List can be done from the Facilities page

- Click on the Devices tab
- Click on the + NEW DEVICE button.



The following details need to be entered:

- Select the name of the Facility in which the device will belong to from the Facility drop down list.
- Select the AcuLink 810 from the Model drop down list.
- Select "This is a gateway Device"
- Provide a name for the device under Device Name.
- The Serial Number of the AcuLink 810 in the serial number field.

NOTE: The serial number can be found and copied on the AcuCloud configuration page of AcuLink 810 web interface.

- Provide a description for the location of the device under Location.
- Click SUBMIT.

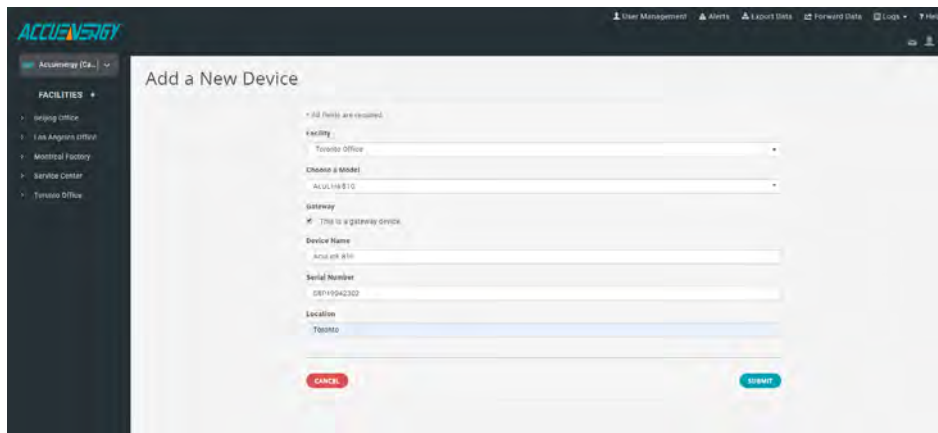

Once the gateway has been successfully created, a token will be returned on the ensuing page. The user will need to copy the token that is provided as it will be used in the next step to configure the gateway to send its data to AcuCloud.

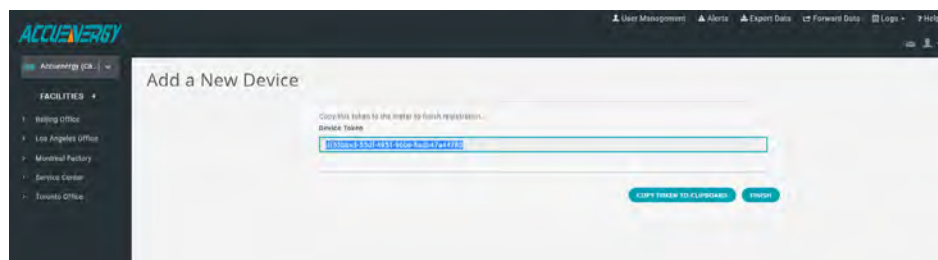

- Go back the AcuLink 810 web interface and paste the token that was generated into the AcuCloud Token field.

Chapter 6: AcuLink 810 User interface

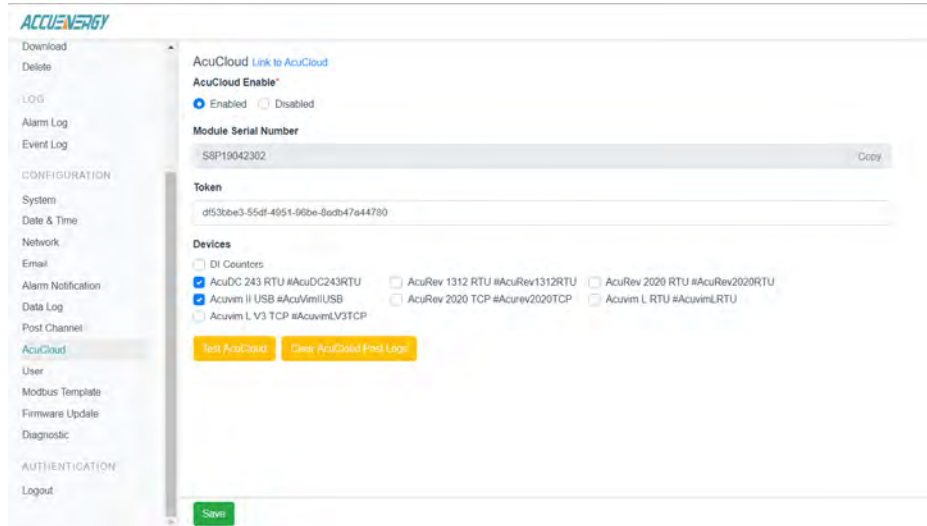

- Select the devices that need to be connected to Acuccloud.
- Click Save
- Then click on 'Test Connection' to see if the AcuLink can reach the Acuccloud server.

NOTE: If the test connection fails, please check the network settings of the AcuLink 810 and if the token is entered correctly.

The AcuLink 810 gateway is now successfully configured to report to the AcuCloud EMS software. Check to see if AcuCloud is receiving data from the gateway by going to the Devices page in AcuCloud and observing whether the name of the selected devices from the gateway appear in AcuCloud with a Last Received Data timestamp.

If the gateway is offline or stops posting to the cloud, it will be backed up to the last 3000 posts. Once the meter reestablishes a connection to the cloud it will post the files to AcuCloud. Users can remove or clear the back up posts at anytime by clicking on the 'Clear AcuCloud Post Logs' button.

6.16 Data Management

You can manage the data logs directly from the user interface of the AcuLink 810. This page allows the user to download or delete data from their Modbus devices.

6.16.1 Download Data

To download the Data Logs select the 'Download' tab under 'DATA MANAGEMENT' menu.

- **Select Device:** Select the device you wish to read the data from.
- **From/To Date:** Select the date and time frame to read the data log.

NOTE: Data Logs will only be recorded for the devices that have been selected in logger 1,2,3 or AcuCloud.

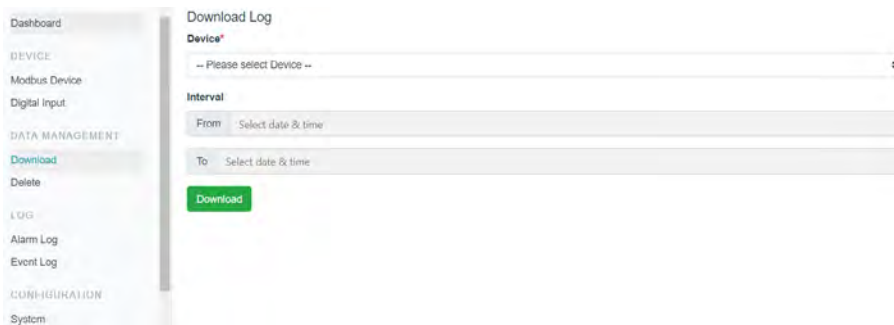

Click on 'Download' once all information is entered in correctly. The data will be downloaded as a .csv file to your computer directly.

NOTE: Depending on the amount of data stored this may take several minutes to complete the data download.

Delete Data

To delete the Data Logs select the 'Delete' tab under 'DATA MANAGEMENT' menu.

Select Device: Choose the device you want to delete data for.

Once all the settings are entered in correctly, click on 'Delete Data Log'. All the data related to the selected device will be deleted.

NOTE: Once data is deleted from the AcuLink 810 it cannot be undone.

Chapter 6: AcuLink 810 User interface

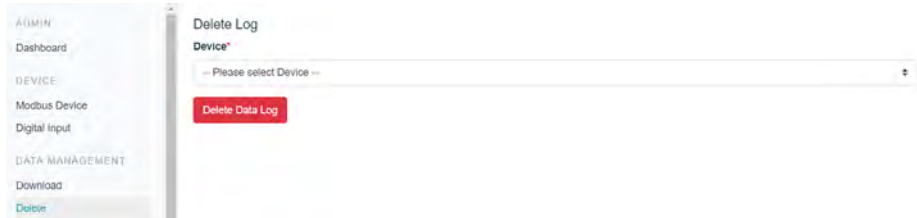

6.16.2 Users Password

When users are logged in as an Admin they can change the password for both Admin and Viewer access levels. Once the new password is entered click on 'Save'.



6.16.3 Firmware Update

The firmware of the AcuLink 810 can be updated from the 'Firmware' page under the 'CONFIGURATIONS' menu. This page lists the current firmware of the gateway.

The firmware update can be updated manually or remotely using the server.



Manual Firmware Update

To manually update the firmware of the AcuLink 810, click browse and upload the firmware file. The file should have a **.aup** file extension.

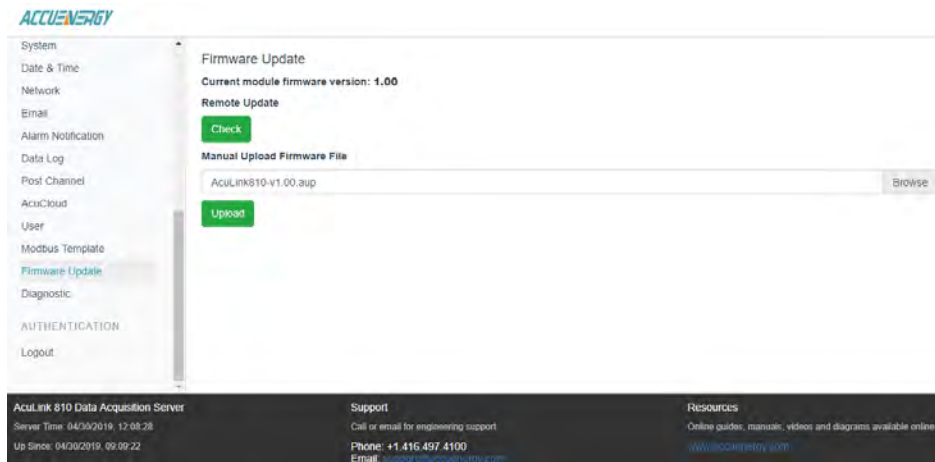

Click on 'Upload' to begin uploading the firmware.

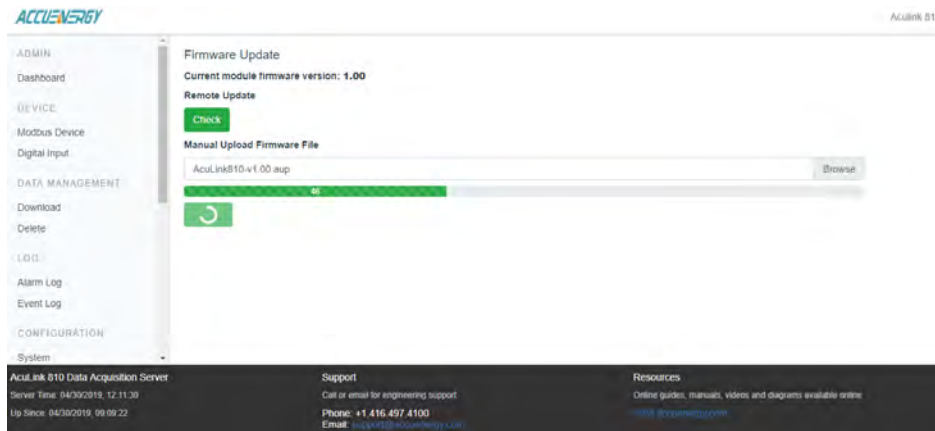

Chapter 6: AcuLink 810 User interface

Once the firmware is uploaded, click on 'Start' to begin the updating process.

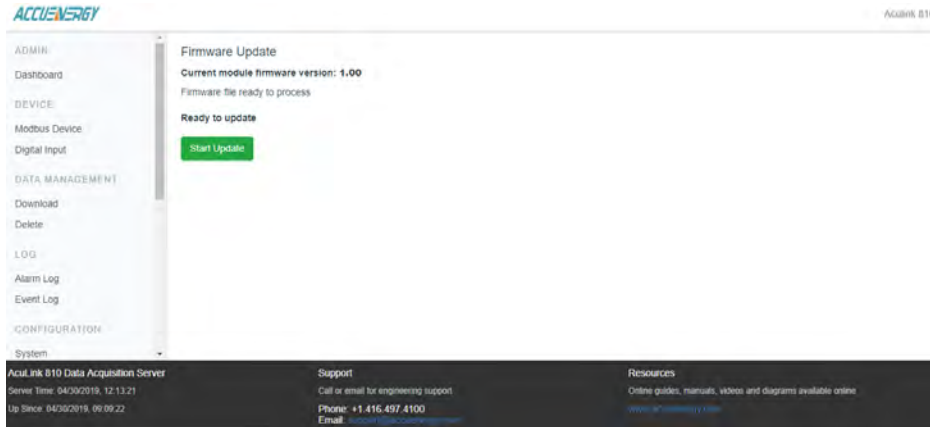

Once the firmware update is complete, the AcuLink 810 will restart.



Remote Firmware Update

The firmware of the AcuLink 810 can be updated using the remote firmware option. This will allow users to check for the latest firmware updates. To use the remote firmware update click on 'Check' which will verify if there is an update available or whether the gateway already has the latest firmware.

NOTE: When updating the AcuLink 810 firmware remotely ensure that you have sufficient connection to the internet.



Click on 'Update' to begin downloading the firmware from the remote firmware server.

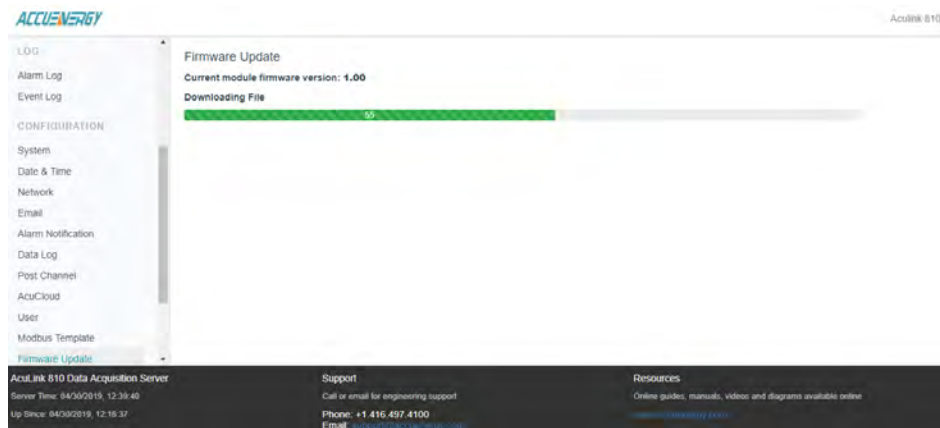

Chapter 6: AcuLink 810 User interface

Once the download is complete the firmware update will begin.

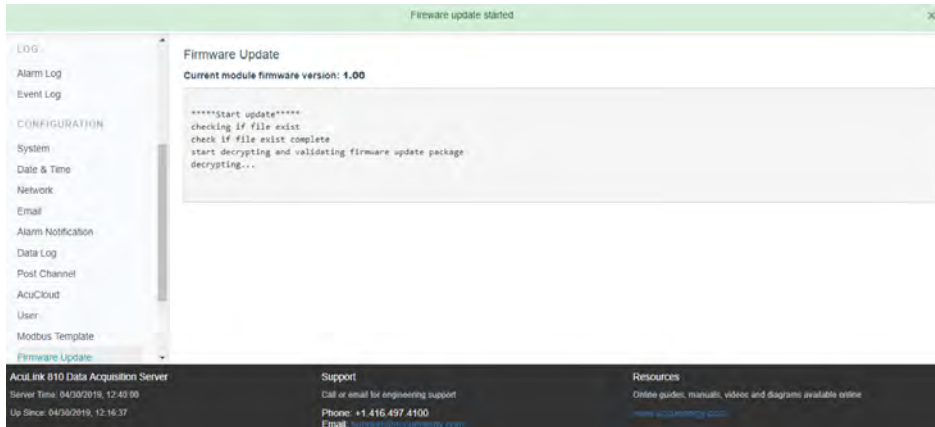

After the firmware update is complete, the AcuLink 810 will restart.

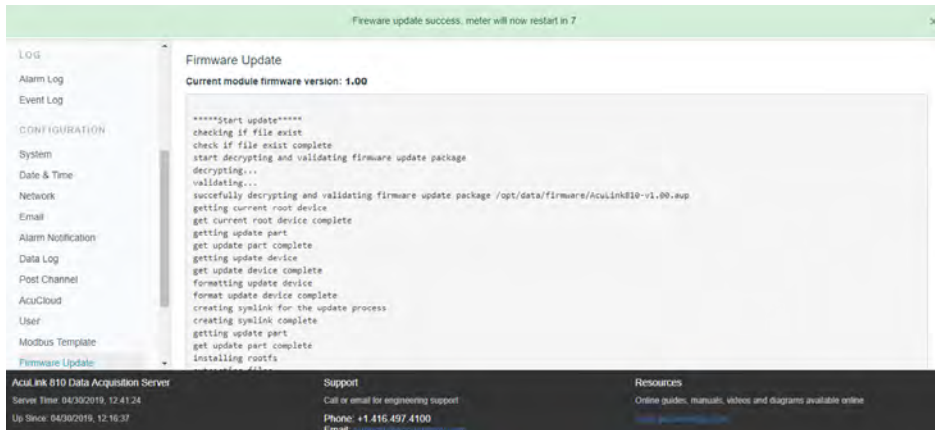

6.17 Network Diagnostics

The AcuLink 810 has a network diagnostics page which can be used to monitor the network status of the gateway.

In the Network Status tab users can see the Ethernet Network status, the routing table, DNS, network stat, and the WIFI status.

NOTE: In order to see the WIFI network status the AcuLink 810 must be configured for Station Mode.

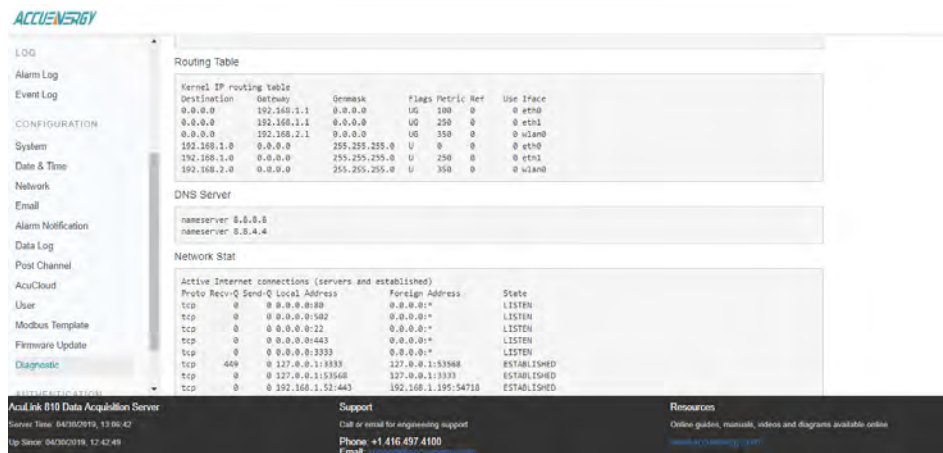
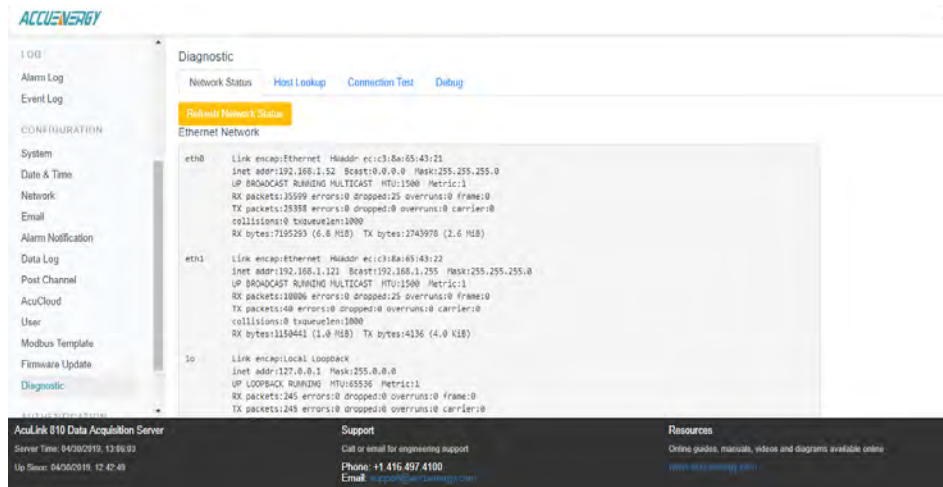

Chapter 6: AcuLink 810 User interface

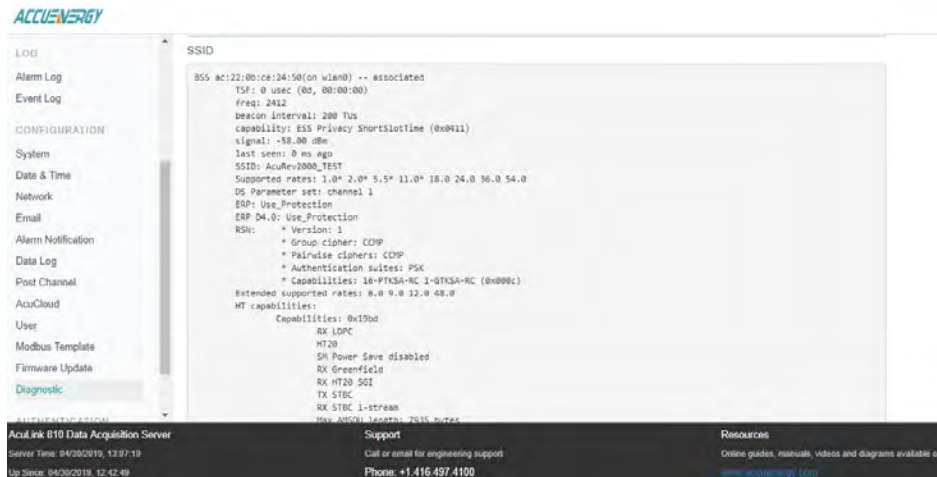

In the 'Host Look Up' tab, users can use the ping function to test whether the AcuLink can communicate over the network it is connected to.

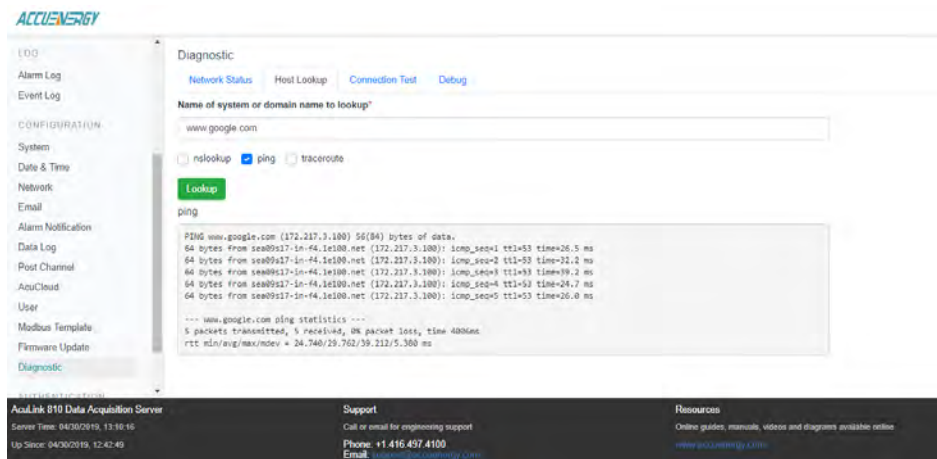

Under the 'Connection Test' tab user can test the local network that the AcuLink is connected to. The test result will show SUCCESS and PASS if there is no issues found, and will show FAIL if there are network issues.

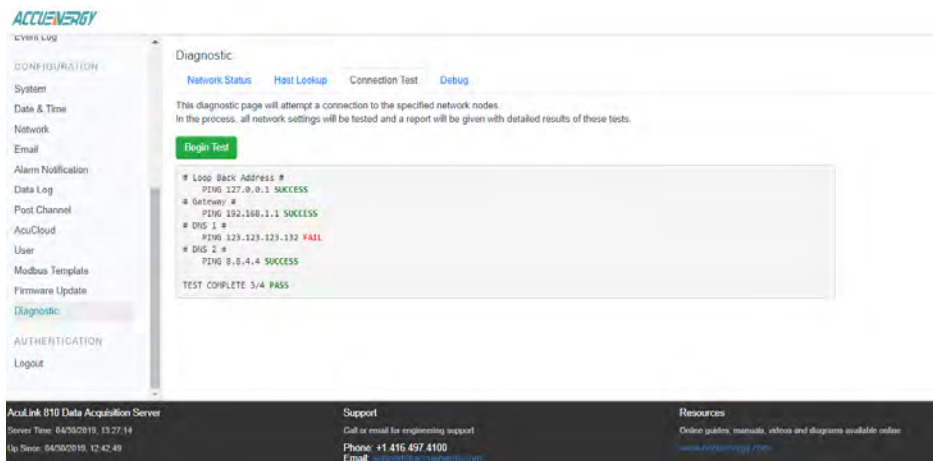
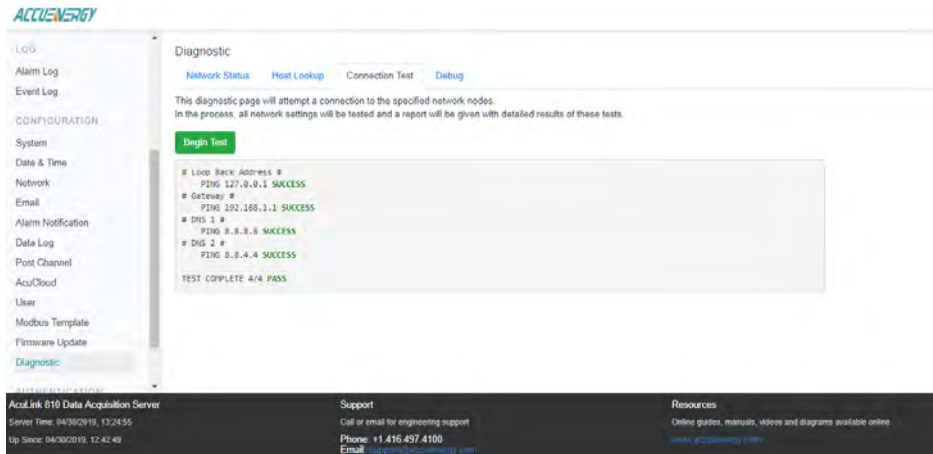

On the 'Debug' tab, users can turn on or turn off SSH. From the debug page users can also download the AcuLink 810's diagnostic file.

The debug diagnostic options are recommended to be all 'OFF' as this feature is mainly used for troubleshooting and can affect the performance of the gateway if turned on.

Chapter 6: AcuLink 810 User interface

The AcuLink 810's diagnostic file can be downloaded by the user from the Debug page. If users are experiencing any issues with the gateway, the diagnostic file can be sent to Accuenergy Technical Support for further analysis.

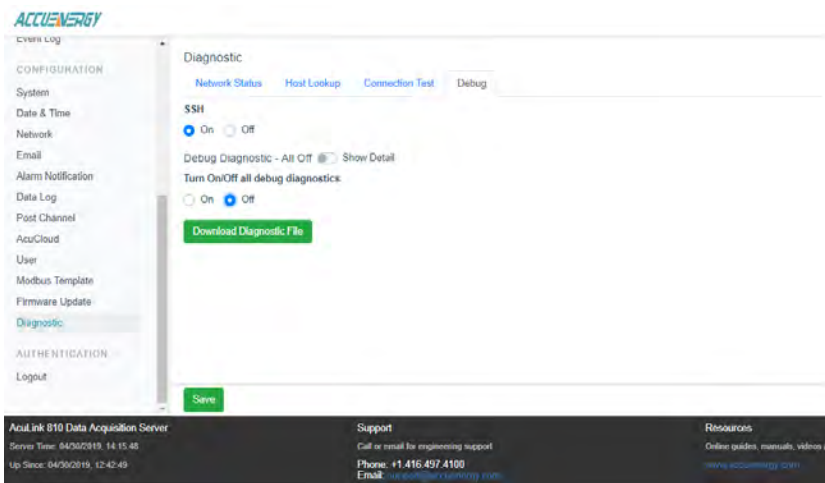

7. LED Description

There are a total of 13 LEDs on the AcuLink 810 data acquisition server and each represent different functions pertaining to the unit.

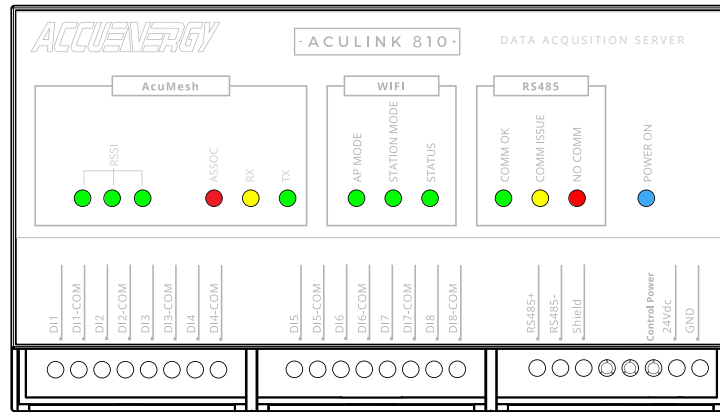

With the exception of the blue power LED, the remaining LEDs can be divided into three groups:

7.1 AcuMesh LEDs

The AcuMesh has a total of six LEDs which are related to the AcuMesh status.

- **RSSI** - There are three RSSI LEDs which indicate the signal strength of the incoming signal.
- **ASSOC** - Indicates that the transceiver is powered on or it is communicating. The Red LED is 'ON' when powered, and briefly 'ON' or flashing during RF transmission.
- **RX** - Indicates that the transceiver is receiving data.
- **TX** - Indicates that the transceiver is transmitting data.

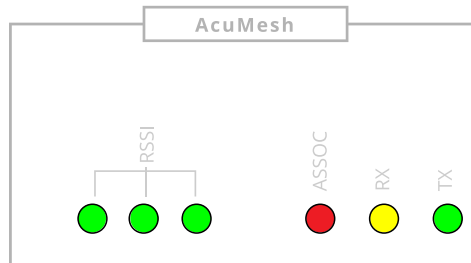

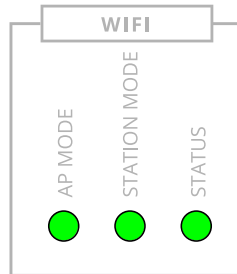

7.2 WiFi LEDs

The WiFi has a total of 3 LEDs which are related to the WiFi status.

- **AP MODE** - when 'ON' Indicates that the WiFi is working in Access Point Mode
- **STATION MODE** - when 'ON' indicates that the WiFi is working in Station Mode
- **STATUS** - When 'ON' indicates that the WiFi is working and functioning properly.

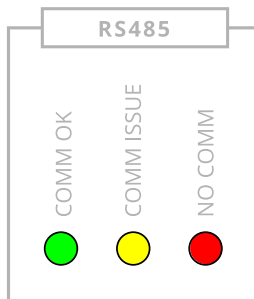

7.3 RS485 LEDs

The RS485 has a total of 3 LEDs which are related to the RS485 status.

- **COMM OK** - When 'ON' indicates that all RS485 and USB devices in RS485 network are online and is represented by a green LED.
- **COMM ISSUE** - When 'ON' indicates that some of the devices in the RS485 network are offline and is represented by a yellow LED
- **NO COMM** - When 'ON' indicates that all RS485 devices in the RS485 network are offline and is represented by a red LED

8. Reset Button

On the AcuLink 810 unit there is a reset button located on the back of the unit where the Ethernet and USB ports are. The reset button resets the AcuLink 810 back to default meaning that all devices, data logs, alarm/event log, and device templates will be deleted. The only Device Template that will remain after the reset is the Modbus Gateway Function, however all other Modbus templates will be removed.

After the reset all network communications will be restored back to default meaning the AcuLink will have the following network settings after the reset:

- **WiFi Mode** - Access Point (AP) mode
- **Ethernet 1** - 192.168.8.101
- **Ethernet 2** - DHCP enabled

To successfully perform a reset on the AcuLink 810 gateway press and hold the reset button for 10 seconds until all LED lights on the unit are flashing. The reset will be complete when the LED lights stop flashing.

