

AccuMASTERTM Pro

10" DIGITAL TORPEDO LEVEL Model 7210

User's Guide

**Accurate,
Easy to Read
and Rugged**

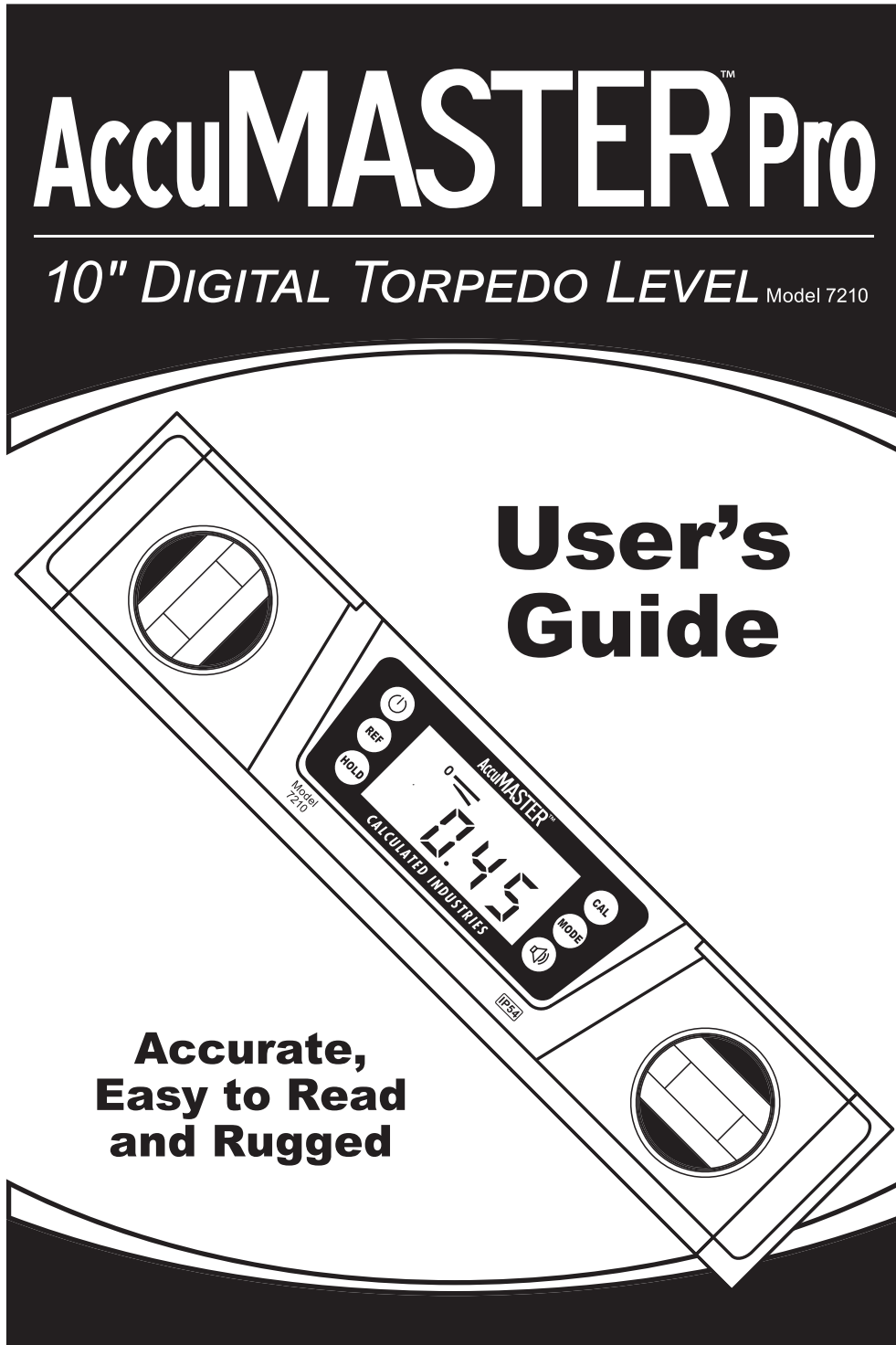

AccuMASTER 10" Digital Torpedo Level User's Guide

Using Your AccuMASTER Digital 10" Torpedo Level

Level and Plumb Measurements

Level (horizontal) and Plumb (vertical) measurements can be made with both the LED display and the bubble vials. The LED display will show the actual angle of the surface with a bar showing whether the surface should be moved "in" or "out". A beep will sound at 0° and 90°, if the sound function is turned on.

To Use the Level for Angle Measurements

Pitch - The level can be used to measure pitch. For example, the pitch of a roof, measured in inches of rise per foot of run. Push the Mode button to change the display to Pitch mode (IN/FT, mm/m).

Slope - When the display is in the slope mode, it will measure the angle or slope of the work surface in percent, with exact level at 0.0%. If the sound is turned on, the level will beep at 0.0% and 100%. Push the Mode button to change the display to Slope mode (%).

True Level/Relative Angle Measurements (Alternate Zero Button)

True Level - Place the level on a flat smooth surface. The display indicates the absolute angle between "true level" and the working surface. The arrows indicate the orientation of the working surface: either above or below true level.

Relative Angle Measurements - Use this function to compare the angle between two work surfaces. Press the REF button and the "S" icon will appear in the upper middle of the display. Move the level to the second work surface to determine the difference in the two surfaces' angles. Press the REF button again to return to True Level mode.

AccuMASTER Digital 10" Torpedo Level Specifications

Power Supply	2 AAA 1.5 volt batteries
Estimated Battery Life	40 hours of continuous use
Operating Temperature Range	32° – 104° F (0° – 40° C)
Storage Temperature	14° – 122° F (-10° – 50° C)
Dimensions	10" x 2.25" x 1.1" (254 x 27 x 59 mm)
Weight	11.6 oz. (330g) with batteries
Display	LED
IP Protection Class	IP54 certified – Water and dust resistant
Measuring Range	4 x 90°
Resolution	+/-0.05°
Accuracy	+/-0.2°
Digital Display of Angle	° (Degree), % (Slope), IN/FT, mm/m (Pitch)
Magnet	Built in V-groove aluminum base

Calibration

Note: The device is calibrated in the factory for maximum accuracy. Users can re-calibrate if necessary. It is recommended when you first receive your AccuMASTER Level, you should follow these steps to calibrate it for your local area.

1. Power off the level.

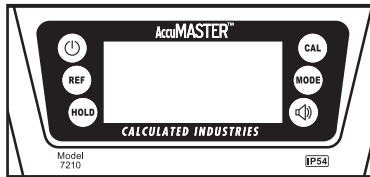

2. In the shutdown state, press and hold the CAL button, then press and hold the On/Off button until "CAL" appears briefly in the display. Release once displayed.

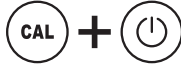

3. Place the level on a flat and smooth surface. Hold the level still for 10 seconds until the display digits stop changing, then press the CAL button, "CAL1" appears briefly in the display.

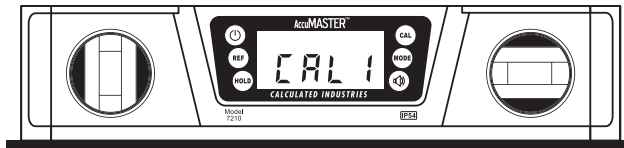

4. Rotate the level 180°, wait for 10 seconds until the display digits stop changing, then press the CAL button until "CAL2" displays. Once "CAL2" disappears, it indicates the user calibration is complete. The display will show the current angle.

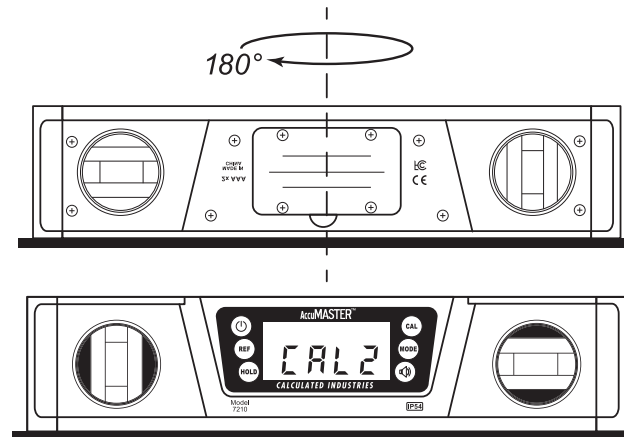

Device

The **AccuMASTER 10" Digital Torpedo Level** will help you on the job in all kinds of working environments. It is dust and water resistant and operates in challenging working conditions – it will give you accurate measurements in any weather*, from 32° F – 104° F. It has a bright easy-to-read LED display and you can set it to give you an audio alert when you find plumb and level. It operates in two modes – True Level and Alternate Zero/Relative Angle.

- ❶ Angle Measurement
- ❷ Low Battery Icon
- ❸ Level Measurement Icon
- ❹ Sound Icon
- ❺ Hold Icon
- ❻ Unit Icon
- ❼ Alternate Zero Icon

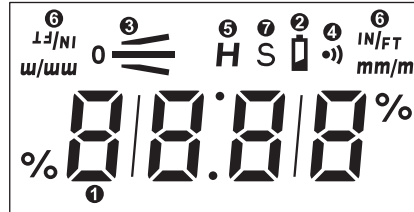

- Ⓚ **On/Off button** – Press and hold for 1 second to turn on. This feature prevents the device from accidental activation. It will turn off if not used for 3 minutes, conserving battery life.
 - Ⓡ **REF button** – If the surface the device is on is not level, the unit will display a value on the screen. Press the REF button to set current angle to be zero, this will enter the device into Alternate Zero mode. The “S” icon will show on the display. Press the button again to quit the function.
 - ⓗ **HOLD button** – Press the button to “Hold” the display. An “H” displays on the screen. Press again to “unhold” the value on the screen.
 - Ⓒ **CAL button** – Use in conjunction with the On/Off button to re-calibrate the level. See Calibration for additional details.
 - Ⓜ **MODE button** – Press the button to switch between units of measure ° (Degree), % (Slope), IN/FT, mm/m (Pitch).
 - 🔊 **Sound button** – Press to turn the sound feature on. The sound icon will display in the upper right of the screen. Press again to turn the sound off.
- * If moving the device from one location to another results in more than a 30°F change in temperature, allow the device 10 minutes to acclimate before using.

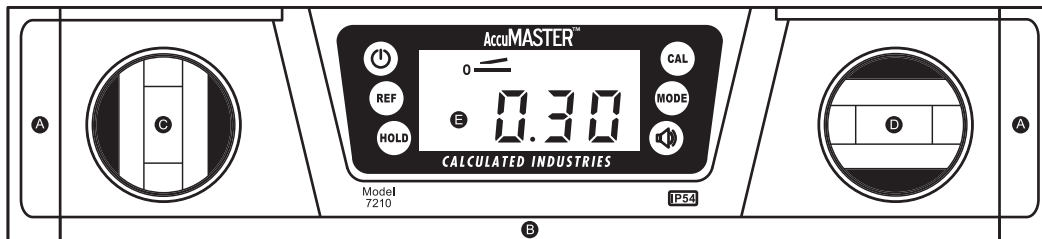

- Ⓐ Rubber end caps
- Ⓒ Vertical bubble vial
- Ⓚ Magnetized base
- Ⓓ Horizontal bubble vial
- Ⓛ LED display

Battery Instructions

Upon receipt – Use a small Phillips head screwdriver to remove rear cover. Unscrew the battery cover and remove protective tab. Replace the battery cover. Make sure the battery cover is completely tightened.

Includes

Batteries (2), protective case, user's guide, 2-year warranty

