



MONARCH INSTRUMENT

Instruction Manual



Nova-Pro 100

LED Stroboscope / Laser Tachometer



Safeguards and Precautions



1. Read and follow all instructions in this manual carefully, and retain this manual for future reference.
2. Do not use this instrument in any manner inconsistent with these operating instructions or under any conditions that exceed the environmental specifications stated.
3. Certain strobe frequencies can trigger epileptic seizures in those prone to that type of attack.
4. Users should not stare directly at the light source.
5. Prolonged exposure to the light can cause headaches in some people.
6. Objects viewed with this product may appear to be stationary when in fact they are moving at high speeds. Always keep a safe distance from moving machinery and do not touch the target.
7. There are no user serviceable parts in this instrument. Refer service to a qualified technician.
8. This instrument may not be safe for use in certain hazardous environments, and serious personal injury or death could occur as a result of improper use. Please refer to your facility's safety program for proper precautions.
9. Do not clean this instrument with alcohol or other cleaning solvents as these may damage the LEDs.
10. Nova-Pro Battery Packs contain Lithium Ion batteries which must be disposed of in accordance with Federal, State, & Local Regulations. Do not incinerate. Batteries should be shipped to a reclamation facility for recovery of the metal and plastic components as the proper method of waste management. Contact distributor for appropriate product return procedures.

LASER MODULE (Optional)



WARNING - This product emits a visible beam of laser light. Avoid exposure to the laser radiation. The use of optical viewing aids (binoculars, for example) may increase the ocular hazard.

CAUTION - The laser beam should not be intentionally aimed at people or animals.

CAUTION - Use of controls or adjustments or performance of procedures other than those specified herein may result in hazardous radiation exposure.



In order to comply with EU Directive 2012/19/EU on Waste Electrical and Electronic Equipment (WEEE): This product may contain material which could be hazardous to human health and the environment. DO NOT DISPOSE of this product as unsorted municipal waste. This product needs to be RECYCLED in accordance with local regulations, contact your local authorities for more information. This product may be returnable to your distributor for recycling - contact the distributor for details.

Monarch Instrument's Limited Warranty applies. See www.monarchinstrument.com for details. Warranty Registration and Extended Warranty coverage available online at www.monarchinstrument.com.

TABLE OF CONTENTS:

1. INTRODUCTION	1
2. USER INTERFACE	3
3. GETTING STARTED	5
3.1 Power.....	5
4. MODES OF OPERATION.....	6
4.1 STROBE Mode.....	6

4.1.1 Joystick.....	6
4.1.2 Doubling or Halving the Flash Rate	7
4.2 LASER Mode	8
4.3 TACH (Tachometer) Mode	9
5. MENUS.....	10
5.1 Menu Overview.....	10
5.2 MODE Menu.....	11
5.3 Brightness (BRITE) Menu	12
5.3.1 Degrees	12
5.3.2 Time	13
5.4 DECPT (Decimal Point) Menu.....	13
5.5 UNITS Menu	14
6. STROBE BRIGHTNESS.....	14
6.1 Calculating Blur	15
6.2 Brightness in Degrees of Rotation	16
6.3 Brightness in Pulse Duration.....	16
7. BATTERY PACK	17
7.1 Low Battery Functionality	17
7.2 Charging the Battery Pack.....	18
8. AC POWER OPTION	19
9. WALL POWER SUPPLIES.....	19
10. SPECIFICATIONS	20
10.1 Operating Environment	21
10.2 Compliance	21
10.2.1 Battery Compliance.....	21
10.2.2 EU Declaration of Conformity	21

1. INTRODUCTION

The Nova-Pro 100 is a portable hand-held LED Stroboscope used for inspection and to stop motion of rotating objects. The Nova-Pro 100 is available as battery powered or AC mains powered. An optional Laser Module is available which can be used to synchronize the strobe flash to a remote target or used as a laser tachometer to determine the speed of rotating objects (Tach Mode).

The features of the Nova-Pro 100 are highlighted in Figure 1 and Table 1.

Figure 1 Nova-Pro 100 Features

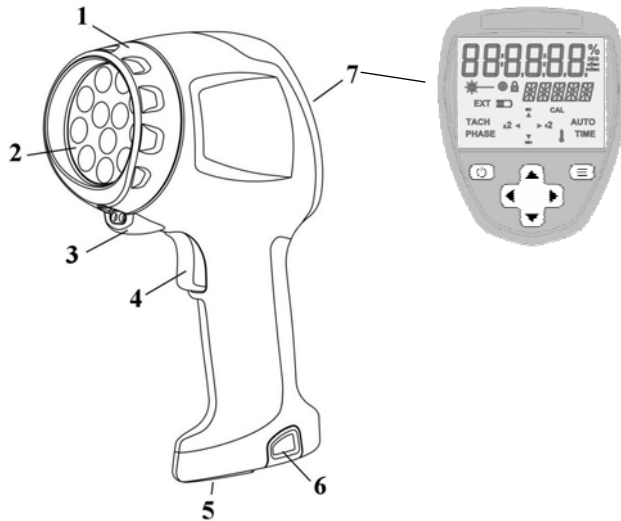

1,2	Bezel and Lens	Bezel is removable to add or remove the optional Laser Module
3	Laser Module (Optional Accessory)	Internal laser used to synch the flash to an external marker on the object under inspection. Can also be used in Tachometer Mode.
4	Trigger	Used to activate the unit (when power is on)
5	Tripod Mount	1/4 -20 tripod mount for hands free operation
6	Power Source	Battery Pack—Removable battery pack. Recharged in the external battery Charger Base OR AC Power—Plug in for continuous power
7	User Interface	<ul style="list-style-type: none"> Dedicated keypad with “joystick” button for adjusting flash rate. LCD (Liquid Crystal Display)

1

2

2. USER INTERFACE

The Nova-Pro 100 user interface consists of a large display, dedicated keys on the user interface panel and a trigger to activate the unit when the power is on. The user interface is described in Figure 2 and Table 2.

Figure 2 Nova-Pro 100 User Interface

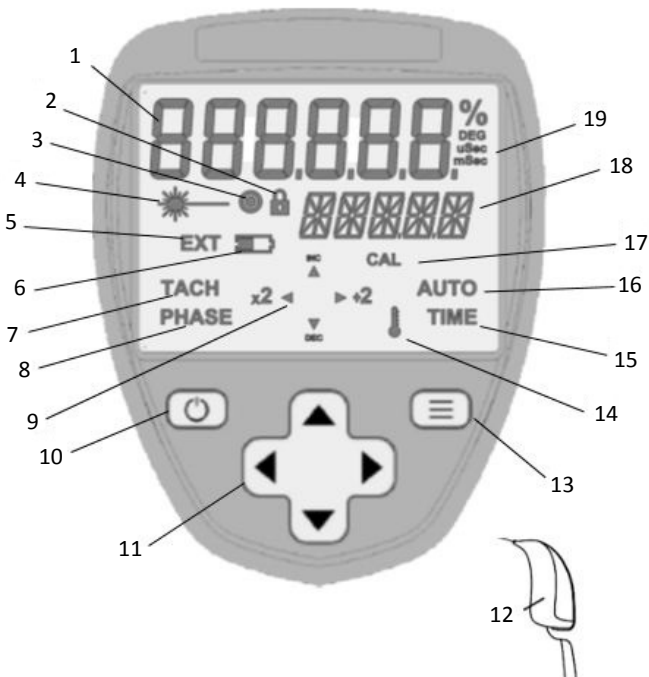

1	6-digit display used to display flash rate and other numeric values
2	Lock icon—Active when the device is locked on.
3	On Target indicator—Active when the input/laser is locked on to a target. Also used to indicate current selection in the menus.
4	Laser icon—Indicates that the laser is armed (flashing) or on (solid).
5	EXT icon—Not used
6	Battery icon—Active when the battery is low.
7	TACH icon—Active when Tachometer Mode is selected.
8	PHASE icon—Not used
9	x2, ÷2 and arrows—Used to indicate joystick (11) function.
10	POWER button—Turns the unit on and off. Also used as escape/back button in menus and trigger lock.
11	Joystick—Adjusts flash rate. Also used for menu navigation.
12	Trigger—Used to activate the unit when the power is on.
13	MENU button—Allows access to the menus. Also used to confirm selections.
14	Temperature icon—Active when the system is over heated. See section 10.1 .
15	TIME icon—Not used
16	AUTO icon—Not used
17	CAL icon—Active if the unit requires calibration
18	5-digit alphanumeric display used for general messaging
19	Engineering units—for brightness settings

3. GETTING STARTED

3.1 Power



The battery powered Nova-Pro has a removable Battery Pack that should be charged before use (see [section 7](#)). The Battery Pack is keyed to ensure correct insertion into the Nova-Pro and Battery Charger. **Make sure to remove the tape protecting the battery terminals and charge the battery before use.**



The AC powered Nova-Pro has an external power adapter that must be plugged into an AC outlet (115 Vac or 230 Vac) using the appropriate connector. Interchangeable plugs allow for operation in most countries (see [section 9](#)).



With the power source (battery or AC) inserted into the Nova-Pro, turn the unit on by pressing and holding the POWER button  until the display illuminates, then release the button. To operate the unit, pull the trigger.

The unit can be locked in continuous operation by pressing the POWER button  while squeezing the trigger. Keep holding the POWER button as you release the trigger and the Lock icon  will show on the display. To remove the lock simply pull the trigger.

To turn the unit off press and hold the POWER button  until the display shows OFF and then release. The unit will automatically power off after 3 minutes.

5

4. MODES OF OPERATION

The Nova-Pro 100 has a single mode of operation: **STROBE**, UNLESS the optional **Laser Module** is installed in the unit. This adds two additional modes:

LASER—uses the laser beam to trigger the stroboscope so that the flashes may be synchronized to an external target such as a keyway in a shaft or a piece of reflective tape on a fan blade.

TACH (Tachometer) - uses the laser to measure the speed of a rotating or reciprocating target using reflections from a keyway in a shaft or a piece of reflective tape on a fan blade.

The mode of operation is selected in the MODE menu. See [section 5.2](#).

4.1 STROBE Mode

In this mode the strobe generates the flash rate set by the user. The strobe will not flash until the trigger is depressed. The user can set the flash rate as follows:

4.1.1 Joystick

Pressing any button on the joystick will cause a digit on the display to start blinking—this is the digit that will be edited. There is a rollover effect when the digit is changed—if incrementing the units digit 99 will roll over to 100. If the user does not increment or decrement a digit within 5 seconds the edit mode will be cancelled.



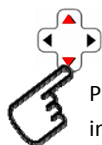

Press ◀ or ▶ to change the digit that blinks



Press ▲ or ▼ to increase or decrease the value of the blinking digit. Hold for auto increment or decrement

4.1.2 Doubling or Halving the Flash Rate

Press the MENU button  and the display will show the x2 and ÷2 icons. Use the left ◀ and right ▶ buttons on the joystick to double or halve the flash rate. Press the POWER button  to exit this mode.



Press the MENU button twice

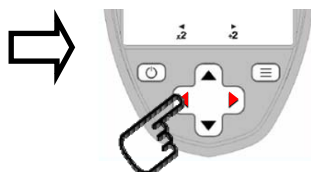

Use joystick or touch icons on display to x2 or ÷2

To confirm that the strobe is flashing at the same rate that the target is moving and that the RPM/RPS reading is accurate, use the x2 button until you see a double or multiple image, then use the ÷2 button until you see a single image. This will now be the correct speed (see [Figure 3](#)).

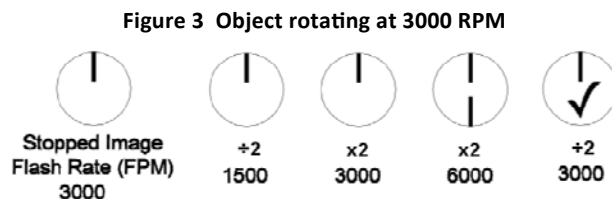

NOTE: If doubling or halving the flash rate causes the strobe to exceed its range, the display flash rate will remain at the current flash value.

4.2 LASER Mode

The Laser Mode is only available when the optional Laser Module is installed. This mode uses the LASER to trigger the strobe flash.



Laser icon will blink when Laser Mode is enabled and be on solid when trigger is pulled and laser is on

By pulling the trigger and aiming the laser at a reflective target on the rotating or reciprocating machine, the strobe will flash each time a reflection is received allowing the user to virtually “stop motion”.



On-Target icon will show on the display when target is detected by laser

The flash rate (speed) will be displayed in the selected units. See [Figure 4](#).

Figure 4 Using the Laser Module



CAUTION:

- AVOID EXPOSURE—LASER RADIATION IS EMITTED FROM THIS APERTURE
- AVOID DIRECT EXPOSURE TO BEAM
- DO NOT STARE DIRECTLY AT THE LASER SOURCE
- NEVER VIEW LASER SOURCE THROUGH OPTICAL INSTRUMENTS

4.3 TACH (Tachometer) Mode

The TACH (Tachometer) Mode is only available if the optional Laser Module is installed. This mode uses the laser to measure rotational speed.

TACH Tachometer icon will show on the display when the Nova-Pro is in TACH Mode.

Unit will NOT FLASH in Tachometer Mode.





 Laser icon will blink when Laser Mode is enabled and be on solid when trigger is pulled and laser is on

Pull the trigger and aim the laser at a reflective target on a rotating or reciprocating target. The speed will be displayed in the selected units.



 On-Target icon will show on the display when target is detected
Refer to Figure 4 Using the Laser Module and associated warnings.

Once in the Setup menu:



-  Use the ▲ and ▼ arrows on the joystick to scroll through the different available menu options.
-  Press the MENU button to enter menu options and make selections.
-  Press the POWER button to escape or back out of the menus.
-  On-Target icon will show which menu option is selected.



The following sections describe the individual menu options.

5.2 MODE Menu

Only available if optional Laser Module is installed.

MODE choices are: **tACH** (Tachometer), **StroBE** or **LASER**. The modes are described in [section 4](#).

Press the MENU button  to enter the MODE menu. The top line will show the mode and the On-Target indicator  will be on for the currently selected mode.

-  Use the ▲ and ▼ arrows on the joystick to select the desired mode.
-  Press the MENU button to select the desired mode. This will change the mode and exit the menu.
-  Press the POWER button to escape *without changing* the mode.

5. MENUS

5.1 Menu Overview

The menu that shows is dependent on the current operating mode of the unit and whether the Laser Module is installed.

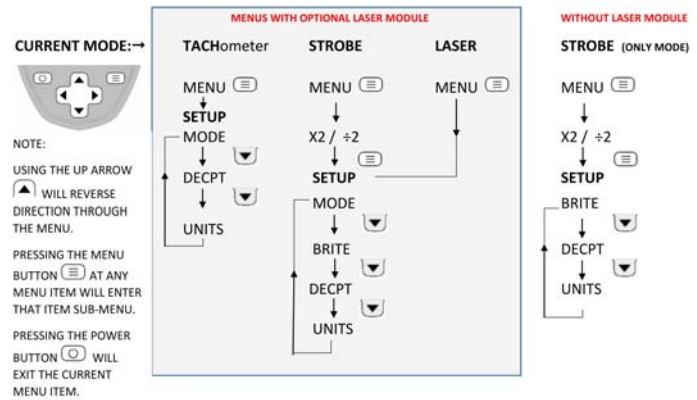

To enter the menus, press the MENU button once or twice depending on the current mode (see overview above) until the word SETUP appears on the top line of the display. To select the current item shown on the lower line press the MENU  button again. Not all items will be available in the menu; it depends on the operating mode.

5.3 Brightness (BRITE) Menu

Refer to [Section 6](#) for details on Brightness and Flash Duration before using this feature.



The Brightness (BRITE) menu option sets the flash duration which affects the brightness. Flash duration can be adjusted in degrees of rotation (proportional flash duration—changes with flash rate) or time in milliseconds (msec—fixed flash duration). The flash duration will be set by the last flash duration value adjusted. If you adjusted degrees, the strobe will have a flash duration in degrees proportional to the flash rate. If the adjustment was in time, the strobe will have a fixed duration irrespective of the flash rate.

This is a live adjustment—if the trigger is depressed, the effect of changing the brightness can be seen immediately.

5.3.1 Degrees

Press the MENU button  to enter the BRITE menu. The current flash duration will be shown in degrees.

 Use the arrows on the joystick to adjust the flash duration in degrees - refer to [section 4.1.1](#). Degrees can be set from 0.1° to 14°.

Press the MENU button  followed by the Power button  to save the degree setting.



To exit without setting the flash duration press the Power button .

5.3.2 Time

To set the flash duration in time instead of degrees, press the MENU button  again (skip the DEG menu).





Use the arrows on the joystick to adjust to the time value. Time can be set from 0.001 mSec to 2.000 mSec.

Press the MENU button  followed by the Power button  to save the time setting.



To exit without setting the flash duration in time press the Power .

5.4 DECPT (Decimal Point) Menu

The Decimal Point menu adjusts the resolution of the Flash/Tach rate displayed. Up to three places after the decimal point can be shown. The number of decimal places is limited by the 6-digits available and the unit will auto range to show the maximum number of digits after the decimal point selected by the user. The choices are NONE, 1, 2, 3. A value of 600 will be displayed as 600, 600.0, 600.00, 600.000 depending on the setting.

Press the MENU button  to enter the DECPT menu. The current value is shown on the top line with DECPT on the lower line. The On-Target indicator  will be on for the currently selected value.

 Use the arrows on the joystick to select the desired value.

Press the MENU button  followed by the Power button  to save the decimal point setting.

To exit without setting the decimal point press the Power button .

13

the shaft appeared to be stopped. As the target is rotating there is some movement evident during the strobe flash. The longer the flash duration, the more obvious the rotation is and this increases the blur.

6.1 Calculating Blur

Blur can be calculated— if the shaft is turning at 6000 RPM, it takes 10 msec to complete one revolution. If the strobe flash duration is 100 μ sec (1/100 of a millisecond), the shaft will turn:

$(\text{flash duration}/\text{time per rotation}) \times 360^\circ$, which is $(.0001/.01) \times 360 = 3.6^\circ$. So you will see the shaft appear to move 3.6° .

As the flash pulse widens you will see greater degrees of rotation which results in more blur and a brighter perceived illumination (the LEDs are on longer so the average light the eyes see is greater). The trade off is blur versus brightness. The further away the rotating point is from the center axis the faster the tangential velocity and the worse the blur appears to be.

When setting the pulse duration in degrees, what you set is what you get. Refer to the image on the right for the difference between a 1° and 5° (of rotation) flash duration.

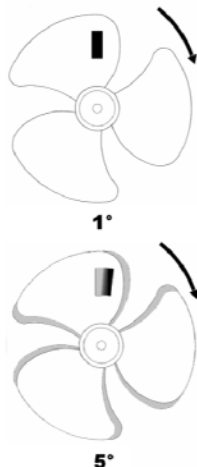

There are two methods of adjusting the flash pulse width and hence the brightness and consequently the blur. For setting Brightness see [section 5.3](#).





5.4 UNITS Menu

This menu option selects the Engineering Units used to display the flash rate or speed. The choices are:

- FPM - Flashes per Minute (Not available in TACH Mode)
- FPS - Flashes per Second (same as Hz, not available in TACH Mode)
- RPM - Revolutions per Minute
- RPS - Revolutions per Second (same as Hz)

Press the MENU button  to enter the UNITS menu. Unit is shown on the top line with the current engineering unit on the lower line. The On-Target indicator  will be on for the currently selected value.

 Use the arrows on the joystick to select the desired value.

Press the MENU button  followed by the Power button  to save the value.

To exit without setting the units press the Power button .

6. STROBE BRIGHTNESS

The strobe's brightness depends on how wide the strobe's flash pulse is; the wider the pulse, the brighter the flash from the LEDs appears to be. There is however, a downside to the wider pulses. All strobes work by giving short bursts of light (the pulse width) at a rapid repetition rate (the flash rate). Strobes rely on the persistence of the human eye (the ability to remember and image) and its response to bright light to give an apparent stop motion image. Imagine a shaft rotating at 6000 RPM or one rotation every 1/100 of a second (10 msec). If the strobe flashes once every 10 msec for a brief moment, the user sees the flash at the same spot in the rotation of the shaft and the persistence of the eye remembers this until the next flash making

14

6.2 Brightness in Degrees of Rotation

Brightness can be set from 0.2 to 14 degrees out of 360. The higher the setting the brighter the strobe appears to be but the more blurred the target is. Optimal setting to stop motion is 1.8 to 3.6° . The number of degrees is a proportional amount and remains constant as the flash rate increases or decreases. The strobe automatically calculates how wide the pulse width should be at different flash rates to keep the blur constant—the faster the flash rate the narrower the pulse width. The pulse width equals: $(\text{setting in degrees}/360) \times (1/\text{flashrate in Hz})$.

6.3 Brightness in Pulse Duration

Brightness can also be set to a fixed duration pulse in milliseconds. The flash rate remains constant irrespective of the flash rate, thus as the flash rate increases, the image will get brighter and more blurred.

Note: There are two limits maintained by the strobe – the flash pulse width can never be greater than 2.0 msec (milliseconds) nor can it exceed 14° of rotation.

The strobe automatically adjusts the pulse width and rotation values as the flash rate is increased or decreased to maintain the limits at all times. For example—a flash rate of 600 flashes per minute (10 Hz), 14° of rotation represents a flash pulse width of 3.8 msec. The strobe will limit this value to 2.0 msec or 7.3° of rotation (blur).

7. BATTERY PACK

When ordered as such, the Nova-Pro 100 comes with one rechargeable Lithium Ion battery pack, external charger and power supply. The Battery Pack is shipped in a mostly discharged state and has tape over the terminals.



REMOVE TAPE BEFORE USE. CHARGER BATTERY PRIOR TO USE.

CAUTION:

- Do not store battery in hot locations
- Do not expose to fire.
- Do not disassemble.
- Do not apply mechanical force.

REMOVE Battery Pack from unit before storing for long periods.

DO NOT DISPOSE of the Lithium-ion batteries as unsorted municipal waste. The batteries need to be **RECYCLED** in accordance with local regulations. The batteries should be sent to a recycling center or returned to the factory using appropriate shipping methods.

The Nova-Pro Battery Pack is specifically keyed to fit in the Nova-Pro and Charger Base one way only. Insert the Battery Pack into the Nova-Pro until the clips lock into place. To remove, squeeze clips on the Battery Pack to release from the Nova-Pro. The Battery Pack can also be screwed into the Nova-Pro using the attached captive screw.

7.1 Low Battery Functionality



Low battery icon will blink when battery pack needs to be recharged. The unit may still be used for a short time.

The Nova-Pro will display “LOBAT” and shut down when the battery pack is exhausted and must be recharged.

17

8. AC POWER OPTION

The Nova-Pro 100 can be ordered specifically with the AC Power Option for continuous operation from AC power. The AC Power Option can also be ordered as an accessory. Simply insert the AC Power Option into the Nova-Pro (matching the keyed slot) until it clicks into place and use the captive screw to secure into place. Then plug the wall power supply into an outlet (115Vac to 230Vac) using the appropriate interchangeable plug.



9. WALL POWER SUPPLIES



The wall power supplies provided with the Nova-Pro 100 have interchangeable plugs allowing them to be used with AC outlets in different countries.

To change the plugs, depress the button (1) and slide the plug up (2). Select the correct plug and slide it back into the power supply until the plug seats firmly. Make sure the plug cannot slide out.



CAUTION: RISK OF ELECTRIC SHOCK

- Do not insert the plugs into an AC outlet without the power supply attached.
- Avoid touching the plug blades when inserting or removing the power supply from the AC outlet.
- Indoor Use Only

7.2 Charging the Battery Pack

The Nova-Pro Battery Pack must be removed from the Nova-Pro to be charged using the Nova-Pro Charging Station (shown right) and power supply provided.

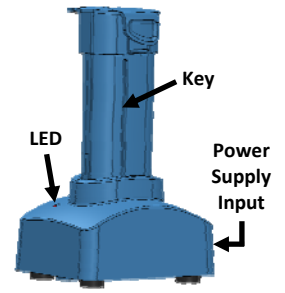

CAUTION: Never attempt to charge the Battery Pack with anything other than the Charging Station and power supply provided with the Nova-Pro.

The Nova-Pro Charging Station has an light emitting diode (LED) that indicates the state of the battery/station. The LED indicates the following:

Green	On / No Battery or Battery Charged
Red	Charging
Flashing Red	Error / Replace Battery

Battery charge time will be up to 6 hours depending on Battery Pack and residual charge. Once the battery is charged the charger will switch to trickle charge mode—the battery should be removed once the charge LED turns green.

18

10. SPECIFICATIONS

Flash Range	30 to 999,999 FPM/RPM
Display:	6 digit numeric and 5 digit alphanumeric LCD reflective
Accuracy/Resolution:	0.002% of setting ±1 lsd / 6 digits to 0.001
Light Source:	12 LED Array
Flash Duration:	Adjustable: 0.1 - 14 degrees
Light output:	3400 Lux @ 6000 FPM, 12 inches (30.48cm), 2" duty cycle, Max light output: 24,000 Lux
Color Temperature:	approx. 6200°K
Tachometer Mode:	0-999,999 RPM with integral laser (Optional)
Operating Time:	Standard pack: 9.5 hours typical (6000 FPM, 2" duty cycle) Optional High capacity pack: 19 hours typical (6000 FPM, 2" duty cycle)
Power Supply (Battery):	Removable/rechargeable UN38.3 compliant Li-ion battery pack Standard Battery: 7.4V 2.8Ah (21W) Optional High Capacity Battery: 7.4V 5.2Ah (38.5W)
Power Supply (A/C):	115/230 Vac 50/60Hz AC adapter with 6 foot (2m) cable and interchangeable outlet adapters (Optional)
Weight:	1.4 Lbs. (635 grams) with Standard battery 1.5 Lbs. (680 grams) with Optional Hi-capacity battery
Size (H x W x D):	9.5 x 3.75 x 5.5 in. (241 x 95 x 140 mm)
Housing Material / Rating	ABS / IP54

Product specifications are subject to change without notice.

10.1 Operating Environment

This equipment is NOT intended for permanent installation.

This equipment is for use in a controlled environment - Environmental situation A, Pollution Degree 2.

Altitude: up to 2000 m

Temperature: 5 °C to 40 °C

NOTE: The [Temperature icon](#) will turn on if the LED array exceeds 75 °C and the unit will reduce flash duration to lower temperature. The unit will shut off if the temperature exceeds 85 °C.

Humidity: Maximum relative humidity 80% for temperatures up to 31 °C decreasing linearly to 50% relative humidity at 40 °C.

Rating: Splash proof—IP 54

Category: 2

10.2 Compliance

10.2.1 Battery Compliance

The Lithium-Ion battery packs used in this product meet the requirements of **UN DOT 38.3**.

Tested by Shenzhen SEM.Test Technology Co. Ltd. (Reports STR16079052S/54S).

10.2.2 EU Declaration of Conformity

Please visit our website www.monarchinstrument.com to download our EU Declaration of Conformity for this product.

21

T-5 Reflective tape - 5 foot [1.5 m] roll, 0.5 inch [12.7 mm] wide

CAL-N.I.S.T N.I.S.T. Traceable Certificate of Calibration / Recalibration

12. OPTIONS and ACCESSORIES

Laser Module Optional Laser Module enables the Nova-Pro 100 to be used as a laser tachometer or to synchronize the strobe flash to a remote target 

Laser Module Dock Optional docking station for Laser Module which can be removed from the Nova-Pro to be used as an external laser sensor. Comes with blanking panel for Nova-Pro 

AC Adapter Replacement/optional 115/230 Vac 50/60 Hz AC Adapter with 6 foot (2 m) cable with USA, UK, AUS, Euro adapter plugs 

Charging Station Replacement Charging Station for Nova-Pro Li-Ion Battery Packs. Includes 115/230 Vac power supply with USA, UK, AUS, Euro adapter plugs 

Charger Power Supply Replacement power supply for use with Charging Station: 115/230 Vac with USA, UK, AUS, Euro adapter plugs

Standard Battery Pack Replacement Standard Li-Ion Battery Pack

Hi-capacity Battery Pack Optional Long Life Li-Ion Battery Pack

Standard Carry Case Latching carrying case for Nova-Pro with provision for accessories (included with Nova-Pro 100 Kit)

Deluxe Carry Case Deluxe water-tight latching carrying case for Nova-Pro with provision for accessories

22

Check out our other product lines...



Handheld Tachometers



Panel Tachometers



Portable Stroboscopes



Machine Vision Stroboscopes



Speed Sensors



Temperature/Humidity Sensors



Vibration Meters



Paperless Recorders



Track-It® Data Loggers

Printed in the U.S.A.

Copyright 2016 Monarch Instrument, all rights reserved