



MONARCH INSTRUMENT

Instruction Manual



CE

BC

NIST
CALIBRATION

Pocket LED Strobe
Portable LED Stroboscope



Safeguards and Precautions



1. Read and follow all instructions in this manual carefully, and retain this manual for future reference.
2. Do not use this instrument in any manner inconsistent with these operating instructions or under any conditions that exceed the environmental specifications stated.
3. Certain strobe frequencies can trigger epileptic seizures in those prone to that type of attack.
4. Users should not stare directly at the light source.
5. Prolonged exposure to the light can cause headaches in some people.
6. Objects viewed with this product may appear to be stationary when in fact they are moving at high speeds. Always keep a safe distance from moving machinery and do not touch the target.
7. There are no user serviceable parts in this instrument. Refer service to a qualified technician.
8. Do not allow liquids or metallic objects to enter the stroboscope as this may cause permanent damage and void the warranty.
9. Do not clean this instrument with alcohol or other cleaning solvents as these may damage the LEDs.
10. The Pocket LED Strobe contains Lithium Ion batteries which must be disposed of in accordance with Federal, State, & Local Regulations. Do not incinerate. Batteries should be shipped to a reclamation facility for recovery of the metal and plastic components as the proper method of waste management. Contact distributor for appropriate product return procedures.
11. This instrument may not be safe for use in certain hazardous environments, and serious personal injury or death could occur as a result of improper use. Please refer to your facility's safety program for proper precautions.



In order to comply with EU Directive 2012/19/EU on Waste Electrical and Electronic Equipment (WEEE): This product may contain material which could be hazardous to human health and the environment. **DO NOT DISPOSE** of this product as unsorted municipal waste. This product needs to be **RECYCLED** in accordance with local regulations, contact your local authorities for more information. This product may be returnable to your distributor for recycling - contact the distributor for details.

Monarch Instrument's Limited Warranty applies.
See www.monarchinstrument.com for details.

Warranty Registration and Extended Warranty coverage available online at www.monarchinstrument.com.

TABLE OF CONTENTS:

1.0	INTRODUCTION	1
2.0	USER INTERFACE	2
3.0	GETTING STARTED	3
3.1	Power	3
3.2	Input/Output Connections	3
4.0	MODES OF OPERATION.....	4
4.1	Internal Strobe Mode	5
4.1.1	Adjusting the Flash Rate - RPM.....	5
4.1.2	Doubling or Halving the Flash Rate.....	5
4.2	External Mode	6
4.3	Charging Mode.....	6
5.0	MENU OPTIONS	6
5.1	MODE	7
5.2	BRITE (Brightness)	8
5.3	SAVE	8
5.4	LOAD.....	9
5.5	UNITS.....	9
5.6	BKLIT (Backlight).....	9

5.7	DECPT (Decimal Point).....	10
5.8	INPUT (INput Pulse Polarity)	10
6.0	STROBE BRIGHTNESS	11
6.1	Calculating Blur	11
6.2	Brightness in Degrees of Rotation	12
6.3	Brightness in Pulse Duration	12
7.0	USING THE STROBOSCOPE TO MEASURE RPM.....	13
8.0	BATTERIES	15
8.1	Low Battery Indication	15
8.2	Charging the Batteries.....	15
8.3	Battery Disposal	16
9.0	SPECIFICATIONS	17
10.0	SENSORS / ACCESSORIES and PARTS.....	19

Monarch Instrument holds the following US trademarks and registrations, all rights reserved: Track-It™, Nova-Pro® , Nova-Strobe™, Data-Chart™, illumiNova®

1.0 INTRODUCTION

The Pocket LED Strobe (PLS) is a rugged, portable battery powered LED (Light Emitting Diode) stroboscope used for inspection and to stop motion to determine the speed of rotating objects. The unit is ergonomically designed for comfortable hand held operation or it may be mounted on a tripod using the integral 1/4 -20 UNC bushing on the underside of the unit.

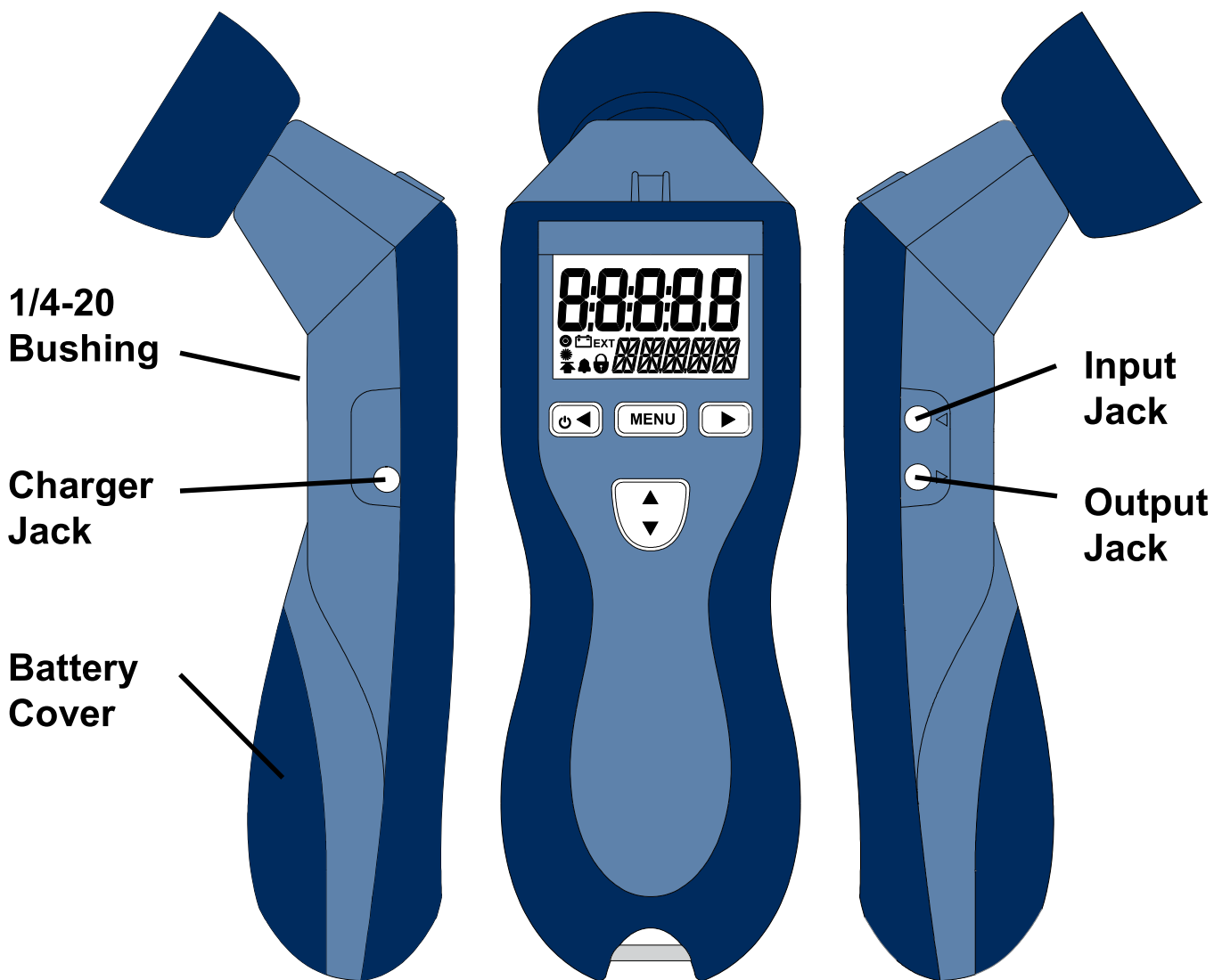

Figure 1 Pocket LED Strobe

2.0 USER INTERFACE

The Pocket LED Strobe has a two-line backlit alpha-numeric liquid crystal display (LCD) and a four-key keypad that enables the user to control the operation of the unit. The user interface is described in Figure 2 and Table 2.

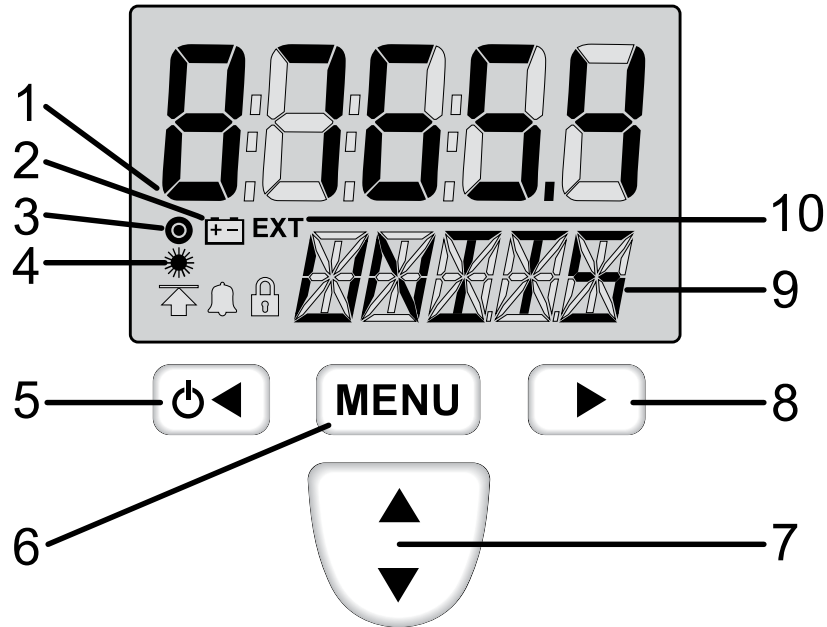

Figure 2 Pocket LED Strobe User Interface



Table 2 Pocket LED Strobe User Interface	
1	5-digit display used to display flash rate and other numeric values
2	Battery icon - Active when the battery is low
3	On Target Indicator - Active when the input is locked on to a target
4	Star icon - Used to indicate current selection in the menus
5	POWER / LEFT Arrow button - Turns the unit on and off. Also used as LEFT Arrow for adjustments
6	MENU button - Allows access to the menus. Also used to confirm selections
7	UP/DOWN button - Used to adjust flash rate and menu navigation
8	RIGHT Arrow - Used to adjust flash rate and menu navigation
9	5-digit alphanumeric display used to display units and other statuses
10	EXT icon - Active when an external source is plugged into the unit

3.0 GETTING STARTED

The Stroboscope may be hand held or mounted on a tripod or other user supplied bracket using the 1/4-20 UNC bushing on the underside of the unit.

3.1 Power

The LED Strobe is battery powered and has internal rechargeable batteries. The unit should be charged before use (see Section 8.0). The actual operating time of the stroboscope depends on the flash pulse width. Narrower flash widths increase the operating time.

To turn on the stroboscope, depress and hold the POWER button  until the display shows the rev level - $REV \times \times \times$ then release the button. The unit will start up with the same settings in which it was last left. To turn the power off, hold the POWER button  until the display shows OFF then release it.

3.2 Input / Output Connectors

The strobe has input and output jacks on the right side of the stroboscope. These can be used for external triggering or synchronization (daisy-chaining two or more strobes). These jacks accept 1/8" (3.5mm) phone plugs (input - stereo, output - mono). The input and output signals are TTL compatible. Connection details are shown in Figures 3 and 4 on the next page.

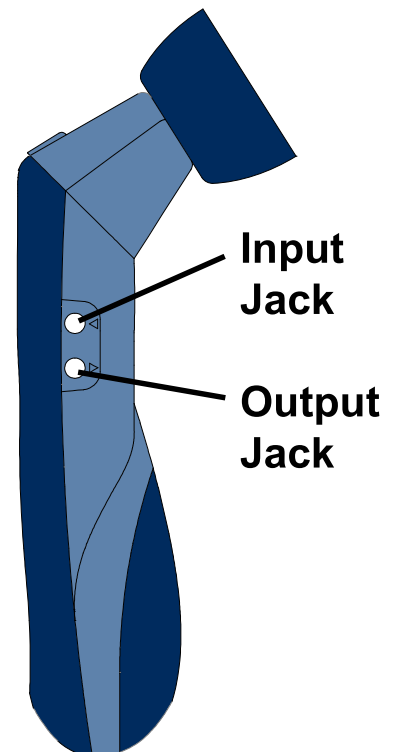

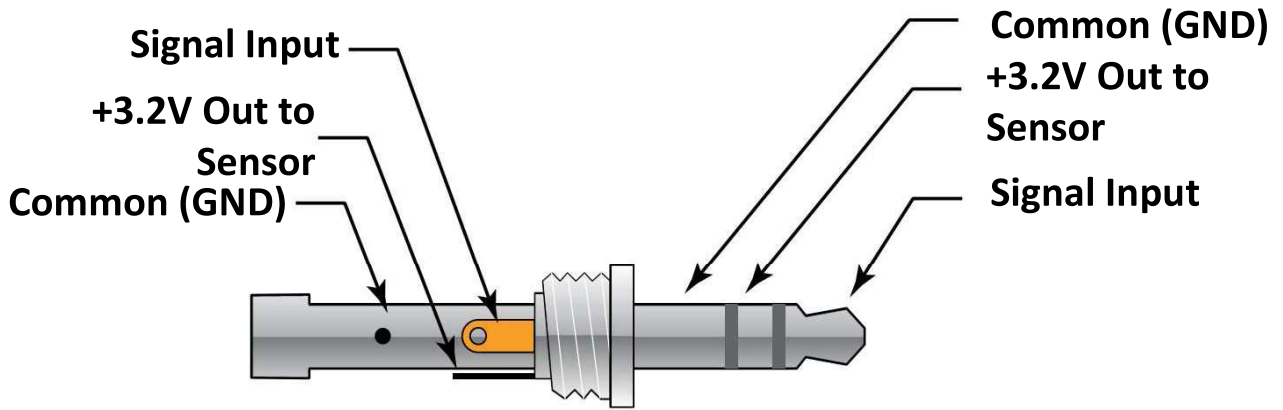

Figure 3 Input Connector Detail (Stereo plug)

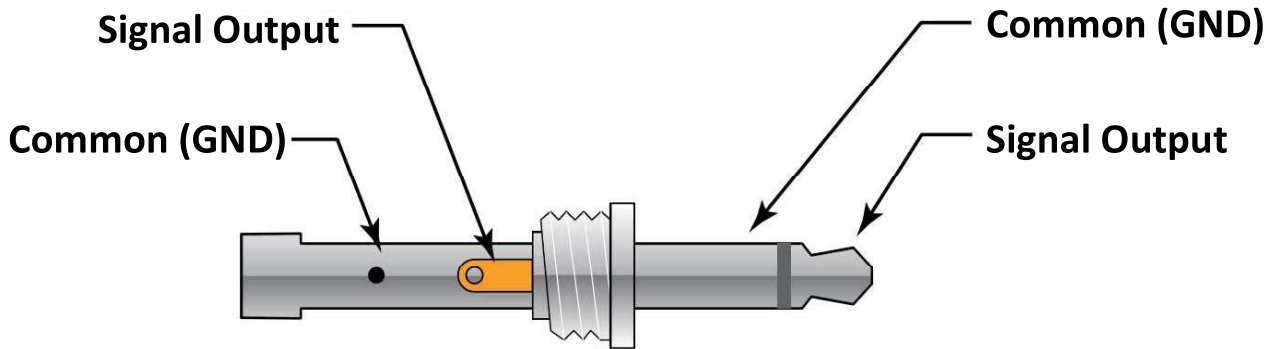

Figure 4 Output Connector Detail (Mono plug)

With no external input, the output jack provides a TTL compatible pulse from the strobe’s internal oscillator. If an external input is applied, the output pulse is in sync with the input pulse. This output pulse may be used to trigger a second stroboscope synchronously to illuminate larger areas. Many strobes can be “daisy chained”. The output jack of one strobe is connected to the input jack of the next strobe causing all the strobes to flash together and be controlled by the first strobe in the chain.

Note: Cables should not exceed 8 feet or 2.5 meters in length in order to comply with the CE rating of this product.

4.0 MODES OF OPERATION

The stroboscope has two basic modes of operation – INTERNAL and EXTERNAL. The unit does not operate when in the Charging Mode.

4.1 Internal Mode

The strobe is in the Internal Mode when nothing is plugged into the input jack. In the internal mode the strobe generates its own timing signals and the user can adjust the flash rate as described below.

4.1.1 Adjusting the Flash Rate - RPM

The flash rate can be adjusted by pressing the large UP/DOWN button. Pressing the UP end of the button ▲ will increase the flash rate and pressing the DOWN end of the button ▼ will decrease the flash rate. The flash rate can be adjusted in decades by pressing the LEFT ◀ or RIGHT ▶ buttons which will change which digit is adjusted. The active digit will blink. As the flash rate is increased or decreased, the active digit will roll over to the next significant digit. The LEFT and RIGHT digit selection will wrap around as shown below.

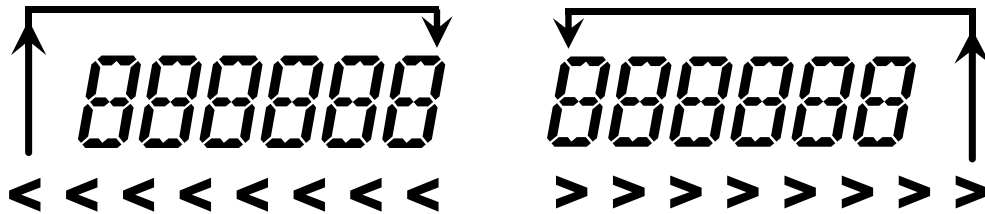

4.1.2 Doubling or Halving the Flash Rate

The strobe flash rate can be instantly doubled (x2) or halved ($\div 2$) by pressing the **MENU** button. The lower display will show $\times 2 / \div 2$. Pressing the UP/DOWN button will double ▲ or halve ▼ the flash rate. This is useful in determining actual rotational speed – refer to the section on speed measurement – Section 7. Note that if doubling or halving the flash rate will cause the strobe to exceed its capability, the unit will be limited to the highest or lowest value it can generate respectively. To exit this mode, press the LEFT ◀ button.

4.2 External Mode

In the External Input Mode the user can't make any flash rate adjustments. The flash rate is a function of the input signal. This mode is used to synchronize the flash to an external event (for example, from an optical sensor) to stop or freeze motion. The flash will be triggered on the rising or falling edge (menu selectable) of the external input pulse.

The input jack enables an external signal to trigger the strobe. Inserting a plug into the input jack will automatically put the strobe into the External Mode. When the strobe is in the External Input Mode, **EXT** will be displayed.

When an external input is applied to the unit and the strobe is put in the Tachometer Mode, the unit will read the signal from the external input (sensor) and display the reading on the LCD display without flashing the lamp. When there is a valid external signal the on target indicator  will turn on. **The strobe will not flash in the Tach (Tachometer) Mode.**

To exit the External mode, remove the device from the input jack and the strobe will be put back into the Internal Mode.

4.3 Charging Mode

The Charging Mode is when the strobe has the battery recharger plugged into it. The strobe will not operate while charging. The status of the charge is indicated by the LED on the charger. While charging the LED on the charger is RED; when the charge is complete the LED will turn GREEN. **USE ONLY THE CHARGER SUPPLIED WITH THE STROBE - Model LBC-U.**

5.0 SETUP MENU OPTIONS

To enter the Setup Mode it is necessary to press the MENU button **twice**. The first press will enter the x2 /2 mode as described in section 4.1.2; the

second press will enter the Setup Mode. The top line of the display will show *SETUP* and the bottom line will show the setup options. Use the UP/DOWN button ▲ ▼ to scroll through the setup options. Press the MENU button at any time to select that setup option. Note that currently selected options are indicated by the star icon (✱).

Setup options are in order as follows:

MODE > BRITE > SAVE > LOAD > UNITS > BKLIT > DECPT > INPUT

These options are described in the following sections. Note that the order of the options within each setup option may change depending on current operating settings.

5.1 MODE

Set the strobe into the flash (strobe) mode or the tachometer (no flash) mode. When the display shows:

```
SETUP
  MODE
```

Press the **MENU** button to enter. The mode can be set to Tach or Strobe.

Tach - No LED flash - use external input to show RPM

```
TACH
  MODE
```

Press **MENU** to save and return to the main menu, or use UP/DOWN button ▲ ▼ to change to:

Strobe - Internal generator - flash LEDs

```
StroBE
  MODE
```

Press **MENU** to save and return to the main menu or press ◀ to return to the main menu without saving. The unit will indicate **DONE** when the value has been changed.

5.2 BRITE (Brightness)

Adjust the flash pulse width and consequently the brightness. See Section 6.0. When the display shows:

```
SETUP  
BRITE
```

Press the **MENU** button to enter. Width can be set in degrees or microseconds.

DEG - Set the flash width in degrees from 0.1° to 10.0°. Use the UP/DOWN button ▲▼ to change the degrees in 0.1° steps. Note that the decade being edited can be changed using the LEFT ◀ or RIGHT ▶ buttons.

```
5.6  
DEG
```

Press the **MENU** button to move to microseconds.

uSEC - Set the flash width in microseconds from 0.5 to 1300 μsec. The display will default to a conversion of the degrees to microseconds for the current flash rate.

```
1234  
uSEC
```

To accept this press **MENU** again. To adjust the flash rate in microseconds, use the ▲▼ button. Note that the decade being edited can be changed using the LEFT ◀ or RIGHT ▶ buttons.

Press **MENU** to save and return to the main menu.

5.3 SAVE

Saves the current flash rate to a memory location. When the display shows:

```
SETUP  
SAVE
```

Press **MENU** to select, use the UP/DOWN button ▲▼ to select a

memory location, press **MENU** to select the location. The flash rate is shown on the top row, memory location on the bottom row (see below).

3600

SM 3 (SM = Save Memory)

Press **MENU** to save and **EXIT OUT OF MENU**. The unit will indicate **DONE** when the value has been changed.

5.4 LOAD

Loads the saved flash rate from a memory location. Press **MENU** to select, use the UP/DOWN button ▲ ▼ to select the memory location, press **MENU** to select. The flash rate is shown on the top row, memory location on the bottom row (see below).

3600

RM 3 (RM = Recall Memory)

Press **MENU** to recall flash rate and **EXIT OUT OF MENU**.

5.5 UNITS

Selects the engineering units for the display. When the display shows:

SETUP

UNITS

Press **MENU** to select, use the UP/DOWN button ▲ ▼ to select the units. The units depend on the MODE of the unit. The options are RPM/RPS (Revolutions per Minute/Second).

Unit

RPM

Press **MENU** to save and exit back to the main menu or press ◀ to return to the main menu without saving. The unit will indicate **DONE** when the value has been changed.

5.6 BKLIT (Backlight)

Turns the display backlight on or off. When the display shows:

SETUP

BKLIT

Press **MENU** to select, use the UP/DOWN button ▲ ▼ to select on or off. As the status changes, the backlight will activate accordingly.

```
OFF
  BKL IT
```

Press **MENU** to save and exit back to the main menu.

5.7 DECPT (Decimal Point)

Set the number of decimal places to display. When the display shows:

```
SETUP
  DECPT
```

Press **MENU** to select, use the UP/DOWN button ▲ ▼ to select none, 1 or 2.

```
none
  DECPT
```

Press **MENU** to save and exit back to the main menu or press ◀ to return to the main menu without saving. The unit will indicate **DONE** when the value has been changed.

5.8 INPUT (Input Pulse Polarity)

Set the active edge of the input pulse. When the display shows:

```
SETUP
  INPUT
```

Press **MENU** to select, use the UP/DOWN button ▲ ▼ to select NEGative or POSitive.

```
neg
  EDGE
```

Press **MENU** to save and exit back to the main menu or press ◀ to return to the main menu without saving. The unit will indicate **DONE** when the value has been changed.

At the MAIN MENU press the LEFT ◀ button to exit to the operational condition.

6.0 STROBE BRIGHTNESS

The strobe's brightness depends on how wide the strobe's flash pulse is; the wider the pulse, the brighter the flash from the LEDs appears to be. There is however, a downside to the wider pulses. All strobes work by giving short bursts of light (the pulse width) at a rapid repetition rate (the flash rate). Strobes rely on the persistence of the human eye (the ability to remember and image) and its response to bright light to give an apparent stop motion image. Imagine a shaft rotating at 6000 RPM or one rotation every 1/100 of a second (10 msec). If the strobe flashes once every 10 msec for a brief moment, the user sees the flash at the same spot in the rotation of the shaft and the persistence of the eye remembers this until the next flash making the shaft appeared to be stopped. As the target is rotating there is some movement evident during the strobe flash. The longer the flash duration, the more obvious the rotation is and this increases the blur.

6.1 Calculating Blur

Blur can be calculated— if the shaft is turning at 6000 RPM, it takes 10 msec to complete one revolution. If the strobe flash duration is 100 μ sec (1/100 of a millisecond), the shaft will turn: (flash duration/time per rotation) x 360°, which is $(.0001/.01) \times 360 = 3.6^\circ$. So you will see the shaft appear to move 3.6°.

As the flash pulse widens you will see greater degrees of rotation which results in more blur and a brighter perceived illumination (the LEDs are on longer so the average light the eyes see is greater). The trade off is blur versus brightness. The further away the rotating point is from the center axis the faster the tangential velocity and the worse the blur appears to be.

When setting the pulse duration in degrees, what you set is what you get. Refer to the image on the right for the difference between a 1° and 5° (of rotation) flash duration.

There are two methods of adjusting the flash pulse width and hence the brightness and consequently the blur.

6.2 Brightness in Degrees of Rotation

The first method is to adjust the flash pulse width for degree of rotation visible (blur). The user can set this from 0.1 to 10 degrees out of 360. The higher the setting, the brighter the strobe appears to be but the more blurred the target is. Optimal setting to stop motion is 1 to 3.6°. The number of degrees is a proportional amount and remains constant as the flash rate increases or decreases. The strobe automatically calculates how wide the pulse width should be at different flash rates to keep the blur constant – the faster the flash rate, the narrower the pulse width. The pulse width equals:

$(\text{setting in degrees}/360) \times (1/\text{flash rate in Hz})$.

Thus the blur remains constant no matter what the flash rate*.

6.3 Brightness in Pulse Duration

The second method is to adjust the flash pulse width to a fixed number of microseconds. Here the user sets the flash pulse width in microseconds not degrees. As the flash rate increases, the pulse width stays the same* and the image will get brighter and more blurred as the flash width

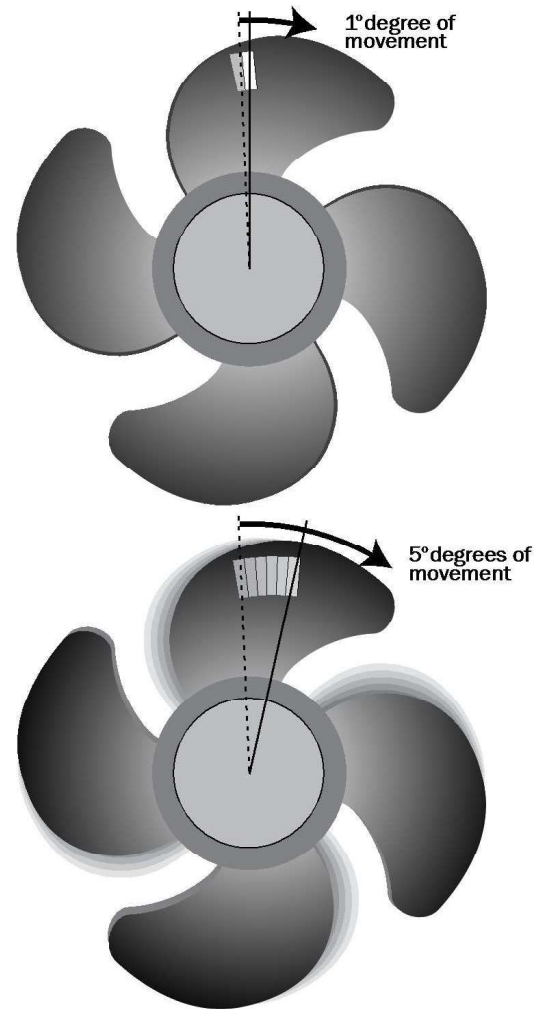

remains constant*. The degree of rotation visible changes to keep the pulse width of the flash constant*.

***Note:** There are two limits maintained by the strobe – the pulse can never be greater than 1300 μ s nor can it exceed 10° of rotation. The strobe automatically adjusts these values as the flash rate is increased or decreased to maintain these limits at all times.

7.0 USING THE STROBOSCOPE TO MEASURE RPM

The primary use for a stroboscope is to stop motion for diagnostic inspection purposes. However the stroboscope can be used to measure speed (in RPM / RPS). In order to do this several factors need to be considered. First, the object being measured should be visible for all 360° of rotation (e.g. The end of a shaft). Second, the object should have some unique part on it, like a bolt, key way or imperfection to use as a reference point. If the object being viewed is perfectly symmetrical, then the user needs to mark the object with a piece of tape or paint in a single location to be used as a reference point. Look only at the reference point.

If the speed of rotation is within the range of the stroboscope, start at a higher flash rate and adjust the flash rate down. At some point you will stop the motion with only a single reference point of the object in view. Note that at a flash rate twice the actual speed of the image you will see two images (reference points). As you approach the correct speed you may see three, four or more images at harmonics of the actual speed. The first SINGLE image you see is the true speed. To confirm the true speed, note the reading and adjust the stroboscope to exactly half this reading, or just press the $\div 2$ button. You should again see a single image (which may be phase shifted with respect to the first image seen).

For example, when viewing a shaft with a single key way you will see one stationary image of the key way at the actual speed and at 1/2, 1/3, 1/4, etc.

of the actual speed. You will see 2 images of the key way at 2 times the actual speed, 3 key way at 3 times, etc. The FPM equals the shafts Revolutions Per Minute (RPM) at the highest flash rate that gives only one stationary image of the key way.

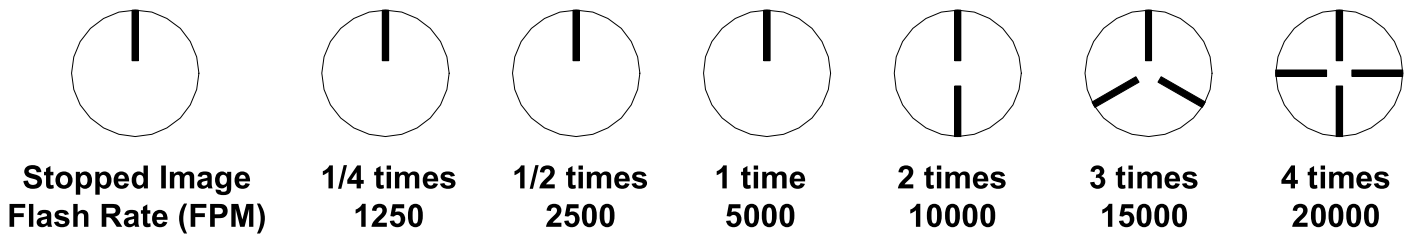

Example: Object rotating at 3000 RPM

If the speed is outside the full scale range of the stroboscope (300,000 FPM), it can be measured using the method of harmonics and multipoint calculation. Start at the highest flash rate and adjust the flash rate down. You will encounter multiple images so be aware of these. Note the flash rate of the first SINGLE image you encounter, call this speed “A”. Continue decreasing the flash rate until you encounter a second SINGLE image. Note this speed as “B”. Continue decreasing the speed until you reach a third SINGLE image at speed “C”.

For a two point calculation the actual speed is given by: $RPM = AB/(A-B)$

For a three point calculation: $RPM = 2XY(X+Y)/(X-Y)^2$ where
 $X = (A-B)$ and $Y = (B-C)$

If a Remote Optical Sensor or Magnetic Sensor is used to sense one pulse per revolution (External mode), the readout will display directly in RPM (FPM) without any adjustment required.

In instances when you can shut down the device and install a piece of reflective tape, then an optical tachometer is easier to use for RPM measurement. **Stroboscopes must be used when you can't shut down the device.** The human eye is not easily tricked into seeing a stopped image by a stroboscope when the flash rate is slower than 300 FPM. Therefore, stroboscopes are just about impossible to use below 300 FPM for inspection or to measure RPM.

8.0 BATTERIES

The Pocket LED Strobe is fitted with a rechargeable Lithium Ion battery pack. These batteries **are prone to self-discharge over time**. For maximum performance, charge the batteries prior to use and do not store in hot locations. The strobe uses an external charger. Allow 3-5 cycles of charging and discharging for batteries to reach full capacity. When not in use, the batteries should be charged at least every three months, otherwise the battery capacity will be reduced or the batteries may become unusable.

The enclosure contains control electronics to properly protect and safely charge the batteries. Never remove the batteries from the enclosure and attempt to charge externally. **Always use the charger supplied – LBC-U.**

5.1 Low Battery Indication

When the batteries are charged, there will be no battery icon indication. When the batteries are low, the Low Battery icon will appear in the display. The strobe may still be used for a short time.

Low Battery Icon =  Outline blinking (very little time left)

The strobe has a protection feature that prevents the strobe from operating if the battery voltage is too low. **This condition is indicated by no flash and the display shows “LO BAT”**. At this time the batteries must be recharged.

5.2 Charging the Batteries

The unit may be recharged at any time. You do not need to wait until the low battery condition is indicated.

To charge the strobe with the recharger:

1. Turn the strobe off.
2. Plug the Li-Ion charger cable into the recharger socket on the left of the keypad.
3. Plug the recharger into an AC mains wall outlet (115/230 Vac).

CAUTION: Use of rechargers other than the one supplied (Model LBC-U) will damage the stroboscope and void the warranty. **DO NOT LEAVE A CHARGER THAT IS NOT PLUGGED INTO THE AC POWER CONNECTED TO THE STROBE.**

When charging, the strobe will indicate *CHARGE* in the bottom right of the display when turned on and then it will shut off. The recharger will fast charge the batteries for about 4-5 hours and then trickle charge the batteries.

The charger has an LED to indicate charge: LED Red = batteries charging. LED Green = batteries charged or charger not connected.

The battery pack may be replaced by removing the battery cover and unplugging the battery pack. The new battery pack can be inserted and plugged into the unit. Replace the battery cover.

5.3 Stroboscope Disposal

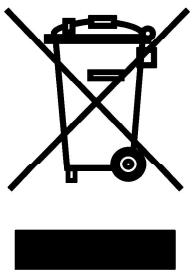

Prior to disposing of the battery-powered strobe, the user must remove the Lithium Ion batteries. To do this, remove the battery cover, unplug the battery pack and dispose according to local laws governing battery disposal. The rest of the parts may now be disposed of.

9.0 Specifications

Internal Mode:

Flash Range	30 to 300,000 FPM (Flashes Per Minute), 0.5 to 5000Hz
Flash Rate Accuracy	0.005% of setting or \pm last digit
Flash Rate Resolution	0.01 to 1 FPM (menu selectable), 0.1 FPM resolution above 9,999.99 FPM, 1 FPM resolution above 99,999.9
Display Update Rate	Instantaneous

External Modes:

Flash Range	0 to 300,000 FPM (Flashes Per Minute), 0 to 5000Hz
Tachometer Mode	30 to 300,000 RPM
Accuracy	\pm 0.005% of reading up to 250,000 or \pm last digit
Display Update Rate	0.5 second typical above 120 RPM
Trigger to Flash Delay	\sim 15 μ sec
External Input:	2.5V to 12V peak pulse 500 nanosec min pulse width, Positive or Negative edge triggered (menu selectable)
Output Pulse	3V pulse. One pulse per flash in internal mode. Mimics input pulse in external mode.
Pulse In to Out Delay	< 0.2 μ sec (External Mode)

General:

Time Base	Ultra Stable Crystal Oscillator
Display	LCD display with 6 numeric 0.506 inch [12.85 mm] high digits and 5 alphanumeric 0.282 inch [7.17 mm] high digits
Indicators	Low Battery, On Target, Select, TACH, and EXT icons
Memory	Last setting before power down is remembered and restored on next power up. 5 user settable memory locations

Flash Duration	Adjustable 0.5 to 1300 microseconds or 0.1 to 10 degrees of rotation (auto adjusts with flash rate)
Input Power	Battery powered: Internal Li-Ion Rechargeable Batteries 3.6Vdc
Light Output	Average: 3300 LUX @6000 FPM 12" from target @ 2°
Run Time	5 - 6 hours typical at 6000 FPM, and 2.8° pulse width with fully charged batteries
Charge Time	4-5 hours typical with supplied charge.
Weight	0.6 lbs [0.27 kg] including batteries
Safety	This product is designed to be safe for indoor use per IEC61010-1.
Operating Temperature	32 - 104 °F [0-40 °C]
Humidity	Maximum relative humidity 80% for temperature up to 88 °F [31 °C] decreasing linearly to 50% relative humidity at 104 °F [40 °C]
Compliance	CE compliant. Low Voltage Directive (LVD) 2014/35/EU Electromagnetic Compatibility Directive (EMC) 2014/30/EU Restriction of Hazardous Substances (RoHS) Directive 2011/65/EU
Energy Efficiency	This product complies with the U.S. Department of Energy's energy conservation standards specified in the Code of Federal Regulations 10 CFR 430.32(z) and is registered in the DoE CCMS database.



Product specifications subject to change without notice.

Manufactured in an ISO9001 facility.

10.0 SENSORS / ACCESSORIES and PARTS

Sensors / Accessories:

P/N	Model	Description
6180-029	ROLS-P	Remote Optical Laser Sensor with 8 foot [2.5 m] cable for triggering strobe
6180-081	RLS-P	Rugged Laser Sensor with removable cable
6180-057	ROS-P	Remote Optical Sensor with 8 foot [2.5 m] cable for triggering strobe
6180-057-25	ROS-P-25	Remote Optical Sensor with 25 foot [7.6 m] cable for triggering strobe
6280-073	Pouch	Protective carry pouch with belt loop
6280-072	CC-13	Plasctic latching carry case for Strobe with provision for accessories
6280-037	CA-4044-6	6 foot [1.8 m] Input / Output cable, 1/8" [3.5 mm] male stereo plug to male BNC connector
6180-070	T-5 Tape	Reflective tape - 5 foot [1.5 m] roll, 0.5 inch [12.7 mm] wide
6180-040	Mini Tripod	Miniature tripod with 1/4" x 20 threaded stud

Replacement Parts:

P/N	Model	Description
6280-027	LBC-U	Universal Li-Ion Recharger, 115/230 Vac with interchangeable plugs
6280-074	Li-Ion Battery Pack	Replacement Li-Ion Battery Pack

Check out some of our other product lines...



**Handheld
Tachometers**



**Panel
Tachometers**



**Portable
Stroboscopes**



**Machine Vision
Stroboscopes**



Speed Sensors



**Temperature/
Humidity Sensors**



Vibration Meters

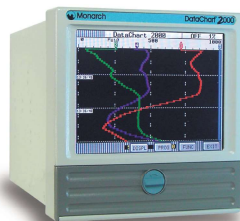
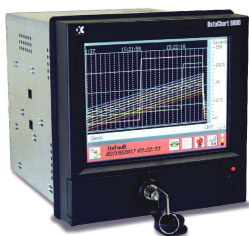

Paperless Recorders



Track-It™ Data Loggers

Printed in the U.S.A.

Copyright 2012-2019 Monarch Instrument, all rights reserved

1071-4235-115 - 1019

1.800.561.8187

www.**itm**.com

information@itm.com