

Instructions for Klein Tools Safety helmets

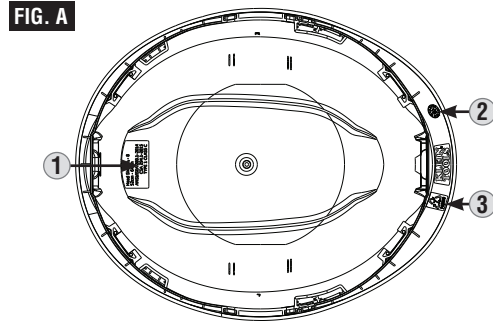
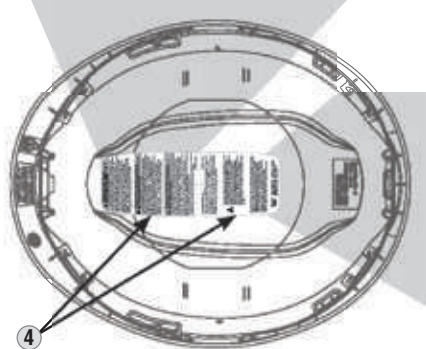

FIG. B

WARNING! BEFORE USE: READ ALL INSTRUCTIONS OR RISK SERIOUS INJURY OR DEATH. DO NOT REMOVE LABEL.

- This protective headwear is designed to absorb some of the energy of a blow through partial destruction of its component parts and, even though damage may not be readily apparent, any protective headwear subjected to severe impact should be replaced.
- This protective headwear must not be painted or cleaned with solvents. Any decals applied to the protective headwear must be compatible with the surface material and known not to affect adversely the characteristics of the materials used in the protective headwear.
- Any addition or structural modification may reduce the protective properties afforded by this protective headwear.



NOTE: This label is representative; contents will vary based on model #

FIG. C



FIG. D



FIG. E

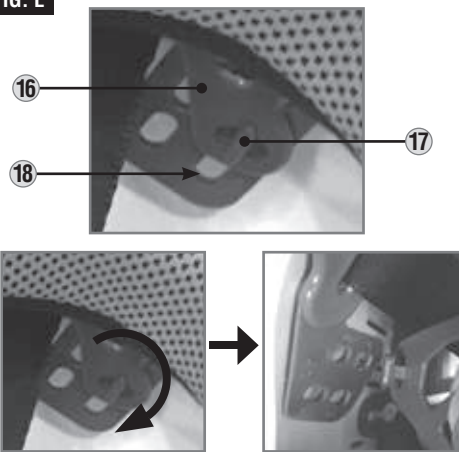

FIG. F1



FIG. F2

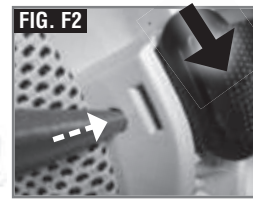

FIG. F3

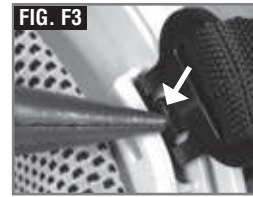

FIG. G

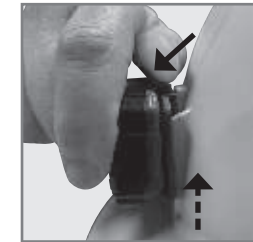
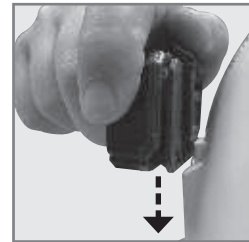
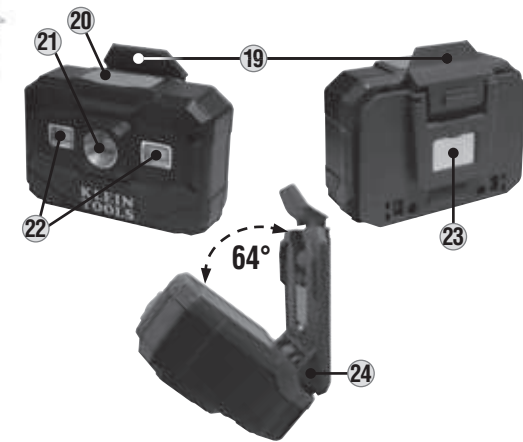
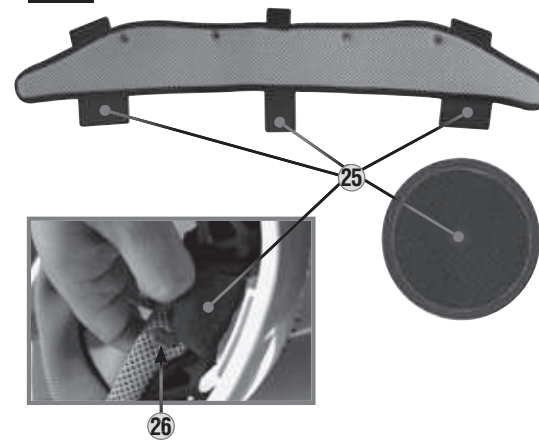

FIG. H



1370699 Rev. 1/20 A

This helmet provides LIMITED protection from small objects striking the top, front, back, left and right sides of the helmet. This is NOT an ANSI/CSA Type II helmet. NEVER use as a vehicular or sports helmet. Before using, replace any part showing wear or damage. Replace helmet after any impact. Never alter or apply paints or solvents. DO NOT expose safety helmet, suspension, padding, and chin strap to open flame. (See Instructions).

HEAD SIZE 6 1/2 - 8 (52cm - 64cm)

GENERAL SPECIFICATIONS

- **Standards:** These Klein Tools Safety Helmets comply with Type I ANSI/ISEA Z89.1-2014, CSA Z94.1-15:
- Class E non-vented Safety Helmets have been tested up to 20kV.
- EN397:2012+A1:2012 (Clauses listed only):
- 5.2.1 – Shock at Very Low Temperature
- 5.2.4 – Lateral Deformation (LD)
- 5.2.5 – Molten Metal Splash
- EN12492:2012 (Listed clauses only):
- 4.2.1.2 – Front Energy Absorption Capacity
- 4.2.1.3 – Side Energy Absorption Capacity
- 4.2.1.4 – Rear Energy Absorption Capacity
- 4.2.2 – Resistance To Penetration
- 4.2.3 – Retention System Strength
- 4.2.4 – Retention System Effectiveness (roll off)



- **Fits:** Head Sizes 6-1/2 to 8 (20-1/2 to 25 inches / 52 to 64 cm)

SYMBOLS ON PRODUCT (FIG. A)

- 1 Compliant Standards, Class, Type, and Head Size information
- 2 Date of manufacture
- 3 Recycling Code and material type

WARNING LABELS (FIG. B)

There are warning labels 4 affixed to the inside of this safety helmet. Read, understand, and follow these instructions to ensure safe operation. **DO NOT REMOVE THESE LABELS.**

⚠ WARNINGS

READ ALL INSTRUCTIONS. FAILURE TO FOLLOW THESE WARNINGS AND INSTRUCTIONS MAY RESULT IN SERIOUS BODILY INJURY OR DEATH.

- This safety helmet provides LIMITED protection from small objects striking top, front, back, left and right sides of the safety helmet. This is NOT an ANSI/CSA Type II helmet.
- **DO NOT** expose safety helmet, suspension, padding and chin strap to open flame.
- **ELECTRICAL WARNING:** Avoid areas where the chance of electrical shock exists. Non-vented versions meet Class E requirements by providing limited electrical protection. Class C vented models provide no electrical protection. (See WARNING LABELS Section).
- If the safety helmet has sustained an impact, dispose of it IMMEDIATELY, even if damage is not visible.
- **NEVER** alter, puncture, modify or engrave the shell, suspension or chin strap.
- **DO NOT** use paints, solvents, chemicals, adhesives, gasoline or like substances on this safety helmet – doing so can lessen the protection offered against impact and penetration.
- **DO NOT** use this safety helmet as a vehicular or recreational safety helmet.
- **DO NOT** store objects between the suspension and the shell, as the safety helmet will not function as intended and can lessen the protection from impact and penetration.
- Exposure to direct sunlight, corrosive environments, and/or extreme temperatures below -40°F (-40°C) or above 120°F (49°C) can lessen the ability of the safety helmet to withstand impact and penetration.

MAINTENANCE

SAFETY HELMET CLEANING AND STORAGE

- Clean the safety helmet and suspension with mild soap and water only. Rinse and wipe dry. Clean chin strap with damp cloth only. Store in a cool place.
- See SWEATBAND AND TOP COMFORT PAD section of the operating instructions (on other side) for additional maintenance information.

INSPECTION AND REPLACEMENT

- Inspect the safety helmet, including the suspension, chin strap and shell, before and after each use:
- Check the Safety helmet's shell for any cracks, breakage, discoloration, chalky appearance, or any other damage, excessive wear or unusual condition. These conditions may indicate reduced impact or penetration resistance and the Safety helmet must be replaced IMMEDIATELY.
- The suspension and chin strap should be checked for cracks, breaks, damaged stitching or any other damage, excessive wear or unusual condition. If any of these conditions exist, they must be replaced IMMEDIATELY.
- Always use genuine Klein Tools replacement parts. This product works as a system, and use of unauthorized suspensions and chin straps may reduce the protection you receive from this safety helmet.

USEFUL LIFE

SUSPENSION AND CHIN STRAP: Must be replaced after no more than 12 months of use.

ENTIRE SAFETY HELMET: Entire Safety helmet should be replaced after 2 years of use, or no more than 5 years from the date of manufacture, whichever comes first.

These are useful service life guidelines. Regular inspection as detailed in the MAINTENANCE section above MUST be performed, and may result in possible earlier replacement.

NOTE: This replacement schedule is a guideline that assumes normal use and storage conditions for the safety helmet. If the safety helmet is exposed to temperature extremes, persistent sunlight, or chemicals, replacement may be required in a shorter time frame.

WARRANTY

www.kleintools.com/warranty

ACCESSORIES AND REPLACEMENT PARTS

Klein Tools safety helmet accessories and replacement parts are available online or at major distributors:

- CLMBRSPN: Replacement 6-Point Suspension
- KHHSWTBND: Sweatband (3-pack)
- KHHTOPPAD: Top Comfort Pad (3-pack)
- CLMBRSTRP: Replacement Chin Strap
- 56034: Rechargeable Auto-Off Headlamp (Spot/Flood)
- 56049: Rechargeable Light Array Headlamp (Flood only)
- 56062: Rechargeable Headlamp / Worklight (Spot/Flood)
- 56048: Rechargeable Auto-Off Headlamp (Spot/Flood)
- KHH56220: Headlamp / Magnetic Worklight (Spot/Flood)
- VISORCLR: Clear Visor
- VISORGRAY: Tinted Gray Visor

NOTE: KLEIN TOOLS CANNOT GUARANTEE THAT THIRD-PARTY ACCESSORIES WILL PERFORM OR FIT OPTIMALLY WITH KLEIN TOOLS SAFETY HELMETS.

DISPOSAL / RECYCLE



Do not place safety helmet or its accessories in the trash. Items must be properly disposed of in accordance with local regulations. See www.epa.gov for additional information.

FEATURE DETAILS (FIG. C)

- | | |
|-------------------------------------|---------------------------------|
| 5 Universal accessory slots | 12 Washable sweatband |
| 6 Klein Tools accessory slots | 13 Washable top comfort pad |
| 7 Vents with shutter (Class C only) | 14 Suspension straps |
| 8 Pivot adjustment | 15 Reflective sticker locations |
| 9 Size adjustment knob | 16 Suspension bracket |
| 10 Rear neck pad | 17 Bracket key |
| 11 Suspension strap anchor slots | 18 Bracket key slots |

FITTING (FIG. D)

All safety helmets come with suspension pre-installed at factory settings. The suspension can be adjusted to ensure proper and secure fit to your head for maximum protection. Follow the steps below:

- STEP 1:** Turn the size adjustment knob 9 counterclockwise to loosen the fit. Position the rear pad on the back of your head, closer to the neck. Dress any bandana knots or ponytails over the rear neck pad 10.
- STEP 2:** Tighten by turning the size adjustment knob 9 clockwise until the safety helmet is comfortable and snug. Move your head up, down and side-to-side gently, like you would normally, and make sure the safety helmet stays on. Make sure that the safety helmet is not angled forward or backward, but rests level on your head.

SUSPENSION ADJUSTMENT (FIG. E)

If the safety helmet does not fit properly at the factory settings, you can further adjust the fit.

- STEP 1:** Free the suspension by turning the suspension bracket 16 approximately 90 degrees to free the bracket key 17 from the bracket key slots 18.
- STEP 2:** Determine which slot 18 you want to reattach to. Using the bracket slots deeper in the safety helmet will move it higher on the head and vice versa. Insert the bracket key 17 and turn the bracket 16 approximately 90 degrees to lock into place. Always match the settings on the left and right sides to prevent the suspension from sitting at an angle.

SUSPENSION ADJUSTMENT (FIG. E)

STEP 3: Verify the safety helmet fits properly. Follow the steps in the FITTING section to ensure proper fit. Ensure that accessories you plan to use fit and function properly while maintaining the safety helmet's ability to perform its function optimally. Check with a qualified safety expert, if unsure.

NOTE: The suspension strap lengths are fixed and cannot be adjusted. DO NOT attempt to alter.

CHIN STRAP ADJUSTMENT / REMOVAL (FIG. F1, F2, F3)

The safety helmet comes with the chin strap pre-installed.

TO ADJUST CHIN STRAP:

STEP 1: Close the chin strap, adjust the leather portion of the strap through the clasp loop. Try on the safety helmet and readjust until the strap is snug between your chin and neck.

STEP 2: Adjust both side "V" brackets up or down for final adjustment. Ensure both sides of the "V" straps are even, as shown in FIG. F1.

TO REMOVE CHIN STRAP:

STEP 1: Insert a small blunt-nosed tool (such as long-nosed pliers) into the round opening to press the release tab as shown in FIG. F2.

STEP 2: Gently pull the strap to begin removing the tab from the slot. The tab will not come out completely in this step. Once the tab catches, stop pulling. **DO NOT attempt to forcefully remove.**

STEP 3: Press the exposed portion of the release tab as shown in FIG. F3 while gently pulling on the strap to release the tab from the slot. Repeat process at all remaining attachment points.

NOTE: Check with your Safety Supervisor prior to removing your chin strap, as it may be required at all times on your jobsite.

SWEATBAND AND TOP COMFORT PAD (FIG. H)

Klein Tools safety helmets come with an advanced sweatband and top comfort pad designed to wick away sweat. They are machine washable in a normal wash cycle. **DO NOT** wash with bleach or with detergents containing bleach. Machine dry on normal or low heat setting only.

The sweatband and top comfort pad can be easily removed and reinstalled on the suspension:

- The top comfort pad is held in place by a single hook-and-loop pad 25.
- The sweatband is held in place by four suspension hooks 26 and three hook-and-loop pads 25, on the side and front. To remove, simply detach all hook-and-loop pads and slide the sweatband off the suspension hooks.

VENTS (C-CLASS ONLY)

Klein Tools Class C safety helmets have vents and shutters on both sides. The vents can be adjusted by simply sliding the shutter tabs 7 up or down.

⚠ The vents and shutters will NOT prevent vapors, liquids, or debris smaller than the vents from entering the safety helmet.

56062 HEADLAMP (FIG. G)

The optional 56062 is a rechargeable headlamp designed specifically for Klein safety helmets that have the integrated front and rear accessory slots. It functions as a spot light or flood light, and has magnet to attach onto magnetic surfaces for use as a worklight. Charging cable is included with models that include rechargeable headlamps.

- | | |
|-----------------------|-------------------|
| 19 Release tab | 22 Flood lights |
| 20 On/Off/Mode button | 23 Magnet |
| 21 Spot light | 24 Pivoting mount |

The 56062 can be attached to both the front and back of the helmet via the Klein Tools accessory slot. It can be tilted up to 64 degrees on the safety helmet and standalone as a worklight.

To install the headlamp onto a Klein safety helmet, align the pivoting mount 24 with the Klein Tools accessory slot 6 on the safety helmet and push down until the headlamp clicks securely into place.

To remove the headlamp, press forward on the Release Tab 19, and lift the headlamp out of the accessory slot.

REFLECTIVE STICKERS (FIG. C)

Klein Tools safety helmets come with four optional reflective stickers. For optimal performance, affix only to the designated areas 15. **DO NOT** apply stickers in areas that will impede the functionality of accessories or of the safety helmet itself.

VISORS

Optional visors specially designed to mount 27 onto Klein Tools Safety Helmets are also available, in clear and tinted gray. See **ACCESSORIES AND REPLACEMENT PARTS** section for available models.