

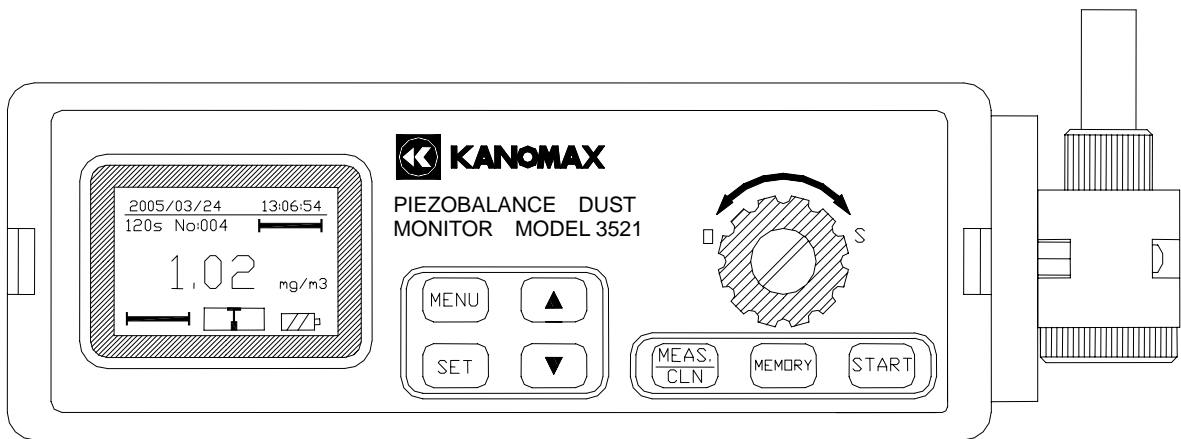

Piezobalance Dust Monitor

MODEL 3521

Operation Manual





Read this manual carefully and understand the warnings before operating the instrument.
Keep this manual handy for future reference.





Important Safety Information



Types and definitions of warning signs used in this operation manual are shown below.



 **Danger:** To prevent serious injury or death.
Items under this heading show measures to prevent serious injury or death, which may result if the instructions in this manual are not observed and the instrument is operated inappropriately.









 **Caution:** To prevent damage to the product.
Items under this heading show measures to prevent damage to the product and conditions that affect the product warranty.

[Description of Symbols]

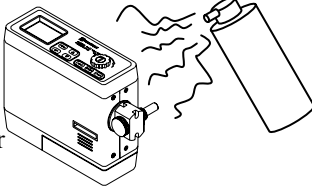
  This symbol indicates a condition (including danger) that requires caution. The subject of each caution is illustrated inside the triangle (e.g., the high temperature caution symbol shown on the left).

  This symbol indicates a prohibition. Do not take the prohibited action shown inside or near this symbol (e.g., the do not disassemble symbol is shown on the left).

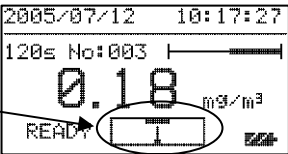
  This symbol indicates a mandatory action. A specific action is given near the symbol.

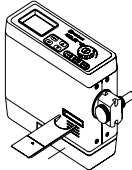
 Danger			
* Never expose the instrument to flammable gas.			
Do not use near flammable gas.			
* Never disassemble, heat, or discard the battery pack in fire.			
..... The battery pack may explode.	Explosive	Handle Properly	
* Never perform the cleaning procedure with the instrument set to high voltage (if the high-voltage is active, the pointer will be located at the center of the indicator.)			
		Prohibition	
Performing cleaning while the high-voltage is active may cause an electrical shock			

 Caution

*** Do not drop or strike the instrument.**

..... Dropping or hitting the instrument may cause damage or a malfunction.



Prohibition

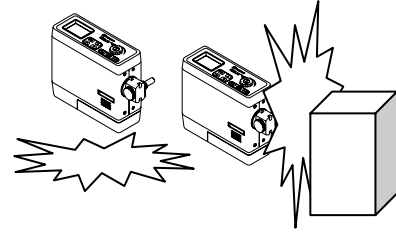

*** Never disassemble, modify or repair the instrument.**

..... Failure to observe the above may cause a short circuit or a malfunction.



Do not modify / disassemble

*** Do not block the impactor inlet.**

..... Failure to observe the above may cause a pump failure.



Prohibition

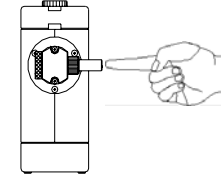

*** Do not perform a measurement in an environment with extreme temperature or humidity changes.**

..... Using the instrument in an environment with extreme temperature or humidity changes may cause an error in the measurement value.
The allowable rate of change during a 2 minute measurement is:
Temperature: $\pm 1^{\circ}\text{C}$ (0°C to 40°C), Humidity: $\pm 1\%\text{RH}$ ($30\%\text{RH}$ to $80\%\text{RH}$).



Handle Properly

*** Do not wipe the instrument with a volatile solvent.**

..... The body may deform or deteriorate. Use soft dry cloth to remove stains.
If stains persist, dampen the cloth in a neutral detergent and wipe the instrument.
Do not use volatile solvents such as thinner or benzene.



Prohibition

*** Make sure there is no turbulent air flow near the sampling inlet.**

..... Turbulent air flow may cause a measurement error.



Handle Properly

*** Do not clean the instrument in an environment where the temperature is below 0°C .**

..... The cleaning sponge may freeze and cause damage to the sensor.



Prohibition

Table of Contents

- 1. Part Names and Functions 1**
 - 1.1 Part Names 1
 - 1.2 LCD Screen 2
 - 1.3 Operation Keys 2
- 2. Battery Indicator..... 3**
- 3. Battery Charge 4**
 - 3.1 AC/DC Adapter..... 4
 - 3.2 Battery Charging Display 4
- 4. Parts Installation and Measurement Preparation 5**
 - 4.1 Removal and Installation of the Rechargeable Battery Pack 5
 - 4.2 Accessing and Storing the Cleaning Device 6
 - 4.3 Confirming the Sensor Condition 7
 - 4.4 Cleaning the Sponge 8
 - 4.5 Cleaning the Sensor 9
 - 4.6 Adjusting the Impactor Position 10
 - 4.7 Sampling Time..... 10
- 5. Measurement Method..... 11**
 - 5.1 High Voltage Supply 11
 - 5.2 Measurement Start 12
 - 5.3 Measurement End 13
- 6. Settings Menu 14**
 - 6.1 Main Menu 14
 - 6.2 Sampling Time Menu 14
 - 6.3 Data Output Menu 15
 - 6.4 Time Adjustment Menu 15
 - 6.5 Communications Menu 16
 - 6.6 Data Clear Menu..... 17
- 7. Printing 18**
 - 7.1 Connecting the Printer 18
 - 7.2 Print Output Menu 18
- 8. Regular Maintenance and Impactor Nozzle Replacement..... 19**
 - 8.1 Impactor Cleaning 19
 - 8.2 Removing and Cleaning the Needle 20
 - 8.3 Installing the Needle 20
 - 8.3 Installing the Needle 21
 - 8.4 Replacing the Impactor Nozzle 21

- 10. Troubleshooting.....23
- 11. Warranty and After-sales Service24
- 12. Contact Information26

1. Part Names and Functions

1.1 Part Names

(unit: mm (inches))

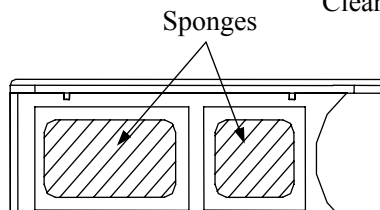
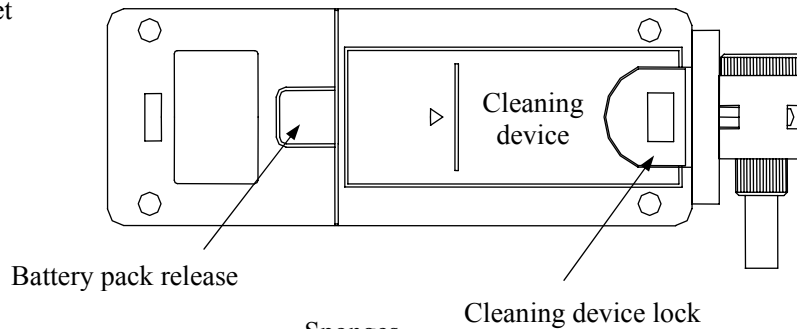
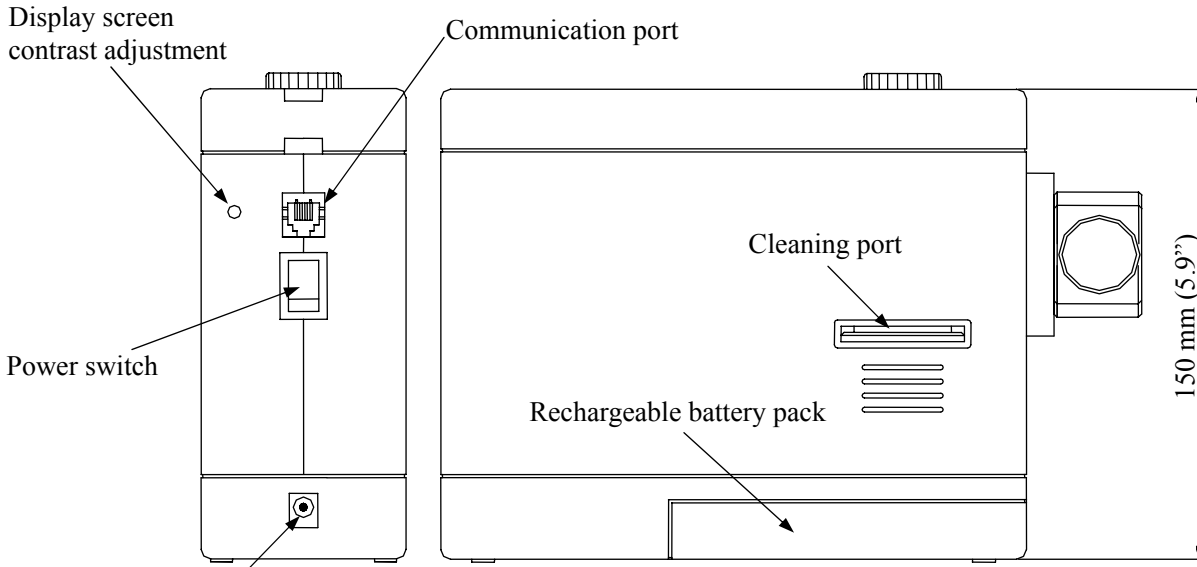
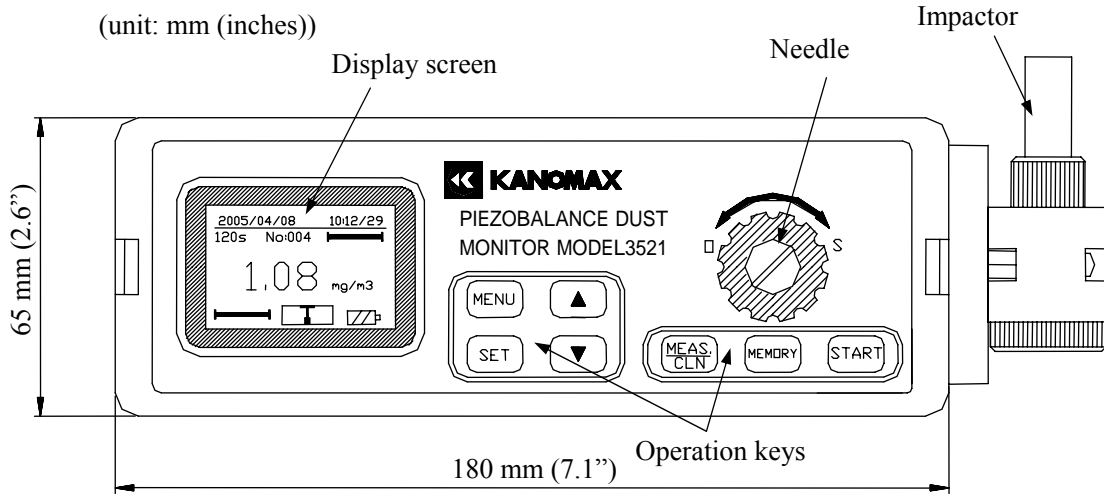

1.2 LCD Screen

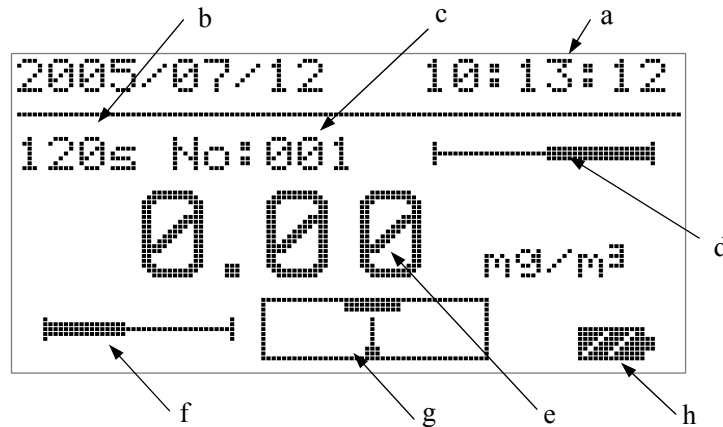

- a. Date & Time:**
Indicates current date & time.
- b. Sampling Time:**
Sampling time can be quick set to either 24s, 120s or custom set from 1-60 min.
- c. Data Record:**
Indicates the current number of data records (Max.500). When a measurement is complete, “STORE” will flash here. To save the data, press [MEMORY].
- d. Measurable Range:**
The remaining measurable range is indicated by a bar indicator, which moves from left to right as the sensor absorbs dust and the range decreases. When the sampled dust exceeds approx. 10 μ g (>Fundamental Frequency + 2000 Hz), “CLEANING” will flash here. The cleaning procedure must be performed when the remaining measurable range is too small or if “CLEANING” flashes.
- e. Concentration Reading:**
The concentration reading flashes during a measuring.
- f. Operating Status:**
“WAIT” flashes during cleaning and power-up.
“READY” flashes when high voltage is supplied and the instrument is ready for a measurement.
The remaining sampling time is displayed during a measurement. The indicator bar increases from left to right as time elapses.
- g. High Voltage Indicator:**
The high voltage status indicator displays when high voltage is being supplied. When the pointer moves to the center of the frame (under the black block), the operating status changes to “READY”, and the instrument is ready to perform a measurement.
- h. Battery Indicator:**
Indicates remaining battery power.

1.3 Operation Keys

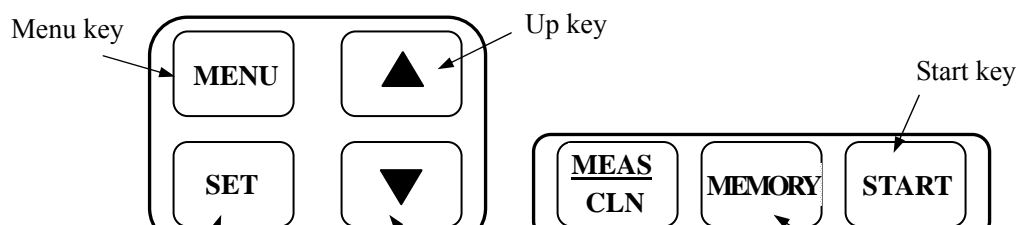

2. Battery Indicator

Remaining battery life is displayed when the instrument is powered on.
The battery indicator changes as shown below:

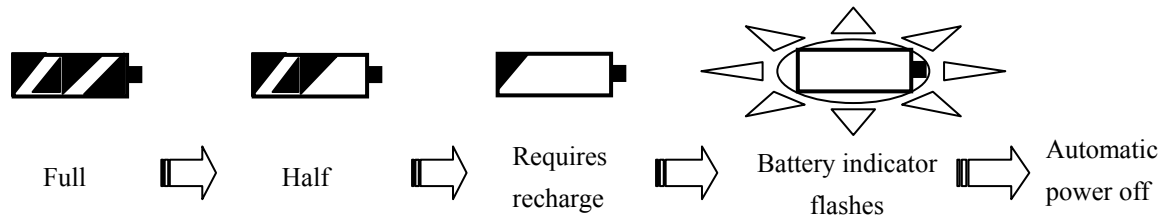

- The battery indicator flashes when the battery voltage drops below 9.3V. The AC/DC adapter must be connected immediately to continue measuring.
- If the adapter is not connected, the instrument will power off automatically.

3. Battery Charge

3.1 AC/DC Adapter

For prolonged measurements, the instrument should be powered using the supplied AC/DC adapter (when AC100-240V power is available). Insert the adapter jack into the adapter socket on the instrument first, and then to a power outlet.

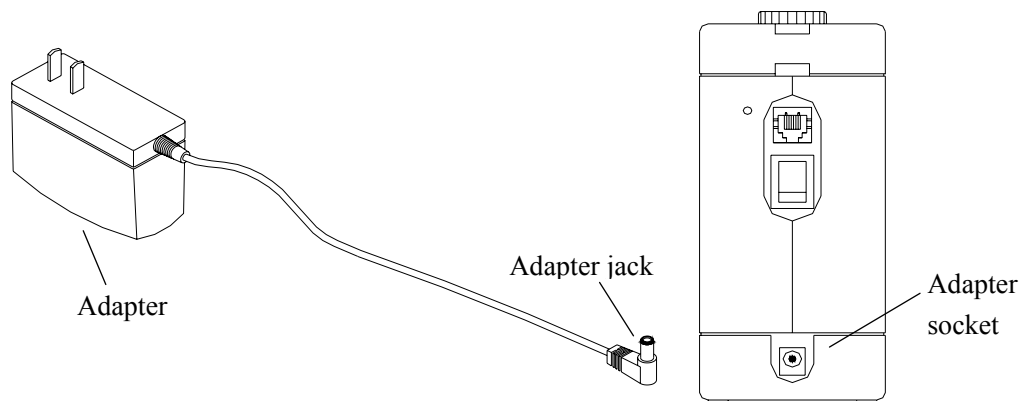

When AC power is supplied, the battery charging status bar will display on the screen. While the battery is being charged, the bar indicator will move. When it is fully charged, the bar indicator will stop moving.

3.2 Battery Charging Display

The battery can be recharged while the instrument is turned ON or OFF. The bar indicator shown on the right indicates the battery is charging.

When the battery is fully charged, as shown on the right, unplug the adapter.

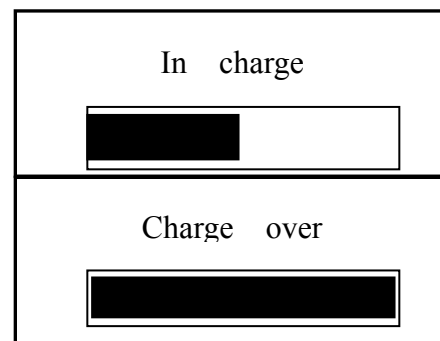

- 1) **Caution:** The input of the AC/DC adapter is AC 100-240V and the output is DC 12.5V. Do not use an adapter other than the one supplied with the instrument. Using the wrong adapter may cause a charging failure or damage the instrument.
- 2) The estimated continuous operating time using the rechargeable Ni-MH battery is approx. 4.5 hours. Charging time is approx. 5-8 hours.
- 3) If the instrument is not going to be used for an extended period, the battery should be charged once a month in order to extend the service life of the battery.
- 4) The instrument can be operated using the AC adapter or battery power. If the adapter is connected to the instrument a measurement can be performed simply by turning on the power. If the instrument is going to be operated under battery power it is recommended that the battery be fully charged before starting a measurement.
- 5) Turn off the instrument when it is not in use. Unplug the adapter when the device is not in use and the batteries are not charging.

4. Parts Installation and Measurement Preparation

4.1 Removal and Installation of the Rechargeable Battery Pack

- 1) Press the rechargeable battery pack release, and slide the battery pack along the guiding groove away from the release as shown below.

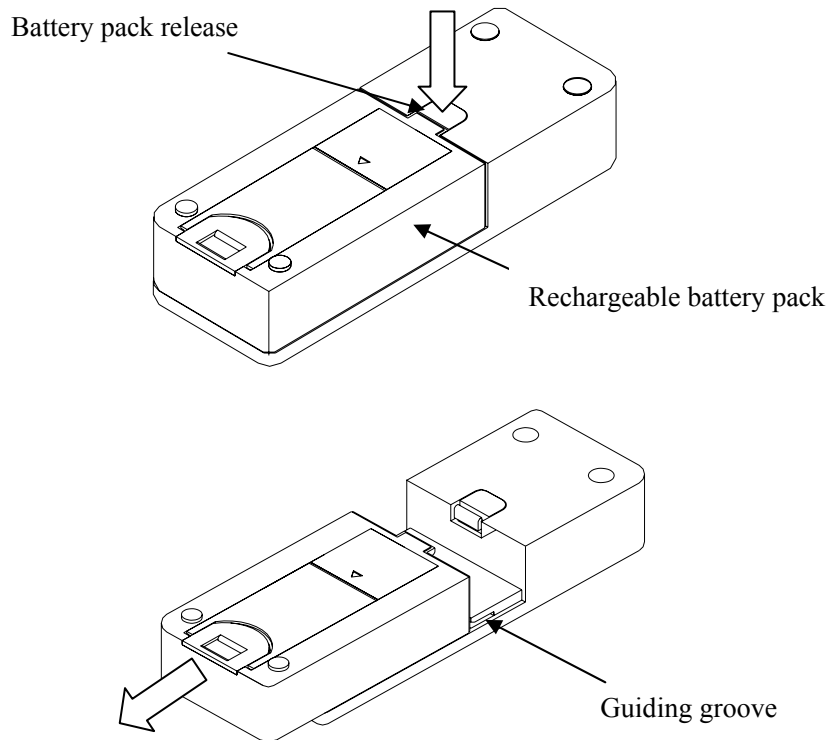

- 2) Align the tabs on the rechargeable battery pack with the slots in the guiding groove and lift the battery pack free from the instrument.

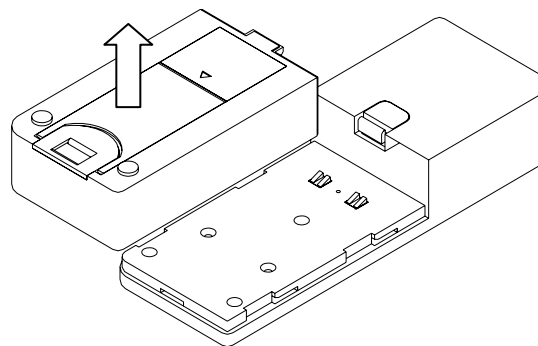

- 3) To reinstall the battery pack, reverse the above procedure.

4.2 Accessing and Storing the Cleaning Device

- 1) To access the cleaning device, hold the cleaning device while sliding the lock away from the cleaning device as shown below.

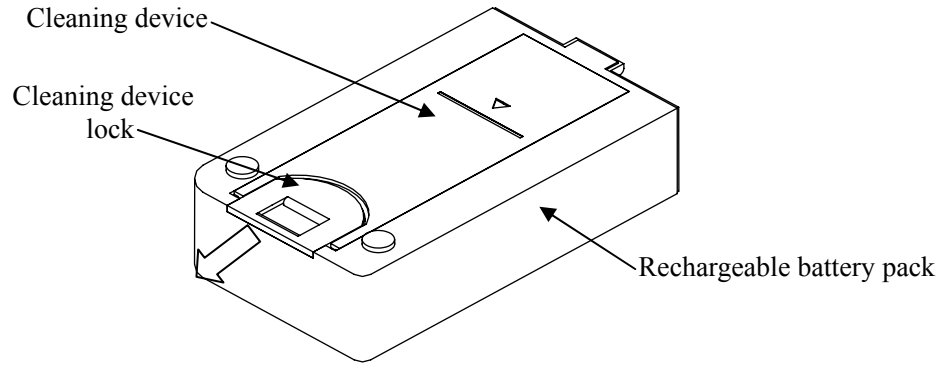

- 2) After the lock is released, remove the cleaning device by lifting the front end.

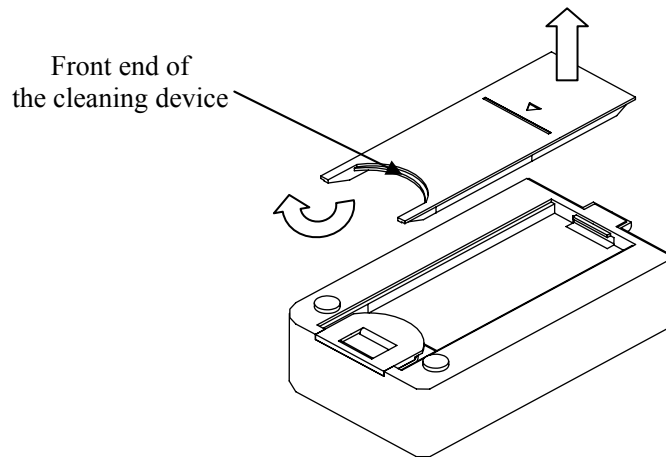

- 3) To return the cleaning device to storage, place the rear end of the cleaning device onto the battery pack first, and then push the front end of the cleaning device into the locker. After the cleaning device is in place, push the lock to its original position to secure it.

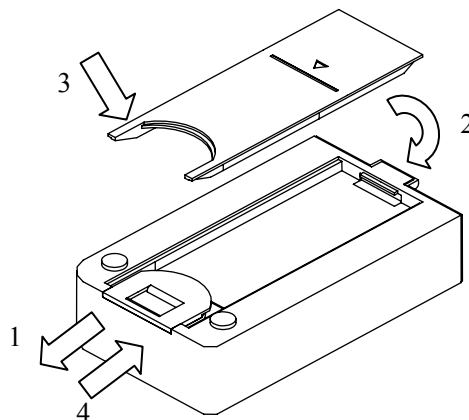

4.3 Confirming the Sensor Condition

When the instrument is powered on, the screen below will display a flashing “WAIT” message in the operating status field. After approx. 10 seconds the sensor will stabilize and the “WAIT” message will stop flashing.

The measurable range of the sensor can be confirmed by the bar indicator and the frequency displayed on the screen.

1) **Confirming the Measurable Range using the Bar Indicator:**

The bar indicator will be at full length immediately after cleaning. The bar will move to the right, decreasing in length as dust accumulates on the sensor. When the remaining length of the bar indicator is short, or when “CLEANING” is flashing, the sensor should be cleaned immediately. (Refer to section 4.4 and 4.5 for cleaning.)

2) **Confirming the Measurable Range using the Frequency display:**

The frequency can be displayed by pressing or , and hidden by pressing or again.

The frequency will increase as dust accumulates on the sensor. When the frequency exceeds the Fundamental Frequency + 2000Hz, “CLEANING” will flash. Cleaning should be done immediately.

* The frequency increases as the length of the measurable range bar indicator decreases.

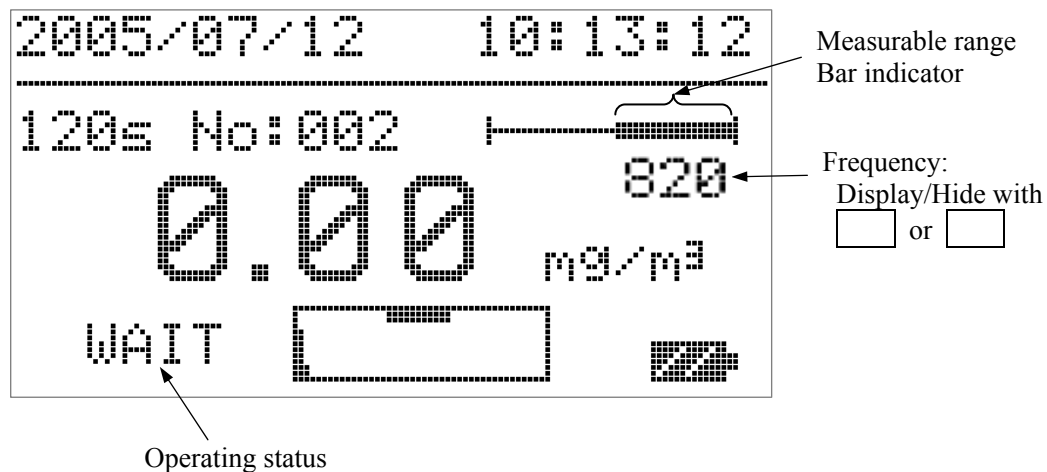

Caution:

Confirm that the bar indicator has sufficient length before starting a measurement. Never leave dust accumulated on the sensor as it may prevent the bar indicator from recovering even after cleaning. It can also affect the frequency display, which will affect the measurement accuracy.

4.4 Cleaning the Sponge

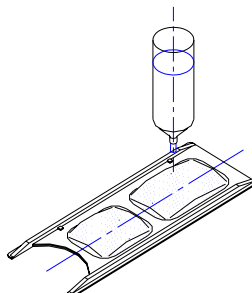
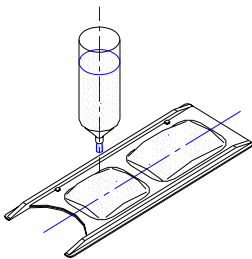
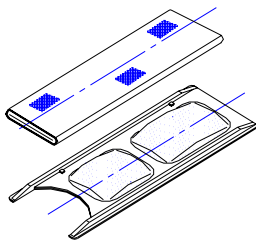
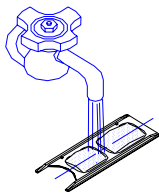
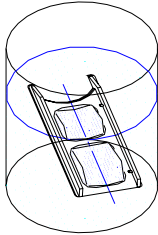

Preparation Before Cleaning

- 1) The sponge on the cleaning device must be moistened before use. If the sponge is dirty or stained, put the cleaning device into a vessel filled with clean water and a few drops of neutral detergent, and let it soak for a few minutes (this is not necessary for a new product).
- 2) When the stain is removed, rinse the sponge under running water making sure to completely remove all the detergent.
- 3) Use a folded tissue or paper towel to remove all excess water from the sponge. Repeat this process several times to ensure the removal of all moisture.
- 4) Put 1-2 drops of the provided detergent (blue) on the SMALLER sponge.
- 5) Put 2-3 drops of purified water on the LARGER sponge.

Caution:

- 1) Note that the two sponges differ in size. 1-2 drops of detergent go on the smaller sponge. Only purified water goes on the larger sponge.
- 2) If the sponge is dirty or stained with oil that cannot be removed by washing it in clean water, put the cleaning device into a vessel filled with clean water and 3-4 drops of neutral detergent. After the stain is removed, rinse the sponge under running water.
- 3) If the stain cannot be removed from the sponge or if the sponge is damaged, it must be discarded. Please contact your local distributor or our service center to purchase a new sponge.
- 4) Any water droplets remaining on the cleaning device other than the sponge itself must be removed completely using a folded tissue or paper towel. If water drops are left on the cleaning device when it is inserted into the instrument, the drops may attach to the sensor or needle, causing a recovery failure of the measurable range or failure when applying high voltage.
- 5) Using an excessively moist sponge could lead to a prolonged drying time. In addition, the instrument reading may become unstable, and the “WAIT” message may not be displayed.
- 6) Do not use a detergent other than the one provided. Using other detergents may result in an oily film or accumulation of sediment on the sensor, which will affect measurements.

4.5 Cleaning the Sensor

First, confirm that the high voltage is turned off. Then align the front end of the cleaning device with the cleaning port, and slowly insert the cleaning device with the sponge side facing down. The cleaning device must be inserted up to the scale line indicated on the back side of the cleaning device. When the scale line is flush with the port, stop and wait for approximately 20 seconds. Then, insert the cleaning device further, and pull it out from the other side. The sensor will then be drying, and a flashing “WAIT” message will be displayed on the screen. Approximately 3 minutes is required for drying. When the sensor is dried, the “WAIT” message will stop flashing. The bar indicator of the measurable range should return to the initial position. If the indicator is not returned to its initial position, the above cleaning process must be repeated again as there may be dust remaining on the sensor.

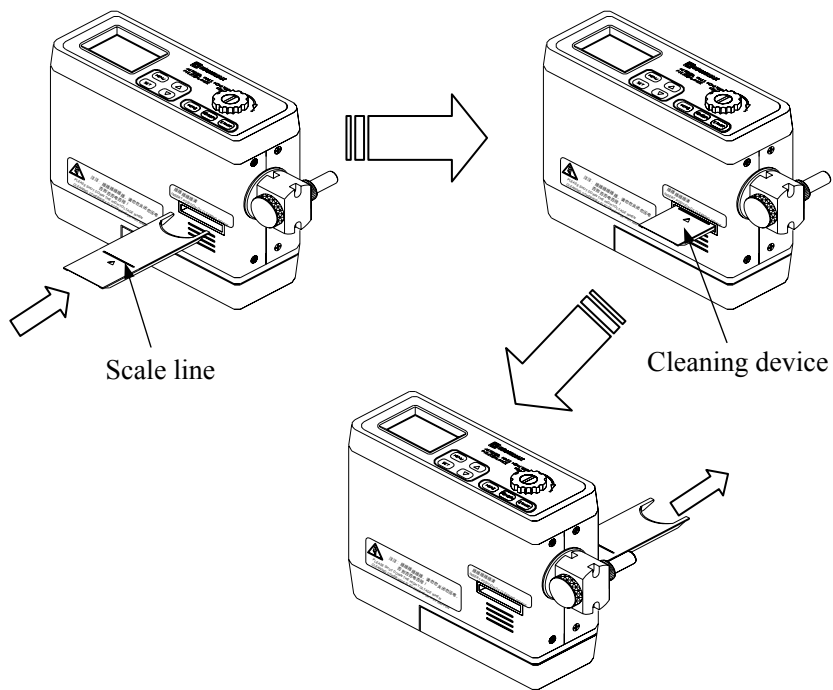

Caution:

- 1) Ensure that the high voltage is turned off before cleaning the sensor.
Residual high voltage is not fully discharged right after power off. Before starting cleaning, confirm that the pointer of the high voltage indicator is at the left end of the display.
- 2) When the sensor is cleaned, the flashing “WAIT” message will be displayed. During this period, high voltage cannot be supplied even if the [MEAS] is pressed. This is not a malfunction. When the sensor is dried, the “WAIT” message will stop flashing. Excess moisture on the cleaning device could lead to a prolonged drying time. If it is taking a long time for the sensor to dry, absorb the moisture on the sponge with a folded tissue or paper towel and repeat the cleaning procedure with the drier sponge.
- 3) Do not force the cleaning device in if the sponge is torn or protruding from the cleaning device. Forcing the cleaning device could apply excessive pressure to the sensor causing damage.
- 4) Using a dirty sponge could prevent the measurable range indicator from returning to its initial position. Ensure that the sponge is clean before performing a sensor cleaning.
- 5) Do not perform a sensor cleaning if the ambient temperature is below freezing.

4.6 Adjusting the Impactor Position

The impactor may be set at three angles: 0°, 45° and 90°. Turn the impactor to the desired angle. (Note: The instrument has built in stops for each angle.)

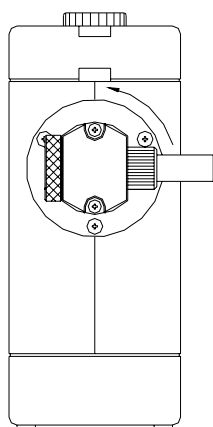

Rotation angle: 0°

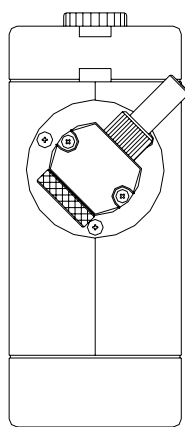

Rotation angle: 45°

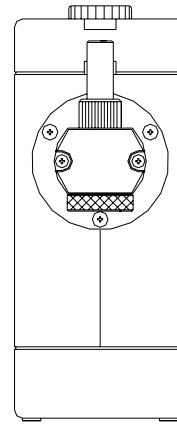

Rotation angle: 90°

4.7 Sampling Time

For instructions on how to set the sampling time, see Section 6. Settings Menu.

The initial setting of the sampling mode is 120s. Change the setting according to the dust concentration of the environment to be measured. When performing measurements in a high concentration environment, such as a work environment, select 24s. For indoor measurement in a low concentration environment, select 120s. For measurements in a high concentration environment, the cleaning frequency can be reduced by setting a short sampling time. For measurements in a low concentration environment, the measurement accuracy can be increased by extending the sampling time.

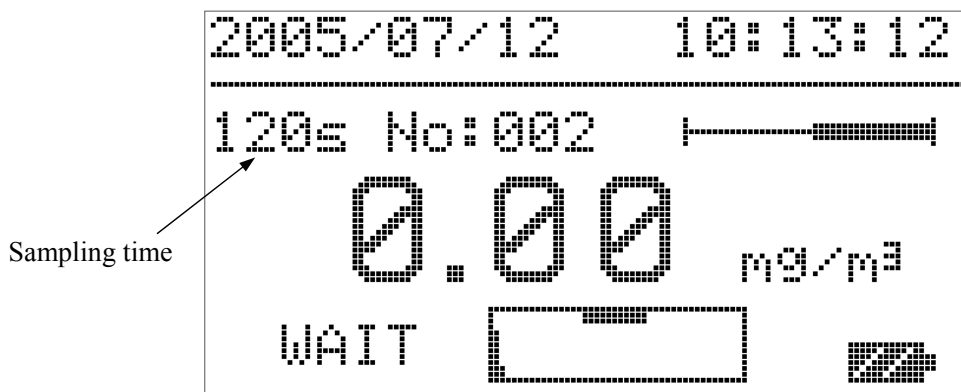

5. Measurement Method

5.1 High Voltage Supply

When the instrument is turned on, the flashing “WAIT” message will be displayed. After a brief delay, the “WAIT” message will stop flashing, and high voltage can be supplied. Press [MEAS/CLN] to supply high voltage. The pointer at the left end of the high-voltage indicator frame will move toward the right. The pointer will stop at the center of the frame under the black block. When the sensor becomes stable, the operating status will change from “WAIT” to “READY” and the instrument will be ready for measurement.

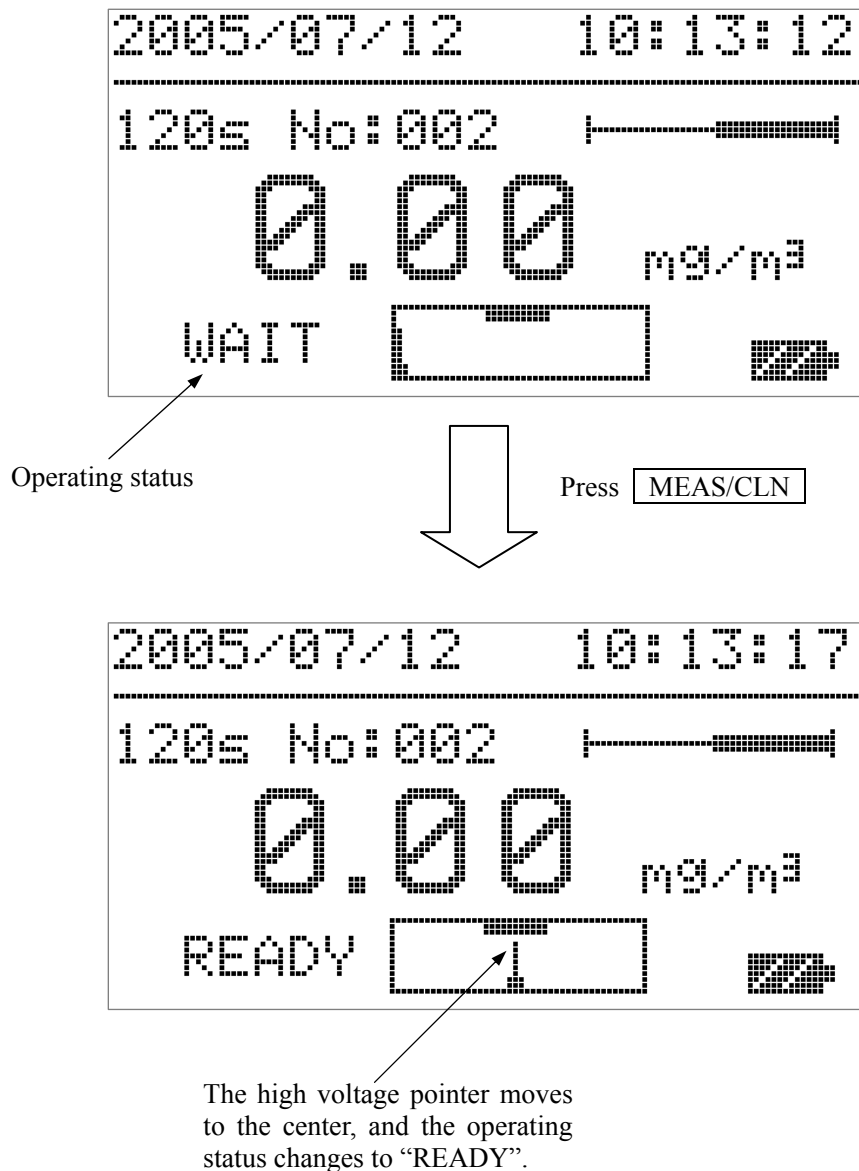

5.2 Measurement Start

To start a measurement, press [START] after the operating status has changed to “READY”. The “READY” message will change to an elapsed time indicator. During the measurement, the bar indicator will extend as time elapses and the concentration reading will blink. The measurement will stop automatically when the set time has elapsed. The reading will stop flashing and the final concentration value will be displayed.

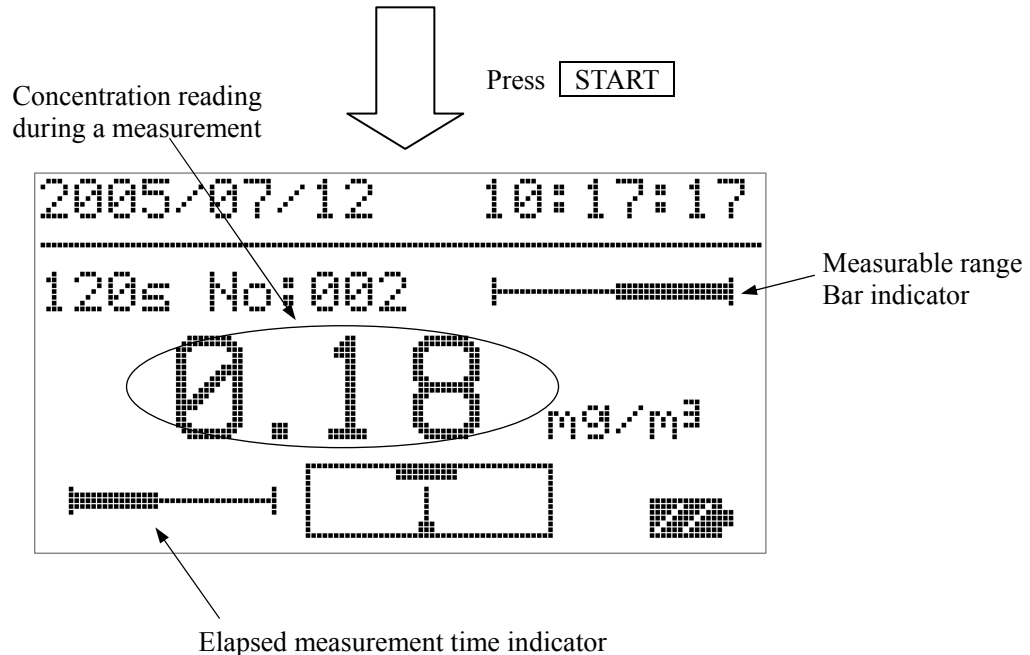

Note:

- 1) When [START] is pressed during a measurement, the measurement will stop and the concentration reading will change to “-.-”.
- 2) When [MEAS/CLN] is pressed during a measurement, the measurement and the high voltage supply will stop and the concentration reading will change to “-.-”. This procedure provides an emergency stop during a measurement.
- 3) If the dust sampled during a measurement exceeds the measurable range, the measurable range indicator will change to a flashing “CLEANING” message. If a sampling time of 24s or 120s was selected, the measurement will continue. After the measurement is complete, the high-voltage supply will stop automatically to prevent further measurement. Perform a sensor cleaning to restore the instrument to a measurable condition. If an arbitrary sampling time was set using TSET, then the measurement will stop immediately if the measurable range is exceeded. The data sampled up to that point will not be saved in this case.
- 4) The reading of 0.00mg/m^3 will be flashing for 5 seconds after starting a measurement. This is because the reading is updated every 5 seconds.

5.3 Measurement End

When a measurement is complete, the concentration reading will stop flashing. The displayed value is the measurement result for the specified sampling time. The operating status display will change from the elapsed time indicator to the “READY” message, and the number of data records will change to a flashing “STORE” message. If you want to save the measurement result, press [MEMORY]. Ignore the message if you do not want to save the result.

To start another measurement, press [START].

If you are finished measuring, press [MEAS/CLN] to stop the high voltage supply. Then, turn off the power.

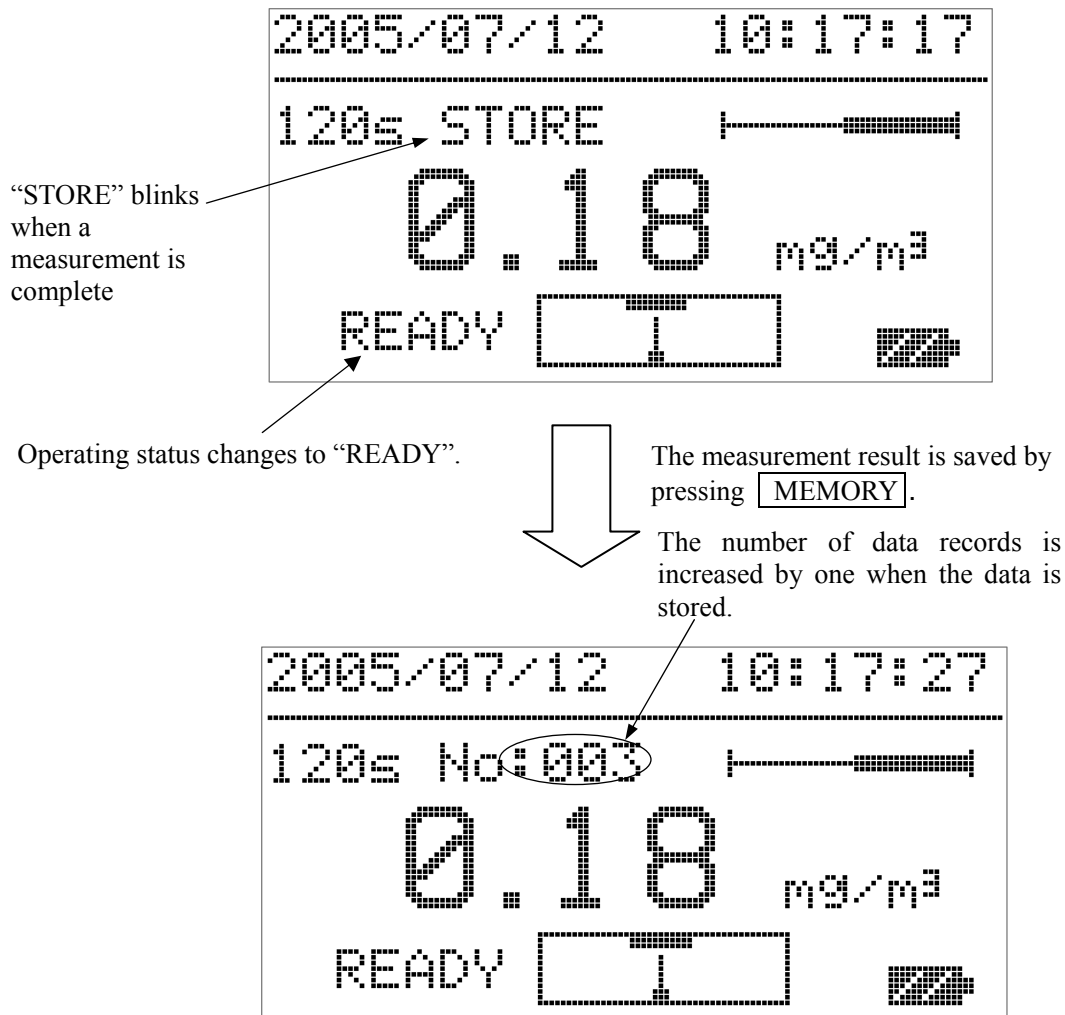

Caution:

When a measurement is complete, it is recommended that the sensor be cleaned before powering down the instrument. If accumulated dust is left on the sensor it will become hard to clean, and will lead to a gradual reduction of the measurable range.

6. Settings Menu

6.1 Main Menu

The following menu will be displayed by pressing [MENU] (when high voltage is not being supplied to the instrument). Use and to select an item.

To enter the sub-menu of each item, press [SET].

To return to the measurement screen, select “1. NORMAL” and press [SET].

```
MENU 0. NORMAL
      1. SAMPLING TIME
      2. DATA OUTPUT
      3. PRINT OUTPUT
      4. DATA CLEAR
      5. TIME ADJUST
      6. COMMUNICATION
```

6.2 Sampling Time Menu

To set the measurement sampling time

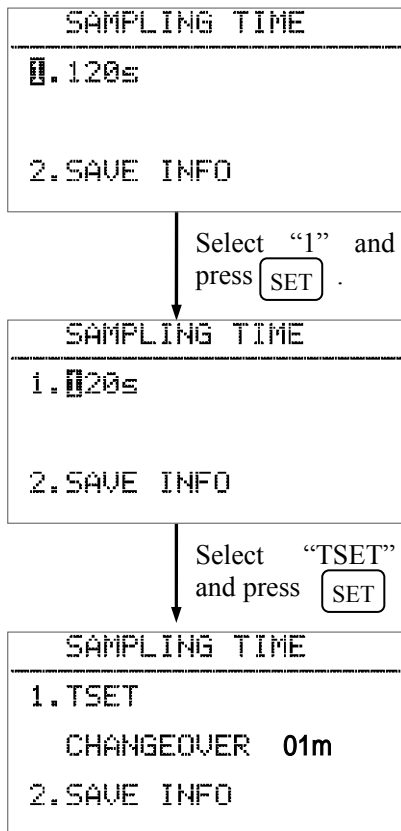

Move the cursor to item “2. SAMPLING TIME” of the main menu by using and then press [SET]. The screen on the left will be displayed.

Caution: If [MENU] is pressed before confirming changes by pressing [SET] at “2. SAVE INFO”, changes made to the time will NOT be saved.

Change the sampling time by using and . The setting will change as shown below:

120s → 24s → TSET

Press [SET] when 120s or 24s is highlighted if you wish to use one of the preset sampling times, then confirm the changes by pressing [SET] at “2. SAVE INFO”.

When [SET] is pressed when “TSET” is highlighted, the following screen will be displayed.

Set the time by using and . The sampling time range can be set from 1 to 60 minutes. Press [SET] when the sampling time has been set, then confirm the changes by pressing [SET] at “2. SAVE INFO”.

Note:

After completing the time setup, you can confirm your changes on the measurement screen. If you have set a custom time using TSET, the display will simply show “TSET” (the specified time will

6.3 Data Output Menu

To select and view stored data

Move the cursor to item “3. DATA OUTPUT” on the main menu by using and then press [SET]. The screen shown below will be displayed.

If there are no stored data records, the message “There is no record. Please set MENU key” will be displayed.

```

DATA OUTPUT   No: 000
-----
MASS CONCENTRATION
                0.18 mg/m³
DATE           2005/07/12
TIME          10:17:27
SAMPLING TIME 0120s
STATUS        0
    
```

Select a data storage number by using and . When you release the key, the contents of the data record (concentration, date/time, sampling time and sampling status) will be displayed.

- No: Data storage number
- MASS CONCENTRATION: Measured concentration value
- DATE / TIME: Date and time the measurement was performed
- SAMPLING TIME: Sampling mode: 24s, 120s or TSET (1-60min).
- STATUS: Sampling status: 0 or 1
 - 0: Normal measurement condition
 - 1: Indicates the measurable range was exceeded during the measurement in sampling mode 24s or 120s.

6.4 Time Adjustment Menu

To set the data and time

```

TIME ADJUST
-----
1. DATE   2005/07/12
2. TIME   10:17:27
3. SAVE INFO
    
```

Move the cursor to item “6. TIME ADJUST” on the main menu by using and then press [SET]. The screen on the left will be displayed.

Press [SET] when “1” is highlighted to change the date or when “2” is highlighted to change the time. The cursor will move to the date or time field as shown to the left.

Select “1.DATE”
and press

```

TIME ADJUST
-----
1. DATE   2005/07/12
2. TIME   10:17:27
3. SAVE INFO
    
```

Set the year, month and day (or hours, minutes and seconds) by using and . Press [SET] to proceed to the next field. When all the fields are set, the cursor will return to the left side of the screen.

Select “2.TIME”
and press

```

TIME ADJUST
-----
1. DATE   2005/07/12
2. TIME   10:17:27
3. SAVE INFO
    
```

Once the date and time are set use and to select “3.SAVE INFO” and press [SET].

Note: The time setting is confirmed when you press [SET]

it is recommended that you set the time for approx. 30-60 seconds ahead of the actual time, and then confirm the setting by pressing [SET] on "3.SAVE INFO" when the set time matches the actual time.

6.5 Communications Menu

To set the communications baud rate

Move the cursor to item "7.COMMUNICATION" of the main menu by using and , and press [SET]. The screen shown below will be displayed.

```
COMMUNICATION
-----
1. BAUDRATE
    19200
2. SAVE INFO
```

Select "1" by using and .

(The factory default setting is 9600.)

Select "1.BAUDRATE" and press

```
COMMUNICATION
-----
1. BAUDRATE
    19200
2. SAVE INFO
```

The baud rate can be changed by using and .

The setting changes as shown below:

19200 → 9600 → 4800

When [SET] is pressed, the cursor will return to the "1.BAUDRATE". To confirm the baud rate settings, select "2.SAVE INFO", and press [SET]. (If you do not confirm the settings by pressing [SET], the baud rate will not change.)

6.6 Data Clear Menu

To delete stored measurement data

Move the cursor to item “5.DATA CLEAR” on the main menu by using and then press [SET]. The screen shown below will be displayed. If there are no data records, a message “There is no record, Please set MENU key” will be displayed.

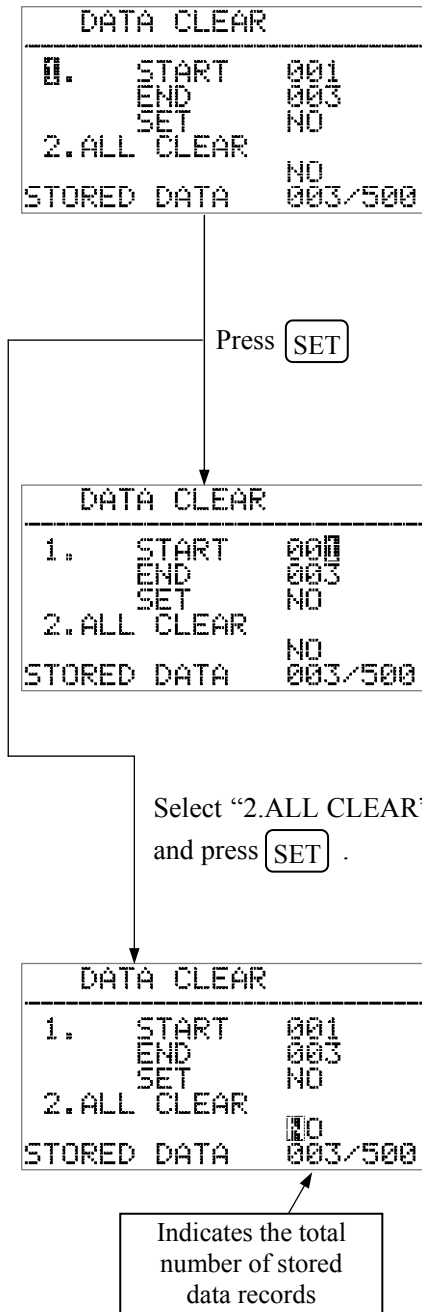

To select a specific range of data records to be deleted:

Select “1” by using and then press [SET]. The cursor will move to the START field as shown in the center screen on the left.

Use [SET] to move between fields, and and to change the values.

START: Input the number of the first data record you wish to delete.

END: Input the number of the last data record you wish to delete. (All the consecutive records within the set range will be deleted. To delete a single record set both start and end to the number of the data record you wish to delete.)

SET:

- To confirm deletion of the data records in the selected range, select YES and press [SET].
- To cancel deletion, select NO and press [SET].

To delete all the stored data records:

Move the cursor to “2.ALL CLEAR” and press [SET]. Switch between YES and No using and .

- To delete all the stored data records, select YES and press [SET]. All data will be deleted and the message “There is no record, Please set MENU key” will be displayed.
- To cancel deletion, select NO and press [SET].

Press [MENU] to return to the main menu.

7. Printing

7.1 Connecting the Printer

Connect the 3521 to the optional printer using the optional printer cable. (Refer to the operation manual of the printer for details.) Set the communication baud rate to 9600 bps. (The factory default setting is 9600 bps, so it is not necessary to set it unless it has been changed by the user.)

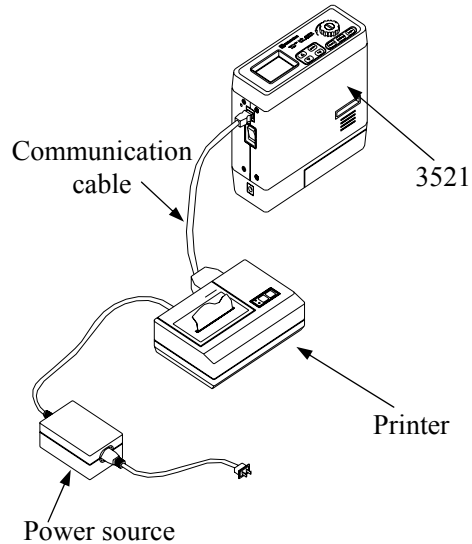

7.2 Print Output Menu

To print stored data

Move the cursor to “4. Print Output” on the main menu and press [SET]. If there are no stored data records, a message “There is no record, Please set MENU key” will be displayed.

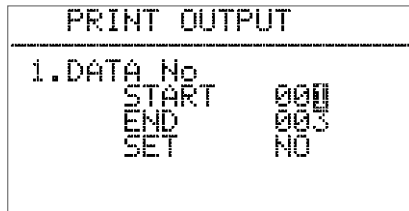

↓ Press [SET] key

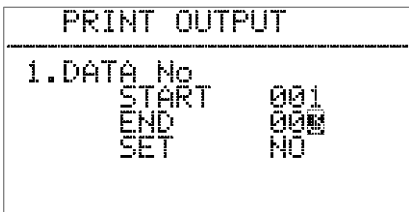

↓ Press [SET] key

Use [SET] to move between fields, and and to change the values.

START: Input the number of the first data record you wish to print.

END: Input the number of the last data record you wish to print. (All the consecutive records within the set range will be printed. To print a single record set both start and end to the number of the data record you wish to print.)

SET:

- To confirm printing the data records in the selected range, select YES and press [SET].
- To cancel printing, select NO and press [SET].

Note:

- 1) Before printing, confirm the communication settings between the instrument and printer are properly configured, and that the power supply is connected to the printer.
- 2) The baud rate of both the instrument and printer must be set to 9600 bps.
- 3) During printing the message “PRINT OUTPUT” will be displayed.

8. Regular Maintenance and Impactor Nozzle Replacement

Regular maintenance is required to ensure the long-term accuracy and performance of the instrument.

In order to maintain the initial accuracy, it is recommended that the sensor and impactor plate be cleaned before and after use. If the instrument is used for a long time, or used in a high concentration environment, periodical cleaning of the needle is recommended.

8.1 Impactor Cleaning

The impactor knob can be removed by turning it counter-clockwise. The impactor nozzle can also be removed by turning it counter-clockwise. To clean the impactor knob, wipe off the dust accumulated on the impactor plate with a neutral detergent or alcohol. To clean the impactor nozzle, blow clean air from the inlet to remove the dust. If water or alcohol is used, be sure to fully dry the parts before re-assembling.

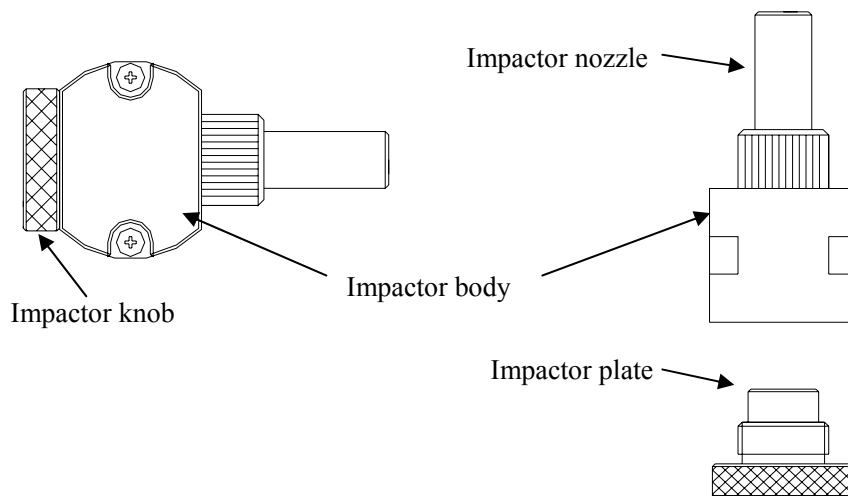

Note:

If a large amount of dust has accumulated on the impactor plate, rescattering may prevent accurate measurement.

8.2 Removing and Cleaning the Needle

When the knob is turned left to the “O” (open) mark, the knob will pop up. Pull out the knob slowly to remove the needle. Be careful not to damage the two O rings attached to the needle.

To clean the needle you will need an Ultrasonic Cleaner. Prepare a cleaning solution made up of 1/2 of the provided detergent and 1/2 purified water. The cleaning container should hold enough cleaning solution to cover just the lower portion of the needle. Place the needle in the solution and run the Ultrasonic Cleaner for approximately 15 minutes.

Note when placing the needle into the detergent, only the lower portion of the needle; up to the O ring, should be immersed. Do not dip the upper portion of the needle in the detergent.

Before re-inserting the needle into the instrument, ensure it is completely dry or damage to the instrument may occur.

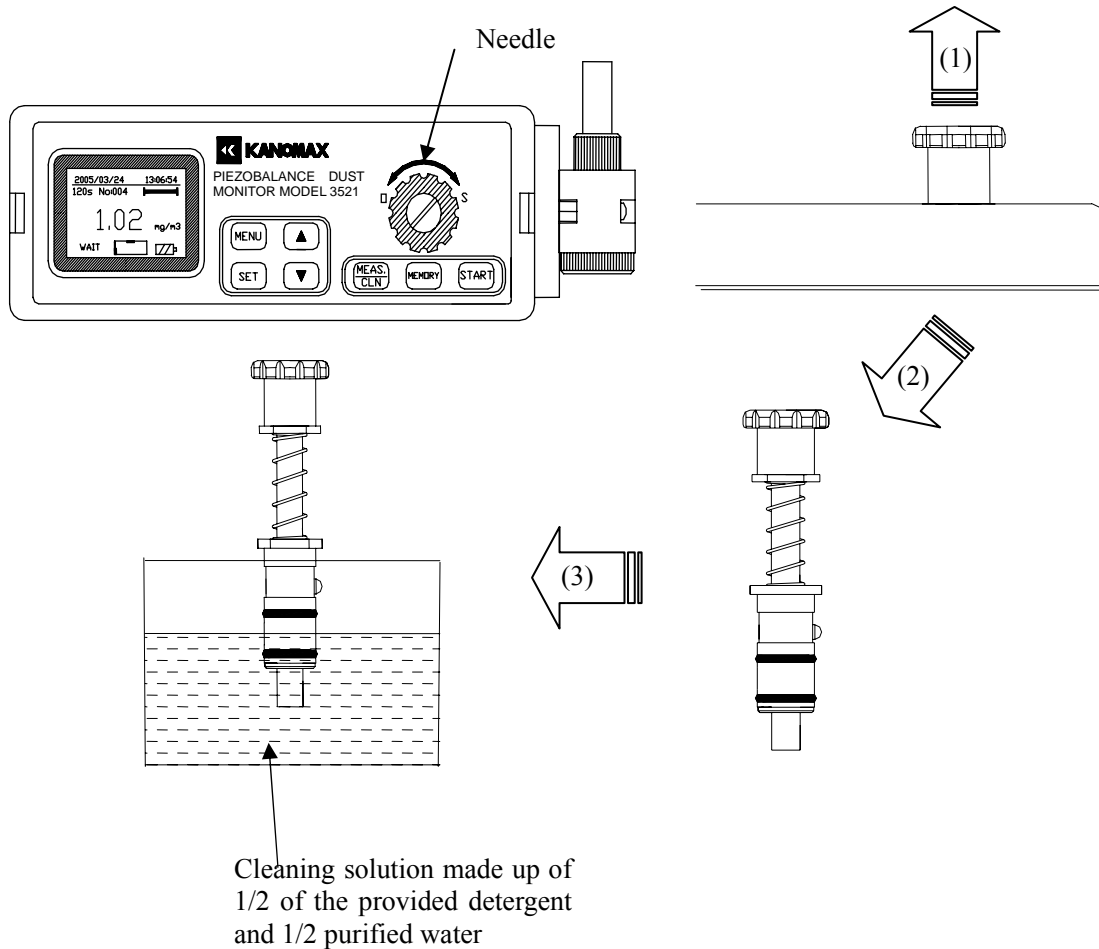

8.3 Installing the Needle

To reinstall the needle, look into the inlet from above and align the high-voltage terminal on the side of the needle with the groove inside the inlet, then slowly twist in the needle. When the needle is fully inserted, lock it in place by turning the knob to the “S” mark until it cannot be turned any further.

Turn on the power and press [MEAS/CLN] to confirm that high voltage current is being supplied, and that the pointer stops at the center of the high voltage indicator frame.

Caution:

- The needle should be removed only when necessary. Do not pull out the needle unless you are cleaning or replacing it.
- If the screw portion at the center of the knob is visible, the needle may not be inserted properly.

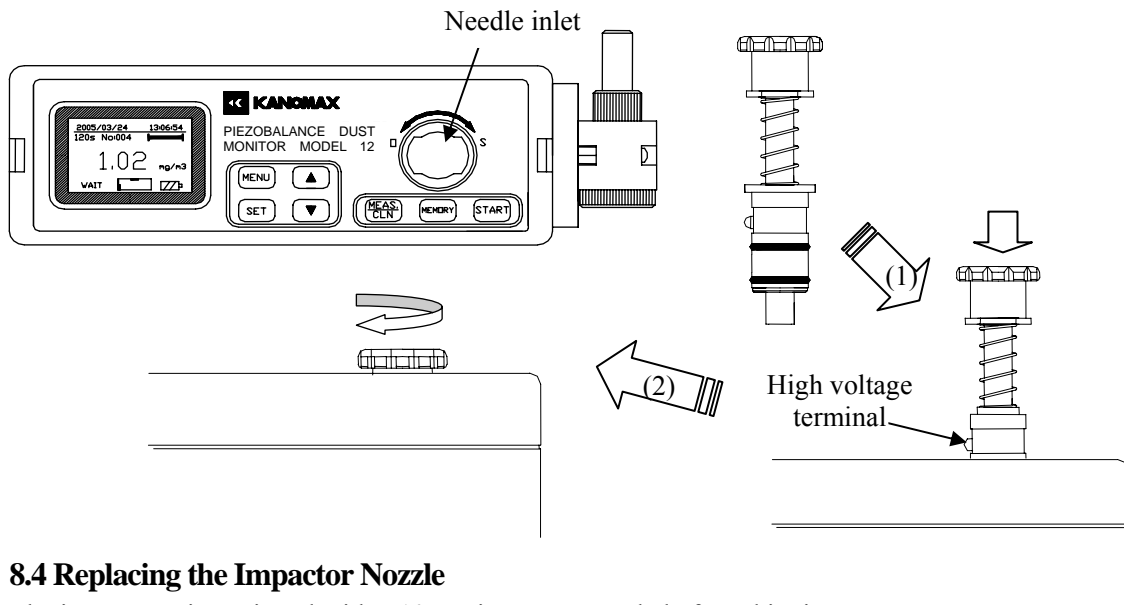

8.4 Replacing the Impactor Nozzle

The instrument is equipped with a 10 µm impactor nozzle before shipping.

To perform a working environment measurement, replace the 10 µm nozzle with the 4 µm nozzle.

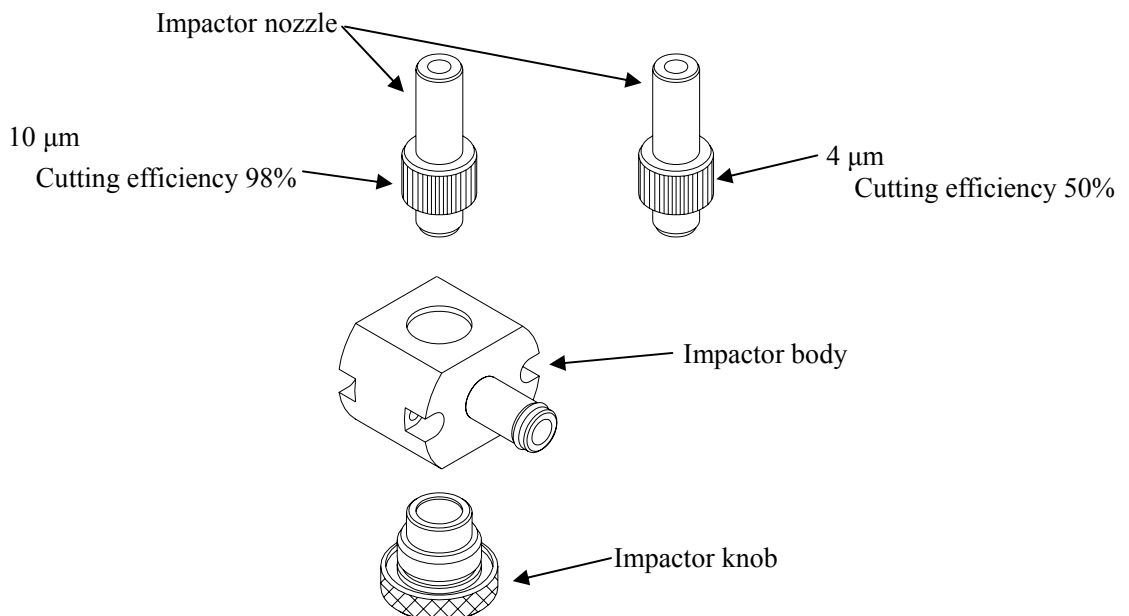

9. Main Specifications

Product Name	Piezobalance Dust Monitor
Model	3521
Measuring Object	Mass concentration of suspended particulate matter in indoor or outdoor air.
Operating Temperature Range	-10°C to 40°C (14°F to 104°F)
Storage Temperature Range	-30°C to 60°C (-22°F to 140°F)
Measuring Range	0.01 to 5mg/m ³
Measuring Particle Size	Φ 10 μm (below 98%) or Φ 4 μm (below 50%) (depends on which impactor nozzle is used)
Particle Sizing Method	Impactor (Inertial Impaction)
Measuring Time	24s, 120s, 1-60 min (Preset by the menu)
Measuring Accuracy	±10% of the calibration particles
Resolution	0.01mg/m ³
Suction Flow	1 L/min
Cleaning System	Manual cleaning of the sensor
Communication Protocol	Standard RS232C
Communication Baud Rate	4800bps, 9600bps, 19200bps (Preset by the menu)
Maximum Data Records	500 records
Weight	Approx. 1.8 kg (4 lbs.)
Dimensions	65×180×150 mm (2.6×7.1×5.9 inches) (W×L×H)
Power Source	1) AC/DC adapter (input: AC100-240V) 2) Built-in Ni-MH battery (9.6V-1.5AH), Continuous operation: approx. 4.5h with 5-8h charging time
Standard Accessories	1) Cleaning Device 3 2) Detergent/Purified Water30cc bottle (1 ea.) 3) Strap 1 4) AC Adapter 1 5) Φ4μm impactor nozzle 1 6) Communication Cable 1 7) Communication Software CD-ROM 1 8) Operation Manual 1 9) Carrying Case 1
Options	10) Printer 1 11) Printer AC/DC Adapter 1 12) Printer Cable 1

10. Troubleshooting

Please review the following troubleshooting tips before requesting a repair.

Symptom	Possible Cause	Solution
The display does not appear when the power is turned on.	Battery completely discharged.	Turn OFF the power and charge the battery.
	Contact failure of the battery pack.	Remove and reinstall the battery pack.
Blurred screen. (Hard to see LCD.)	The contrast of the display is not adjusted properly.	Adjust the contrast level, located on the side of the instrument, with a screw driver.
High voltage cannot be supplied	Needle is not inserted properly.	Remove and reinstall the needle.
	“WAIT” keeps blinking.	Remove any excess moisture from the cleaning device and repeat the cleaning procedure.
	“CLEANING” keeps blinking	Clean the sensor.
Concentration reading is “___ . ___”.	[START] is pressed during a measurement.	Repeat the measurement procedure.
	[MEAS/CLN] is pressed during a measurement.	Repeat the measurement procedure after turning on the high voltage supply.
Battery indicator is blinking.	Remaining battery power is low.	Charge the battery immediately.
	Battery contacts not seated properly.	Remove and reinstall the battery pack.
The measurable range does not recover even after cleaning.	Excess moisture on the sensor.	Remove any excess moisture from the cleaning device and repeat the cleaning procedure.
	Oily residue on the sensor.	Apply 1-2 drops of detergent to the smaller sponge of the cleaning device, insert the cleaning device up to the scale line, wait 4-5 minutes, and then pull out the cleaning device.
	The tip of the needle has fused due to high voltage arcing causing metal residue to attach to the sensor area (the crystal).	Pull out the needle and check the sensor area (the crystal). If discoloration is observed, the instrument must be sent out for repair.
Communication failure	Incorrect baud rate	Check the baud rate settings

11. Warranty and After-sales Service

KANOMAX Limited Warranty

The limited warranty set below is given by KANOMAX with respect to the KANOMAX brand Piezobalance Dust Monitor (Model 3521) and its attachment parts including accessories (hereafter referred to as “PRODUCT”) that you have purchased. PRODUCT you have purchased shall be the only one that the limited warranty stated herein applies to.

Your PRODUCT, when delivered to you in new condition in its original container, is warranted against defects in materials and workmanship as follows: for a period of one (1) year from the date of original purchase, defective parts or a defective PRODUCT returned to your sales representative, as applicable, and proven to be defective upon inspection, will be exchanged for new or comparable rebuilt parts, or a refurbished PRODUCT as determined by your sales representative. Warranty for such replacements shall not extend the original warranty period of the defective PRODUCT.

This limited warranty covers all defects encountered in normal use of the PRODUCT, and does not apply to the following cases:

- (1) Use of parts or supplies other than the PRODUCT sold by your sales representative, which cause damage to the PRODUCT or cause abnormally frequent service calls or service problems.
- (2) If any PRODUCT has its serial number or date altered or removed.
- (3) Loss or damage to the PRODUCT due to abuse, mishandling, improper packaging by the owner, alteration, accident, electrical current fluctuations, failure to follow operating, maintenance or environmental instructions prescribed in the PRODUCT's instruction manual provided by KANOMAX, or service performed by other than KANOMAX.

NO IMPLIED WARRANTY, INCLUDING ANY IMPLIED WARRANTY OF MERCHANTABILITY OR FITNESS FOR A PARTICULAR PURPOSE, APPLIES TO THE PRODUCT AFTER THE APPLICABLE PERIOD OF THE EXPRESS LIMITED WARRANTY STATED ABOVE, AND NO OTHER EXPRESS WARRANTY OR GUARANTY, EXCEPT AS MENTIONED ABOVE, GIVEN BY ANY PERSON OR ENTITY WITH RESPECT TO THE PRODUCT SHALL BIND KANOMAX. KANOMAX SHALL NOT BE LIABLE FOR LOSS OF STORAGE CHARGES, LOSS OR CORRUPTION OF DATA, OR ANY OTHER SPECIAL, INCIDENTAL OR CONSEQUENTIAL DAMAGES CAUSED BY THE USE OR MISUSE OF, OR INABILITY TO USE, THE PRODUCT, REGARDLESS OF THE LEGAL THEORY ON WHICH THE CLAIM IS BASED, AND EVEN IF KANOMAX HAS BEEN ADVISED OF THE POSSIBILITY OF SUCH DAMAGES. IN NO EVENT SHALL RECOVERY OF ANY KIND AGAINST KANOMAX BE GREATER IN AMOUNT THAN THE PURCHASE PRICE OF THE PRODUCT SOLD BY KANOMAX AND CAUSING THE ALLEGED DAMAGE. WITHOUT LIMITING THE FOREGOING, THE OWNER ASSUMES ALL RISK AND LIABILITY FOR LOSS, DAMAGE OF, OR INJURY TO THE OWNER AND THE OWNER'S PROPERTY AND TO OTHERS AND THEIR PROPERTY ARISING OUT OF USE OR MISUSE OF, OR

KANOMAX. THIS LIMITED WARRANTY SHALL NOT EXTEND TO ANYONE OTHER THAN THE ORIGINAL PURCHASER OF THE PRODUCT, OR THE PERSON FOR WHOM IT WAS PURCHASED AS A GIFT, AND STATES THE PURCHASER'S EXCLUSIVE REMEDY.

After-sales Service

If the PRODUCT is malfunctioning, please check with “Troubleshooting” to find possible causes first.

Repair parts are retained for a minimum period of five (5) years after production cessation of the PRODUCT. This storage period of repair parts is considered as the period during which KANOMAX can provide repair service.

For more information, please contact your sales representative. When you make a call, please have the following information of your PRODUCT at hand:

- (1) PRODUCT name;
- (2) Model number;
- (3) Serial number;
- (4) Description of Symptom, and;
- (5) Date of purchase