

Megohmmeter Model 6536

User Manual
ENGLISH



Measure up



Statement of Compliance

Chauvin Arnoux®, Inc. d.b.a. AEMC® Instruments certifies that this instrument has been calibrated using standards and instruments traceable to international standards.

We guarantee that at the time of shipping your instrument has met its published specifications.

An NIST traceable certificate may be requested at the time of purchase, or obtained by returning the instrument to our repair and calibration facility, for a nominal charge.

Serial #: _____

Catalog #: 2155.56

Model #: 6536

Please fill in the appropriate date as indicated:

Date Received: _____

Date Calibration Due: _____















Chauvin Arnoux®, Inc.
d.b.a AEMC® Instruments

Thank you for purchasing the **Megohmmeter Model 6536**.

For best results from your instrument:

- Read these operating instructions carefully
- Comply with the precautions for use

	WARNING, risk of DANGER! The operator must refer to these instructions whenever this danger symbol appears
	WARNING, risk of electric shock. The voltage applied to parts marked with this symbol may be hazardous
	Equipment is protected by double insulation
	The voltage on the terminals must not exceed 700V
	Ground/Earth
	Battery
	Information or useful tip
	Remote test probe
	The product is recyclable in accordance with standard ISO14040
	This instrument exceeds regulatory requirements with respect to recycling and reuse
	Indicates conformity with European directives, in particular LVD and EMC
	Indicates that, in the European Union, the instrument must undergo selective disposal in compliance with Directive WEEE 2002/96/EC. This instrument must not be treated as household waste

Definition of Measurement Categories (CAT)

- **CAT II** corresponds to measurements taken on circuits directly connected to low-voltage installations.
Example: power supply to electro-domestic devices and portable tools.
- **CAT III** corresponds to measurements on building installations.
Example: distribution panel, circuit-breakers, machines or fixed industrial devices.
- **CAT IV** corresponds to measurements taken at the source of low-voltage installations.
Example: power feeders and protection devices.

PRECAUTIONS FOR USE

This instrument is compliant with safety standard IEC 61010-2-030, and the leads are compliant with IEC 61010-031, for voltages up to 600V in CAT IV or 1000V in CAT III.

Failure to observe the following safety instructions may result in electric shock, fire, explosion, and damage to the instrument and installation.

- Carefully read and understand all precautions for use.
- Be aware of all electrical hazards when using this instrument.
- Using this instrument other than as specified may compromise its user protection features.
- The safety of any system in which this instrument is incorporated is the responsibility of the integrator of the system.
- This instrument can be used on CAT IV installations, for voltages not exceeding 600V_{RMS} with respect to ground or 700V_{RMS} maximum between terminals.
- Do not use the instrument on networks whose voltage or category exceeds those specified in this manual.
- Observe all environmental conditions of use (see § 3).
- Except for voltage measurements, take no measurements on electrically “live” systems.
- Do not use the instrument if it appears damaged, incomplete, or poorly closed.
- Before each use, check the condition of the insulation on the leads, housing, and accessories. Any part on which the insulation is deteriorated (even partially) must be set aside for repair or scrapping.
- Using the instrument without its battery compartment cover may result in electric shock to the user.
- Before using your instrument, ensure it is completely dry.
- Use only the leads and accessories supplied. The use of leads (or other accessories) of a lower voltage rating or category limits the use of the instrument/leads (or accessories) combination to the lowest category and service voltage.
- When handling the leads, test probes, and alligator clips, keep your fingers behind the physical guards.
- Before removing the battery compartment cover, ensure all measurement leads and accessories are disconnected. Replace all batteries at once. Use alkaline batteries.
- Use personal protection equipment where appropriate.
- All troubleshooting and metrological checks must be done by competent, accredited personnel.

Table of Contents

1. INTRODUCTION	4
1.1 Receiving Your Shipment.....	4
1.2 Accessories.....	5
1.3 Replacement Parts	5
1.4 Description.....	5
1.5 Front of Instrument	6
1.6 Back of Instrument.....	7
1.7 Terminals	8
1.8 Function Buttons.....	8
1.9 LCD Display	9
2. OPERATION.....	10
2.1 Setting Up the Instrument.....	10
2.1.1 Configuration Settings	10
2.1.2 Alarms.....	11
2.1.2.1 Activating/Deactivating the Alarm Function.....	11
2.1.2.2 Setting an Alarm Threshold.....	12
2.1.2.3 Viewing Alarms	13
2.1.3 Δ REL Function	13
2.1.4 HOLD Function.....	14
2.1.5 Backlighting	15
2.1.6 Standby Mode	15
2.2 Taking Measurements.....	15
2.2.1 Voltage Measurement.....	15
2.2.2 Insulation Measurement	17
2.2.2.1 TEST Button Operation.....	19
2.2.2.2 Timed Tests	19
2.2.2.3 Remote Control Probe (Optional)	20
2.2.3 Continuity Measurement.....	21
2.2.3.1 Lead Compensation.....	21
2.2.3.2 Continuity Measuring	22
2.2.4 Resistance Measurement.....	23
2.2.5 Floor Resistance Testing	24
2.2.5.1 Setup.....	25
2.2.5.2 Test Procedure.....	25
2.2.5.3 Measurement Results	28

3. SPECIFICATIONS	29
3.1 General Reference Conditions	29
3.2 Electrical Specifications	29
3.2.1 Voltage Measurement.....	29
3.2.2 Insulation Measurement	30
3.2.3 Continuity Measurement.....	31
3.2.4 Resistance Measurement.....	32
3.2.5 Timer.....	32
3.2.6 Floor Resistance Testing	32
3.3 Operating Environment.....	32
3.3.1 Voltage Measurement.....	32
3.3.2 Insulation Measurement	33
3.3.3 Resistance and Continuity Measurement.....	34
3.3.4 Intrinsic Uncertainty and Operating Uncertainty	35
3.4 Power Supply.....	35
3.5 Environmental Conditions.....	36
3.6 Mechanical Specifications	36
3.7 Safety Standards	36
4. MAINTENANCE & TROUBLESHOOTING	37
4.1 Maintenance	37
4.1.1 Cleaning	37
4.1.2 Replacing the Batteries	37
4.2 Troubleshooting	39
4.2.1 Errors.....	39
4.2.1.1 Voltage present before an insulation measurement.....	39
4.2.1.2 Range exceeded during an insulation measurement.....	39
4.2.1.3 Voltage during continuity/resistance measurement	40
4.2.2 Resetting the Instrument	40
4.3 Repair and Calibration.....	40
4.4 Technical and Sales Assistance.....	41
4.5 Limited Warranty.....	41
4.6 Warranty Repairs.....	41

1. INTRODUCTION

1.1 Receiving Your Shipment

Upon receiving your megohmmeter product package, ensure the contents are consistent with the packing list. Notify your distributor of any missing items. If the equipment appears to be damaged, file a claim immediately with the carrier and notify your distributor at once, providing a detailed description. Save the damaged packing container to substantiate your claim.

Ordering Information:

Megohmmeter Model 6536..... **Cat. #2155.56**
Megohmmeter Model 6536 ESD Floor Kit..... **Cat. #2155.57**

Shipping Contents:



Megohmmeter Model 6536



Soft Carrying Case



Two color-coded (red/black) 1.5m test leads,
two alligator clips, two grip probes and
one test probe (black)



ESD Floor Kit
(only with Cat. #2155.57)

Also includes 6 AA batteries and a user manual.

1.2 Accessories

Megohmmeter Test Probe (600V CAT IV)	Cat. #2155.75
Case - Field Case (Waterproof - Replacement for ESD Floor Kit) ...	Cat. #2118.98
Case - Hands Free Carrying Case	Cat. #2118.99
Continuity Pole	Cat. #2138.54

1.3 Replacement Parts

Lead - Set of 2, Color-coded 5 ft (Red/Black) Silicone Leads, Test Probes & Alligator Clips {Rated 1000V CAT IV}	Cat. #2152.05
Probe - Set of 2, Color-coded (Red/Black) Grip Probes.....	Cat. #2152.26
Weights - Set of 2, 5 lbs each with conductive rubber bottom pad (RoHS).....	Cat. #2155.76
Adapter - 4mm non-insulated for safety leads (Replacement for ESD Floor Kit).....	Cat. #1017.45

1.4 Description

The Megohmmeter Model 6536 is a portable measuring instruments with digital displays, and is powered by batteries. The instrument measures insulation with test voltages from 10 to 100V in one-volt steps. Other features include:

- Continuity measurement
- Resistance measurement
- Programmable alarms

The Model 6536 is also available as a floor resistance testing kit (see § 2.2.5) for testing both point-to-ground and point-to-point electrostatic discharge (ESD). In addition to the instrument, the kit contains two 5 lb (2.3 kg) floor weights (also referred to as NFPA probes) that are in compliance with EOS/ESD 11.11 specifications. Each floor weight is coated with insulating paint and a conductive rubber base. The instrument, floor weights, and test leads are packaged in a rugged field case. The kit provides all the necessary elements for compliance with the ANSI/ESD STM97.2-2006 standard for testing ESD flooring.

1.5 Front of Instrument

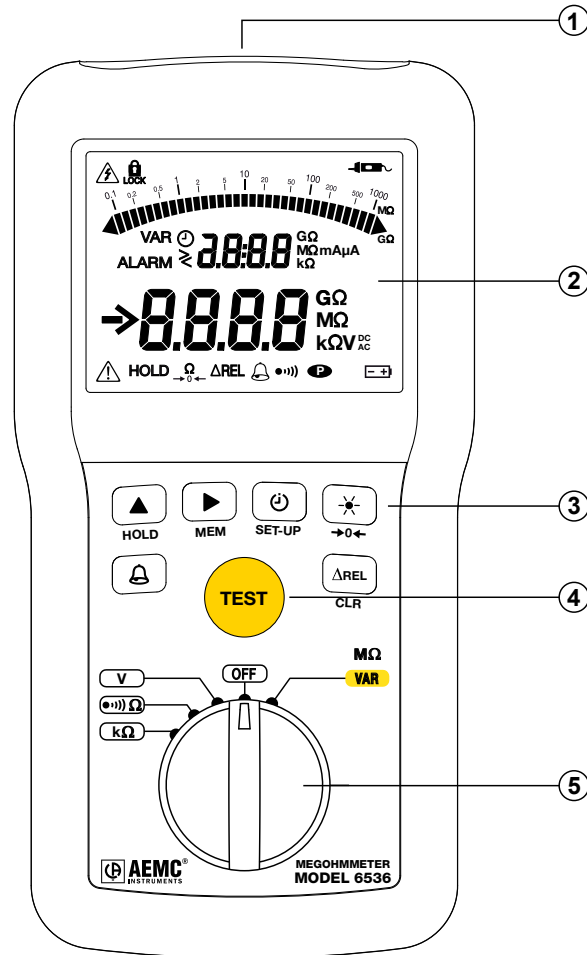

Figure 1

1. Input terminals
2. Blue backlit LCD
3. Six function buttons (see § 1.8)
4. **TEST** button to start insulation measurements (see § 2.2.2.1)
5. Five-position rotary switch to choose the function or to turn the instrument OFF

1.6 Back of Instrument

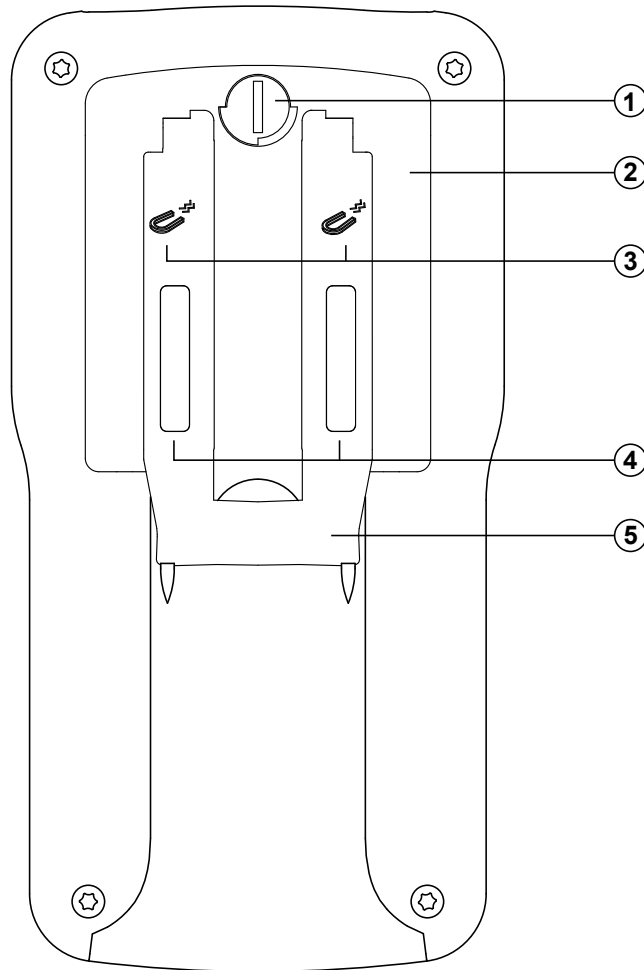

Figure 2

1. Captive quarter-turn screw
2. Battery compartment cover
3. Mounting magnets, molded into instrument case
4. Non-skid pads
5. Stand

1.7 Terminals

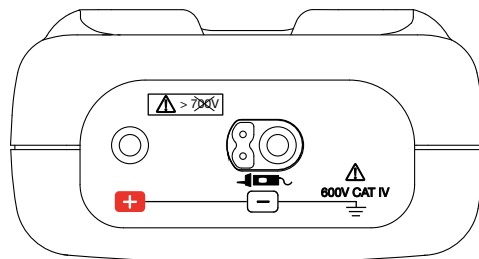

Figure 3

The instrument has one positive (+) terminal and one negative (-) terminal. The negative terminal also supports the remote probe accessory (see § 2.2.2.3).

1.8 Function Buttons

Several keys have two functions. One is marked on the key, and is enabled via a short press. The second function is marked under the key, and is enabled by a long (>2 seconds) press.

BUTTON	DESCRIPTION
	Selects the and functions (§ 2.2.2).
	Toggles backlighting ON and OFF (§ 2.1.5).
HOLD	Freezes/unfreezes the displayed measurement on the LCD (§ 2.1.4).
SET-UP	Accesses the instrument's setup parameters and information (§ 2.1.1).
	Applies lead compensation in continuity testing (§ 2.2.3.1).
	Activates/deactivates alarms (§ 2.1.2).
	The and keys allow you to: <ul style="list-style-type: none"> ■ Modify the display and program the durations of insulation measurements (§ 2.2.2.2). ■ Choose the continuity test current (§ 2.2.3). ■ Program the alarm thresholds (§ 2.1.2).
ΔRel	Displays the difference between the present measurement and a stored reference measurement (§ 2.1.3).

1.9 LCD Display

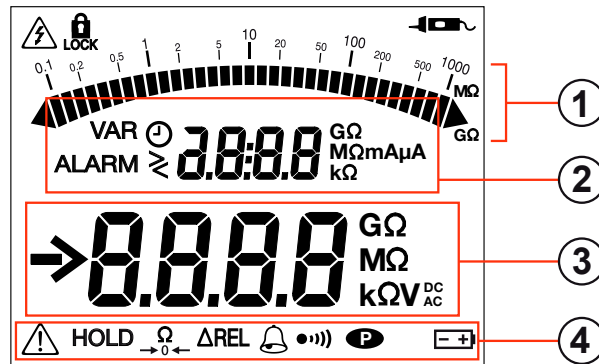

Figure 4

1. Logarithmic bar graph displays insulation measurements
2. Secondary display area
3. Main display area
4. Icons/indicators

When the measured value is below the minimum, the instrument displays - - - - .

When measuring voltage, if the reading falls outside the range defined by the positive and negative limits, the instrument displays **OL** or **- OL**.

2. OPERATION



Except when measuring voltage, all measurements must be made on powered-off systems. Therefore check to ensure there is no voltage on the system under test before making a non-voltage measurement. When the rotary switch is set to the voltage or an insulation testing position, the instrument measures and displays any voltage present at the input terminals prior to the user pressing the test button.

2.1 Setting Up the Instrument

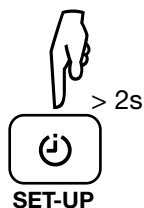

2.1.1 Configuration Settings



A >2 second press of the **SET-UP** button enables you to change configuration settings on the instrument. You can then use the ▲ and ► buttons to scroll through and modify parameters.

In Set-Up mode, the ▲ button performs the following functions:

<p>1st press on ▲</p>		<p>The alarm buzzer is active. To deactivate it:</p> <ol style="list-style-type: none"> 1. Press ►. On will blink to indicate it is selected. 2. Press ▲ to change the setting to OFF. 3. Press ► to validate the change. <p>The ●))) symbol disappears from the display when you exit Set-Up.</p> <p>Note that this setting reverts to On when you turn OFF the instrument.</p>
----------------------------------	--	--

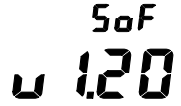
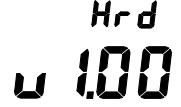

2 nd press on ▲		<p>Automatic switching to standby mode is activated. To deactivate it:</p> <ol style="list-style-type: none"> 1. Press ► to select OFF (the setting blinks). 2. Press ▲ to change the setting to On. 3. Press ► to validate the change. <p>The P symbol appears on the display when you exit Set-Up.</p> <p>Note that this setting reverts to OFF when you turn OFF the instrument.</p>
3 rd press on ▲		Displays the instrument model number.
4 th press on ▲		Displays the instrument firmware version.
5 th press on ▲		Displays the instrument hardware version.
6 th press on ▲		Return to the first press.

2.1.2 Alarms

The instrument includes an alarm function that sounds an audible buzzer when a defined alarm condition is measured.

2.1.2.1 Activating/Deactivating the Alarm Function



The alarm function is available in insulation, resistance, and continuity measurement modes. Pressing the  button activates the alarm. The  symbol appears on the LCD, along with the threshold value.

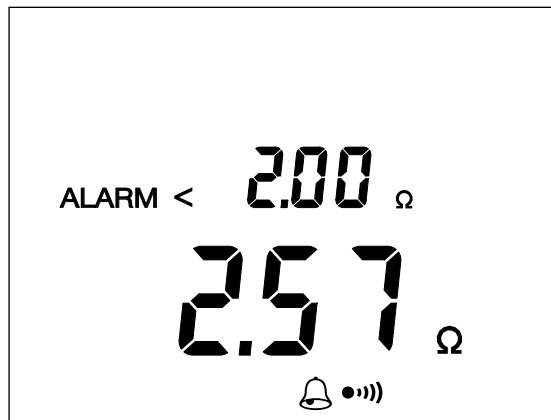

To turn OFF the alarm buzzer while it is sounding, press the **HOLD** button. To deactivate an active alarm function, press the  button.

2.1.2.2 Setting an Alarm Threshold

While  is displayed indicating the alarm function is active, you can change the alarm threshold by pressing the **▲** button (except during insulation measurements). For each testing mode, there are three pre-defined threshold values:

- Continuity: < 2Ω, <1Ω and <0.5Ω
- Resistance: >50kΩ, >100kΩ and >200kΩ
- Insulation: <10kΩ, <50kΩ and <100kΩ

In each measurement mode, the third threshold can be replaced by a user-defined value. To do this:

1. Press the **▶** button while the threshold value is displayed.
2. The **>** symbol starts blinking; you can change it to **<** by pressing the **▲** button. This symbol indicates the direction of the alarm threshold: **<** for a low threshold and **>** for a high threshold.
3. To change the threshold setting, press the **▶** button to navigate to the first digit, and then use the **▲** button to change its value.
4. Use the **▶** and **▲** buttons to select and change the other digits in the threshold value, as well as the units of measurement.
5. When finished setting the threshold, press the **▶** button to validate the setting.

2.1.2.3 Viewing Alarms

When the measurement is below a low alarm threshold or above a high alarm threshold, the instrument emits a continuous audible signal and the LCD indicates the threshold crossed:

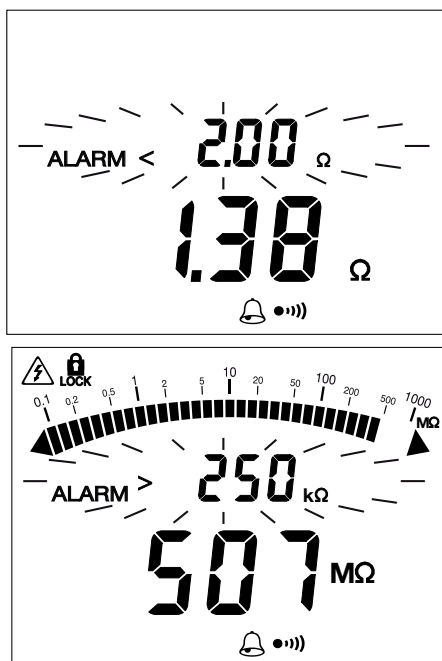

When checking continuity, this enables you to determine whether or not the continuity measurement is less than 2Ω simply by listening, without looking at the display. You can similarly check insulation quality.

2.1.3 ΔREL Function



For an insulation or resistance measurement, you can configure the instrument to subtract a reference value from the measured value and display the difference.

To activate this function, press the **ΔREL** button during an active measurement. This measurement becomes the reference (R_{ref}) and will be stored and subtracted from subsequent measurement values (R_{meas}). The **ΔREL** symbol appears on the LCD while this function is activated.

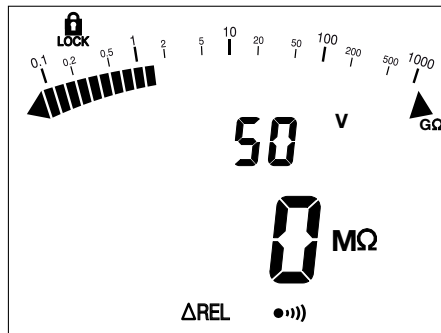

If the measured value is less than the stored value, the display becomes negative.

You can display the difference as a percentage of the reference ($\frac{R_{meas} - R_{ref}}{R_{ref}} \times 100$) by pressing the ► button until the % sign appears:

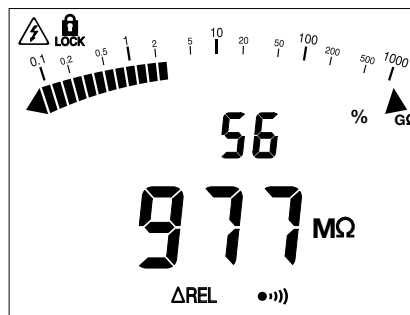

 For insulation measurements, only the digital display is modified by ΔREL . The bar graph continues to display the true measured value.

To deactivate the ΔREL function, press the ΔREL button during an active measurement, or turn the rotary switch to another setting.

2.1.4 HOLD Function



Pressing the **HOLD** button freezes the display of the measurement. This can be done in all functions except during a timed measurement (⌚).

To unfreeze the display, press the **HOLD** button again.

2.1.5 Backlighting





Pressing the ☀ button turns ON backlighting for the LCD.

To switch it OFF, press the ☀ button again. Otherwise, backlighting goes OFF automatically at the end of one minute.

2.1.6 Standby Mode

After 5 minutes of operation with no user activity, the instrument automatically switches to standby mode. To restore normal operation, simply press any button. The instrument returns to the state it was in prior to entering standby mode, with no loss of information (value of the last measurement, compensation of the leads, Δ REL, timed mode, alarm, etc.).

Automatic switching to standby mode is disabled during:

- insulation measurements in  mode and in  mode.
- continuity measurements, for as long as measurements are made.

Automatic switching to standby is disabled via the **SET-UP** button (see § 2.1.1).

2.2 Taking Measurements

2.2.1 Voltage Measurement



To ensure proper and accurate operation of the instrument, we recommend measuring a known voltage (such as an electrical outlet) before measuring unknown voltages.

1. Set the switch to **V** or **MΩ VAR**.

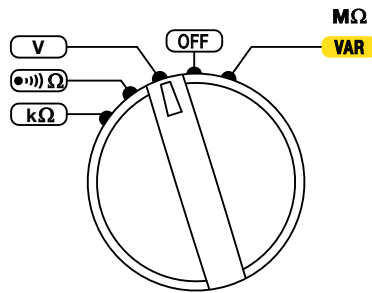

- Using the leads, connect the system to be tested to the instrument's terminals.

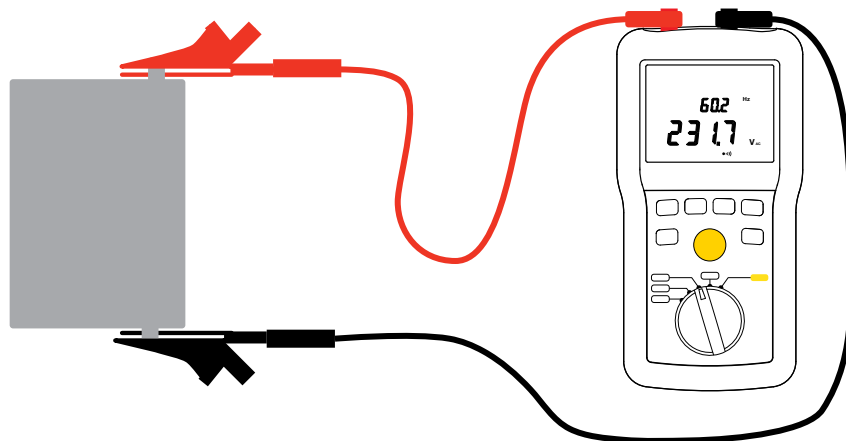

The instrument displays the voltage on the terminals. It detects whether the voltage is AC or DC.

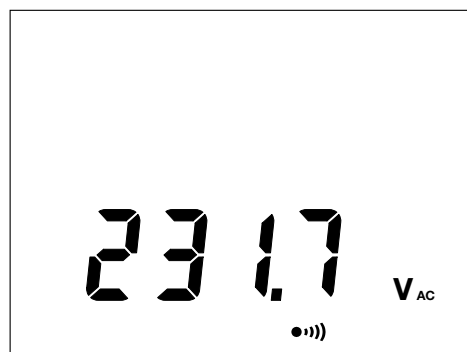

In the **MΩ VAR** setting, the  symbol indicates that the voltage is too high (>25V) and that insulation measurements are prohibited.

If the voltage is >15V, continuity and resistance measurements are prohibited.

2.2.2 Insulation Measurement



Insulation measurement results can be affected by the impedances of additional circuits connected in parallel or by transient currents.

Do not start any measurement while the symbol  is displayed.

1. Set the rotary switch to the **MΩ VAR** position.

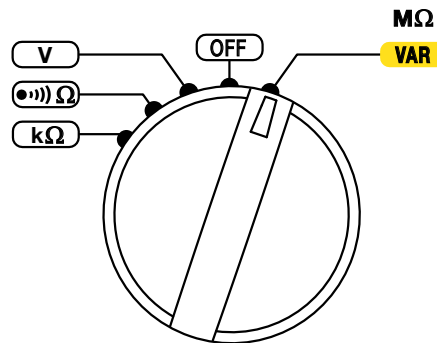

2. The instrument displays the configured test voltage. To modify this setting, press the **▶** key to enter edit mode (The first digit of the voltage setting blinks). You can change this by pressing the **▲** key. Then use the **▶** and **▲** keys to navigate to and change the remaining digits. Allowable test voltages are 10 through 100V. When finished, press **▶** to validate the change.
3. Use the leads to connect the system to be tested to the instrument's terminals. The system under test must be powered down and discharged. When testing insulation, the typical connection is negative (black) lead to conductor and positive (red) lead to ground or the outer insulation of the device under test.

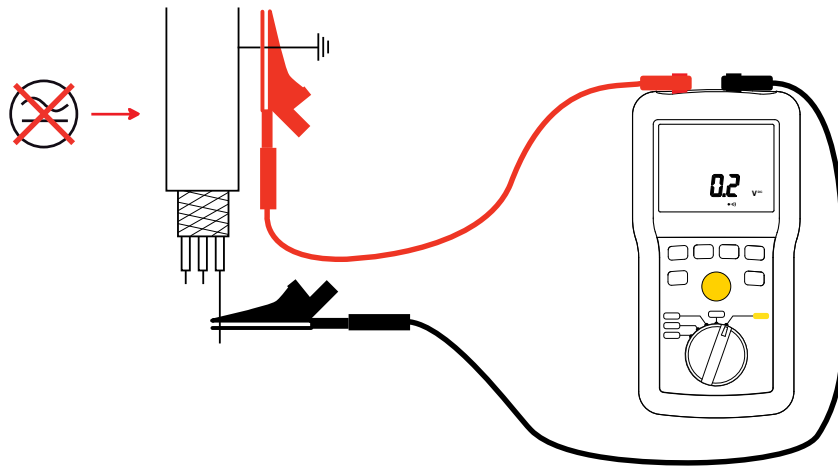

3. (Optional) Press the ► button to display the current or the elapsed time. (You can also do this during the measurement.)
4. Press the **TEST** button and hold it down until the displayed measurement is stable. Note that if the instrument detects a voltage greater than 25V in the system under test, pressing the **TEST** button has no effect because the test will be prohibited. (An error screen will appear.)
5. The resistance measurement is displayed on the LCD's main display area and on the bar graph. The secondary display area indicates the test voltage generated by the instrument.

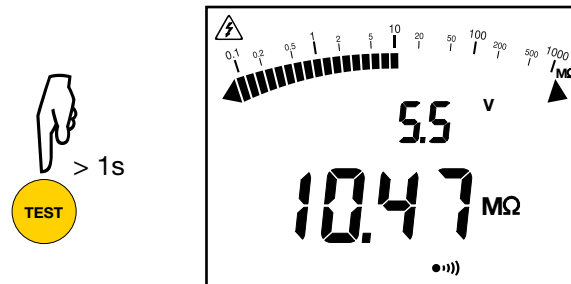

The ⚡ symbol indicates that the instrument is generating a hazardous voltage (>70V).

6. At the end of the measurement, release the **TEST** button. The instrument stops generating the test voltage and discharges the device being tested. The ⚡ symbol is displayed until the voltage on the system under test has fallen below 70V.





NOTE: Do not disconnect the leads and do not start any measurement while the symbol  is displayed.

When you release the **TEST** button, the measurement results remain displayed until the next measurement, or the **HOLD** button is pressed, or the instrument is turned OFF.

2.2.2.1 TEST Button Operation









Pressing the **TEST** button starts an insulation measurement. In normal mode, the test voltage is generated for as long as the button is pressed. When the button is released, the measurement stops.

In  mode, press the test button once to start the measurement, then press it a second time to stop; there is no need to keep the button pressed. However, if you do not stop the measurement, it will stop automatically after 15 minutes.

In timed test mode () press the **TEST** button once to start the measurement. The test will stop automatically at the end of the defined test duration time.

2.2.2.2 Timed Tests

The **TIMER**  button activates timed test mode. This button is active only for insulation measurements.

1 st press	 LOCK	This locks the TEST button. After you start the measurement, it continues to run without requiring you to keep the TEST button pressed. The test will run until you stop it, or when 15 minutes have passed.
2 nd press	 2:00	This activates timed test mode. You can set a test duration between 1 and 39:59 minutes. Use the  and  buttons to modify the value displayed. When the time duration is displayed, press the  button to enter edit mode. When the first digit blinks, you can change it using the  button. Press  to go to the next digit and  to change it. Then press  to validate.
3 th press		Exits timed test mode.

When  is activated, pressing the **TEST** button starts the test. The LCD displays the measurement, along with a “countdown” timer showing the time remaining in the test. The test automatically stops when the duration end time is reached and the result is displayed.



Successive presses on the ▲ button display intermediate values. These include:

- programmed time
- voltage at the end of the measurement
- current at the end of the measurement



Press the **TEST** button to return to voltage measurement.

2.2.2.3 Remote Control Probe (Optional)

The optional remote control probe is used to trigger the measurement using the **TEST** button on the probe. To use this accessory, refer to its separate operating instructions.

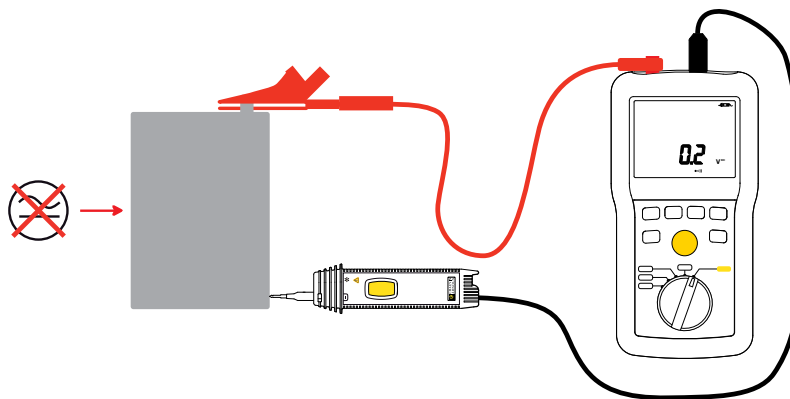

When the probe is connected, the  symbol is displayed on the instrument's LCD.

2.2.3 Continuity Measurement

Continuity measurement measures a low resistance (<10 or 100Ω depending on the current) at a high current (200 or 20mA).

 A current of 20mA reduces the power consumption of the instrument, increasing its battery life. However, the standard IEC 61557 requires 200mA current for continuity testing.

If an external voltage >15V is detected in the system under test during the continuity measurement, the instrument is protected without a fuse. The continuity measurement is stopped and the instrument reports an error until the voltage disappears.

2.2.3.1 Lead Compensation

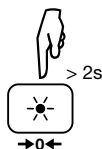

Before checking continuity, you should compensate for the resistance of the measurement leads. This ensures that the resistance measurement excludes the resistance in the leads. To do this, set the rotary switch to Ω . Then short-circuit the measurement leads and press the $\rightarrow 0 \leftarrow$ button for >2 seconds.

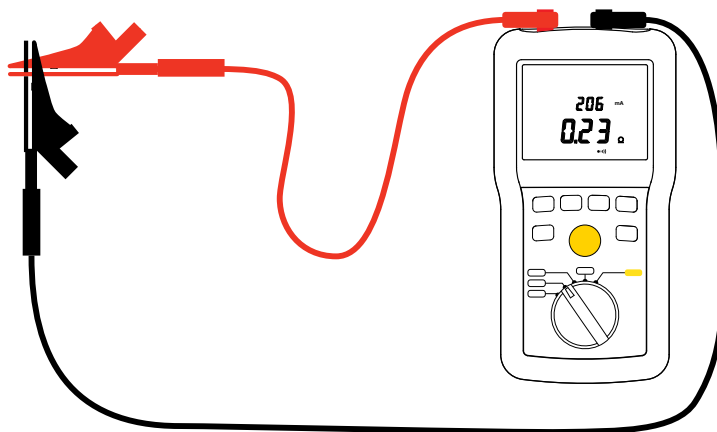

The display changes to zero and the $\rightarrow 0 \leftarrow$ symbol is displayed. The resistance of the leads will be systematically subtracted from all continuity measurements. If the resistance of the leads is >10Ω, there is no compensation. The compensation remains in memory until the instrument is turned OFF.

If the leads are changed with no change of compensation, the display may become negative. The instrument reports that the compensation must be redone by displaying a blinking $\rightarrow 0 \leftarrow$ symbol.

To remove the compensation of the leads, leave the leads open and press the $\rightarrow 0 \leftarrow$ button for >2 seconds. The LCD displays the resistance of the leads and the $\rightarrow 0 \leftarrow$ symbol goes off.

2.2.3.2 Continuity Measuring

1. Set the rotary switch to $\bullet \text{---}) \Omega$.

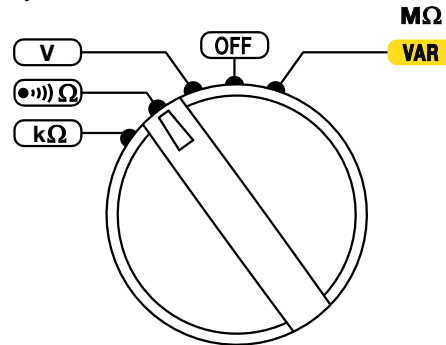

2. Press the \blacktriangleright button to display the measurement current. The measurement current appears blinking on the LCD. You can change the current by pressing the \blacktriangleright button.
3. Use the leads to connect the instrument to the system to be tested. The system to be tested must be powered down.

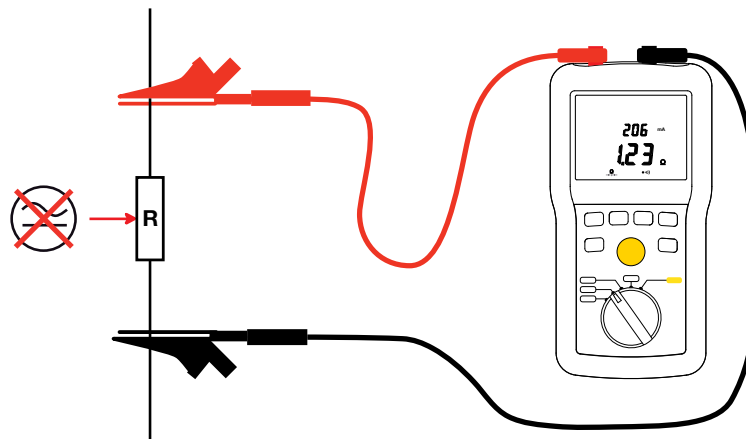

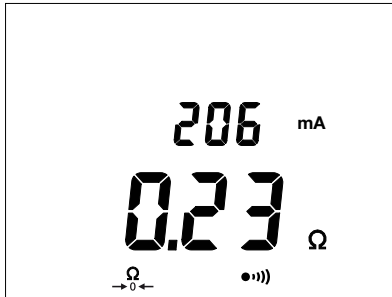

The instrument displays the resistance and the current used in the test.

To obtain a continuity value per standard IEC 61557:

1. Take a measurement at 200 mA and note its value, R1.
2. Reverse the leads and note the value R2.
3. Calculate the mean:

$$R = \frac{R_1 + R_2}{2}$$

2.2.4 Resistance Measurement

Resistance measurements are made with a low current.

1. Set the rotary switch to kΩ.

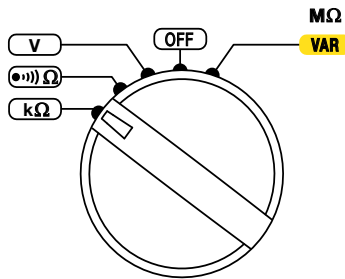

2. Connect the system to be tested to the instrument. The device to be tested must be powered down.
3. The instrument displays the results.



2.2.5 Floor Resistance Testing

ANSI/ESD STM97.2-2006 is the standard test method for measuring the electrostatic voltage on a person in combination with floor materials and footwear as a system. ESD STM 97.2 can be used to characterize ESD protective floor materials including floor coverings (tiles, carpets, epoxies, and laminated structures), mats, paints/coatings, and floor finishes. Electrostatic voltage must be less than +/-100V.

The Model 6536 can be purchased as part of a kit specifically designed for testing floor resistance in areas where electrostatic discharge is a concern, such as computer rooms, electronic assembly rooms, and hospitals. In addition to the instrument, the kit includes a 25-foot (7.6m) shielded lead and two 5 pound (2.3kg) floor weights (also called NFPA probes) for consistent and repeatable contact with the surface under test. The floor weights are in compliance with EOS/ESD 11.11 specifications. Each floor weight is coated with insulating paint and rubber base.



The instrument, floor weights, and test leads are packaged in a rugged field case. The kit provides all the necessary elements for compliance with the ANSI/ESD STM97.2-2006 standard for testing ESD flooring. The kit can test the effectiveness of conductive carpets, mats, tables, chairs, and other items.

The following simplified procedure is an extrapolation from the ANSI/ESD STM97.2-2006 standard. You may also refer to other sources for alternate procedures.

2.2.5.1 Setup

- The floor sample should consist of a section covering 48 x 48" (122 x 122cm) in area.
- When the sample is to be tested after installation, the test area dimensions should not exceed a section of floor 20 x 20' (6.1 x 6.1m).
- Whenever possible, condition the test area at least 24 hours at 73.4°F ±1.8°F (23°C ±1°C) and 50% ±5% RH and test under the same conditions.

2.2.5.2 Test Procedure

1. For uninstalled panels: Place the dry specimen on a nonconductive surface and lightly wipe with a lint-free cloth to remove any foreign material prior to placing the weights. Place the weights 2" (5.1cm) from an edge of the sample and 36" (91cm) apart. Apply 100V and take a reading five seconds after application of the voltage.
2. For installed panels: Place the weights 36" (91cm) apart and at least 36" (91cm) from any ground connections or grounded object resting on the floor sample. Apply 100V and take a reading five seconds after application of the voltage.
3. Unless otherwise specified, make five measurements on each floor section with the weights at different locations for each measurement, and record the value to two significant figures (see Figure 5 below).

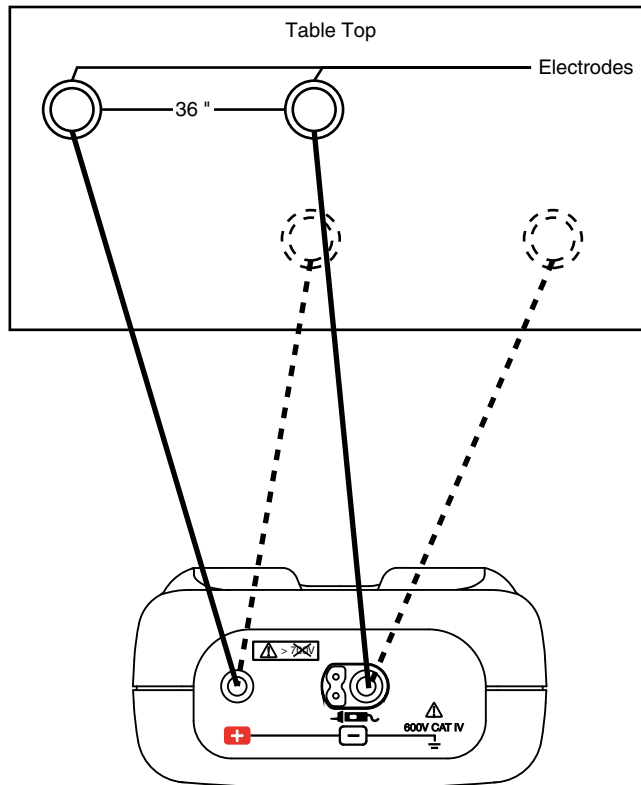

Figure 5

4. Repeat this procedure with the Model 6536 connected between one weight and a known electrical ground (Figure 6).

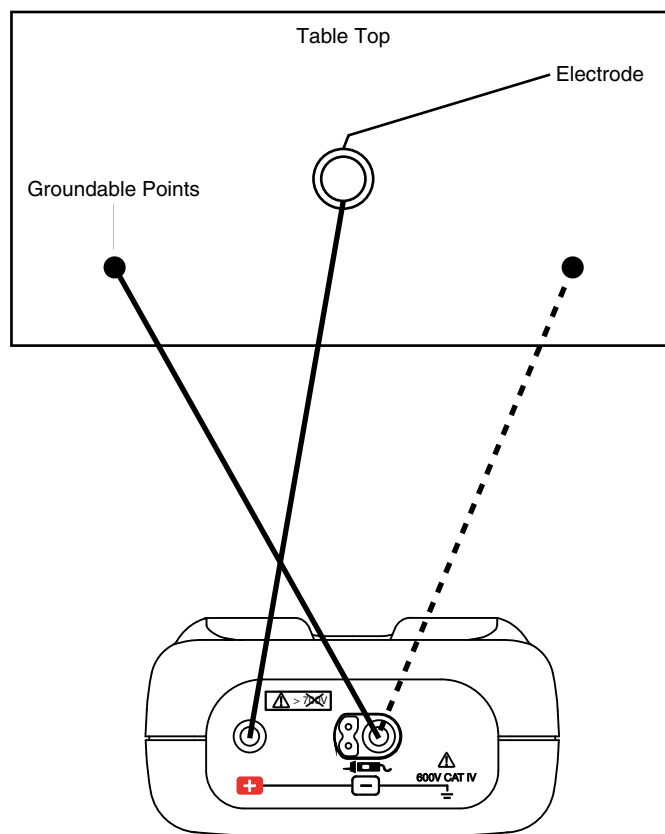

Figure 6

For an uninstalled floor sample (step 1) the ground should be part of the sample panel. For an installed floor sample (step 2) the ground should be a water pipe or known electrical ground. Swap the leads at the instrument for each measurement and record the average value obtained as the value for that measurement.

5. When finished, turn off the Model 6536 and return it to the case.

If the resistance changes with time during a measurement, the value observed after about 5 seconds should be considered the measured value.

2.2.5.3 Measurement Results

The following values may serve as a minimum resistivity level to provide an appropriate level of protection in manufacturing environments.

- Resistance from electrode to electrode (Figure 5): Measured value: $\geq 1\text{M}\Omega$
- Resistance from test electrode to a groundable point (Figure 6): Measured value: $\leq 10,000\text{M}\Omega$ ($10\text{G}\Omega$)

3. SPECIFICATIONS

3.1 General Reference Conditions

Quantity of Influence	Reference Values
Temperature	23° ± 3°C (73.4° ± 5.4°F)
Relative humidity	45 to 55% RH
Frequency	DC and 45 to 65Hz
Supply voltage	8 ± 0.2V battery life indication 58% ± 8%
Electric field	0V/m
Magnetic field	< 40A/m

- **The intrinsic uncertainty** is the error specified for the reference conditions.
- **The operating uncertainty** includes the intrinsic uncertainty plus variations of the quantities of influence (position, supply voltage, temperature, etc.) as defined in standard IEC 61557.



In this section, uncertainties are typically expressed as % of the reading (R) plus number of display counts (ct).

3.2 Electrical Specifications

3.2.1 Voltage Measurement

Specific reference conditions: Peak factor = 1.414 in AC, sinusoidal signal.

Measurement Range	0.3 to 399.9V	400 to 700V
Resolution	0.1V (AC and DC)	1V (AC and DC)
Accuracy	± (3% R + 2 ct)	
Input impedance	400kΩ	
Frequency ranges	DC and 15.3 at 800Hz	

3.2.2 Insulation Measurement

Specific reference condition: Capacitance in parallel on resistance = null.

Test Voltage (V_T)	R
10 to 100V	$(V_T/5)k\Omega$ to $(V_T/5)G\Omega$

Accuracy

Test Voltage (V_T)	10 to 100V				
Measurement Range	2 to 999k Ω and 1.000 to 3.999 M Ω	4.00 to 39.99M Ω	40.0 to 399.9M Ω	400 to 3999M Ω	4.00 to 20.00G Ω
Resolution	1k Ω	10k Ω	100k Ω	1M Ω	10M Ω
Accuracy	$\pm (3\% + 2 \text{ ct} + (10\%/V_T) \text{ per M}\Omega)$				

With a test voltage $\geq 50V$ and an insulation resistance $\leq 2G\Omega$, the accuracy is $\pm (3\% + 2 \text{ ct})$.

Bar Graph

Measurement Range	0.1M Ω to 50G Ω *
Resolution	9 segments per decade
Accuracy	$\pm (5\% R + 1 \text{ segment})$

*When the measurement range is exceeded, the whole bar graph is displayed.

Test Voltage (V_T)

Measurement Range	0.0 to 100V
Resolution	0.1V
Accuracy	$\pm (3\% R + 3 \text{ ct})$

Typical Discharge Time after Test

To go from V_T to 25V, the discharge time is $< 2s/\mu F$.

Test Current

Maximum test current: 2mA

Measurement Range	0.01 to 39.99µA	40.0 to 399.9µA	0.400 to 2.000mA
Resolution	10nA	100nA	1µA
Accuracy	± (10% R + 3 ct)		

Typical test voltage vs load curve

The voltage as a function of the measured resistance is illustrated below:

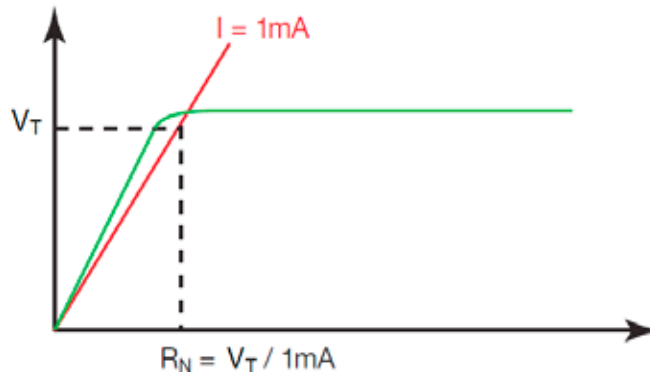

The range of operation per IEC 61557 is from 100kΩ to 2GΩ (see § 3.3.4).

3.2.3 Continuity Measurement

Specific reference condition: Inductance in series with the resistance = zero.

Measurement Range (without compensation of the leads)	0.00* to 10.00Ω	0.0* to 100.0Ω
Resolution	10mΩ	100mΩ
Accuracy	± (2% + 2 ct)	
Test Current	200mA	20mA
Open Voltage	≥ 6V	

**In the case of incorrect compensation of the leads, the instrument allows display of negative values, down to -0.05Ω at 200A and -0.5Ω at 20mA.*

Test Current

200mA range: 200mA (0mA + 20mA)

20mA range: 20mA ± 5mA

Measurement Range	0 to 250mA
--------------------------	-------------------

Resolution	1mA
Accuracy	± (2% + 2 ct)

Compensation of the Leads: 0 to 9.99Ω.

3.2.4 Resistance Measurement

Measurement Range	0 to 3999Ω	4.00 to 39.99kΩ	40.0 to 399.9kΩ	400 to 1000kΩ
Resolution	1Ω	10Ω	100Ω	1kΩ
Accuracy	± (3% + 2 ct)			
Open voltage	approximately 4.5V			

3.2.5 Timer

Measurement Range	0:00 to 39:59
Resolution	1s
Accuracy	± 1s

3.2.6 Floor Resistance Testing

The two floor weights that come with the floor testing kit comply with the ESD protection standards IEC 61340-2-3 and IEC 61340-4-1.

3.3 Operating Environment

3.3.1 Voltage Measurement

Influencing Parameter	Range of influence	Quantity influenced	Influence	
			Typical	Maximum
Temperature	20 to + 55°C (-4 to 131°F)	V, F		0.3% R/10°C + 1 ct (0.3% R/18°F + 1 ct)
Relative humidity	20 to 80% RH	V, F		1% R + 2 ct
Frequency	15.3 to 800Hz	V	1%	2% R + 1 ct

Supply voltage	6.6 to 9.6V	V, F		0.1% R + 2 ct
Common mode rejection in AC 50/60 Hz	0 to 600V _{AC}	V	50dB	40dB

3.3.2 Insulation Measurement

Influencing Parameter	Range of Influence	Quantity Influenced	Influence	
			Typical	Maximum
Temperature	-20 to + 55°C (-4 to 131°F)	MΩ R ≤ 3GΩ 3GΩ < R < 10GΩ 10GΩ ≤ R	1% R/10°C + 1pt	2% R/10°C + 2 ct 3% R/10°C + 2 ct 4% R/10°C + 2 ct
		V _T : 10 to 100V		0.5% R/10°C + 1 ct
		Measurement current	1% R/10°C + 1 ct	2% R/10°C + 2 ct
Relative humidity	20 to 80% RH	MΩ	2% R + 1 ct	3% R + 2 ct
		V _T : 50 to 100V		1% R + 2 ct
		Measurement current		1% R + 2 ct
Supply voltage	6.6 to 9.6V	MΩ		0.1% R + 2 ct
50/60Hz AC voltage superposed on the test voltage (V _T)		V_T = 10V: R ≤ 0.1GΩ : 10V from 0.1 to 0.3GΩ : 0.2V		5% R + 2 ct
		V_T = 25V: R ≤ 0.1GΩ : 10V from 0.1 to 0.5GΩ : 0.2V		
		V_T = 50V: R ≤ 0.1GΩ : 4V from 0.1 to 1GΩ : 0.2V		
		V_T = 100V: from 100kΩ to 10MΩ : 20V from 10MΩ to 1 GΩ : 0.3V		

Capacitance in parallel on resistance to be measured	0 to 5 μ F at 1mA	M Ω		1% R + 1 ct
	0 to 2 μ F	V_T = 10V and 25V from 10k Ω to 1 G Ω	2% R + 1 ct	3% R + 2 ct
		V_T = 50V and 100V from 10k Ω to 3 G Ω	6% R + 2 ct	10% R + 2 ct
	0 to 1 μ F	V_T = 50V \leq 5G Ω	6% R + 2 ct	10% R + 2 ct
Common mode rejection in AC 50/60 Hz	0 to 600VAC	V	50dB	40dB

3.3.3 Resistance and Continuity Measurement

Influencing Parameter	Range of Influence	Quantity Influenced	Influence	
			Typical	Maximum
Temperature	-20 to + 55°C (-4 to 131°F)	at 200mA		2% R/10°C + 2 ct
		at 20mA		2% R/10°C + 2 ct
		R		1% R/10°C + 2 ct
Relative humidity	20 to 80% RH	at 200mA		4% R + 2 ct
		at 20mA		4% R + 2 ct
		R		3% R + 2 ct
Supply voltage	6.6 to 9.6V	at 200mA at 20mA R		0.1% R + 2 ct
50/60Hz AC voltage superposed on the test voltage (V _T)	0.5VAC	at 200mA		5% R + 10 ct
	For R \geq 10 Ω : 0.4VAC	at 20mA		
	Accepts no perturbations	R		
Common mode rejection in AC 50/60 Hz	0 to 600VAC	at 200mA at 20mA R	50dB	40dB

3.3.4 Intrinsic Uncertainty and Operating Uncertainty

These megohmmeters comply with standard IEC 61557, which requires that the operating uncertainty (called B) must be less than 30%.

In insulation and continuity measurements:

$$B = \pm(|A| + 1.15 \sqrt{E_1^2 + E_2^2 + E_3^2})$$

where:

A = intrinsic uncertainty

E₁ = influence of the reference position ± 90°

E₂ = influence of the supply voltage within the limits indicated by the manufacturer

E₃ = influence of the temperature between 0 and 35°C (32 and 95°F)

3.4 Power Supply

The instrument is powered by six 1.5V alkaline AA (LR6) batteries.

The voltage range ensuring correct operation is from 6.6V to 9.6V.

Typical life between charges:

- Insulation: 6000 5-second measurements at 100V for R = 100kΩ, at the rate of one measurement per minute
- Continuity: 3000 5-second measurements, at the rate of one measurement per minute

3.5 Environmental Conditions

Indoor use

Range of operation: -20 to +55°C (-4 to 131°F) and 20 to 80% RH

Range of storage (without batteries): -30 to +80°C (-22 to 176°F) and 10 to 90% RH without condensation

Altitude: <2000m (6562ft)

Degree of pollution: 2

3.6 Mechanical Specifications

Dimensions (L x W x H): 211 x 108 x 60mm (8.31 x 4.25 x 2.36")

Weight: approximately 850g (1.87lb)

Ingress protection:

- IP 54 per IEC 60529, not in operation
- IK 04 per IEC 50102

Drop test: per IEC 61010-1

3.7 Safety Standards

Safety according to: EN 61010-2-30 : 2010

Insulation Class: 2

Pollution Degree: 2

Overvoltage Category: 600V CAT IV

Immunity according to: EN 61326-1 : 2013

Emission according to: EN 61326-1 : 2013

Specifications are subject to change without notice.

4. MAINTENANCE & TROUBLESHOOTING

 Except for the batteries, the instrument contains no parts that can be replaced by personnel who have not been specially trained and accredited. Any unauthorized repair or replacement of a part by an “equivalent” may impair safety.

4.1 Maintenance

4.1.1 Cleaning

Disconnect the unit completely and turn the rotary switch to OFF.

Use a soft cloth, dampened with soapy water. Rinse with a damp cloth and dry rapidly with a dry cloth or forced air. Do not use alcohol, solvents, or hydrocarbons.

Do not use the instrument again until it is completely dry.

4.1.2 Replacing the Batteries

At start-up, the instrument displays the remaining battery life:

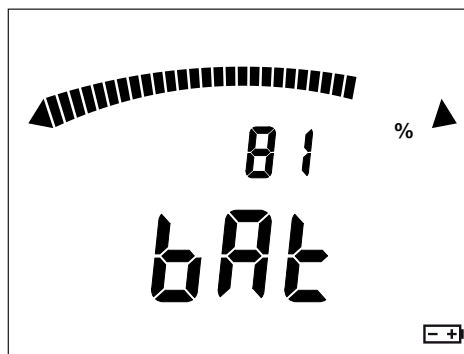

If the battery voltage is too low to ensure correct operation of the instrument, a “low battery” message appears on the LCD and the  symbol blinks:



This indicates the batteries must be replaced. All batteries must be replaced at the same time. To do this:

1. Disconnect any attached leads or accessories from the instrument and turn the rotary switch to OFF.
2. Use a tool or a coin to turn the quarter-turn screw of the battery compartment cover.
3. Remove the battery compartment cover.
4. Remove the batteries from the compartment.

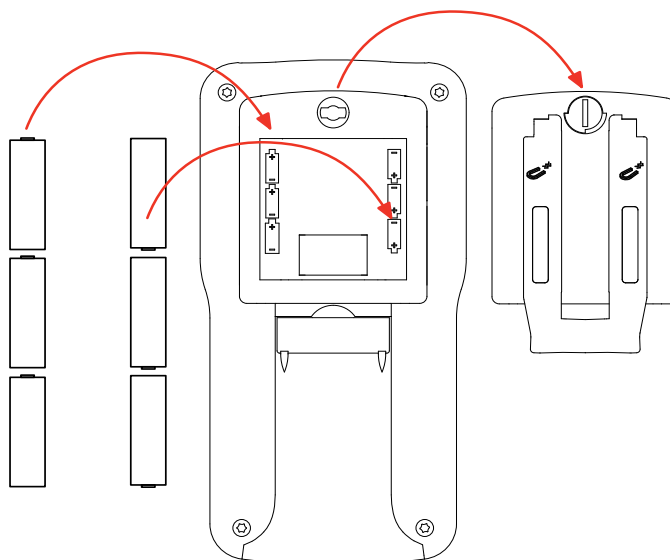

Do not treat spent batteries as ordinary household waste. Take them to the appropriate collection facility for recycling.

5. Place the new batteries in the compartment, ensuring that each battery's polarity is correct.
6. Put the battery compartment cover in place and screw the quarter-turn screw back in.

4.2 Troubleshooting

4.2.1 Errors

During instrument operation, errors may be displayed on the LCD. The causes of any errors must be corrected before the instrument can resume normal operation.

4.2.1.1 Voltage present before an insulation measurement

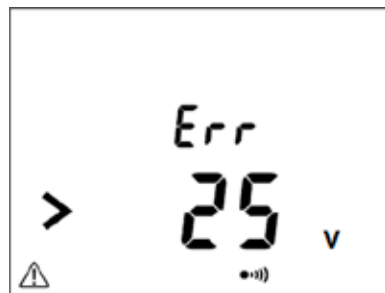

Before taking an insulation measurement, the instrument measures voltage on the system under test. If it detects voltage in excess of 25V and you attempt to take a measurement, the instrument displays the message shown to the left, and no measurement is taken.

You must eliminate the voltage to resume taking the measurement.

4.2.1.2 Range exceeded during an insulation measurement



If during an insulation measurement the value to be measured exceeds the measurement range (which depends on the test voltage), the instrument reports this condition. For example, the screen to the left is displayed when the range is exceeded while measuring in the 100V range.

4.2.1.3 Voltage present during a continuity or resistance measurement

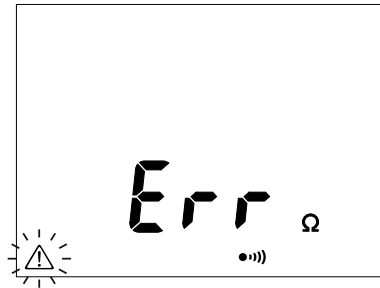

If during a continuity or resistance measurement the instrument detects an external voltage in excess of 15V (AC or DC), it interrupts the measurement and displays the screen show to the left.

You must eliminate the voltage to resume the measurement.

4.2.2 Resetting the Instrument

You can reset your instrument at any time. To do this:

1. Press the ▲ and ☀ buttons simultaneously.
2. Turn the rotary switch to any setting other than OFF.
3. The instrument reboots.

4.5 Limited Warranty

The Model 6536 is warranted to the owner for a period of one year from the date of original purchase against defects in manufacture. This limited warranty is given by AEMC® Instruments, not by the distributor from whom it was purchased. This warranty is void if the unit has been tampered with or abused, or if the defect is related to service not performed by AEMC® Instruments.

Please print the online Warranty Coverage Information for your records.

What AEMC® Instruments will do: If a malfunction occurs within the one-year period, you may return the instrument to us for repair, provided we have your warranty registration information on file or a proof of purchase. AEMC® Instruments will, at its option, repair or replace the faulty material.

4.6 Warranty Repairs

What you must do to return an Instrument for Warranty Repair:

First, request a Customer Service Authorization Number (CSA#) by phone or by fax from our Service Department (see address below), then return the instrument along with the signed CSA Form. Please write the CSA# on the outside of the shipping container. Return the instrument, postage or shipment pre-paid to:

Caution: To protect yourself against in-transit loss, we recommend you insure your returned material.

NOTE: You must obtain a CSA# before returning any instrument.