

▪ POWER CLAMP-ON METER

607



ENGLISH

User Manual



0.561.8187

www.itm.com

information@itm.

## Statement of Compliance

Chauvin Arnoux<sup>®</sup>, Inc. d.b.a. AEMC<sup>®</sup> Instruments certifies that this instrument has been calibrated using standards and instruments traceable to international standards.

We guarantee that at the time of shipping your instrument has met its published specifications.

An N.I.S.T. traceable certificate may be requested at the time of purchase, or obtained by returning the instrument to our repair and calibration facility, for a nominal charge.

The recommended calibration interval for this instrument is 12 months and begins on the date of receipt by the customer. For recalibration, please use our calibration services. Refer to our repair and calibration section at [www.aemc.com](http://www.aemc.com).

**Serial #:** \_\_\_\_\_

**Catalog #:** 2139.61 \_\_\_\_\_

**Model #:** 607 \_\_\_\_\_

Please fill in the appropriate date as indicated:













Date Received: \_\_\_\_\_

Date Calibration Due: \_\_\_\_\_



Chauvin Arnoux<sup>®</sup>, Inc.  
d.b.a AEMC<sup>®</sup> Instruments  
[www.aemc.com](http://www.aemc.com)

# CONTENTS

PRECAUTIONS FOR USE .....	7
MEASUREMENT CATEGORIES .....	8
RECEIVING YOUR SHIPMENT .....	8
ORDERING INFORMATION .....	8
<b>1 PRESENTATION .....</b>	<b>9</b>
1.1 ROTARY SWITCH .....	10
1.2 FUNCTION BUTTONS .....	11
1.3 DISPLAY .....	12
1.3.1 Display Symbols .....	12
1.3.2 Measurement Capacity Exceeded (OL) .....	13
1.4 TERMINALS .....	13
<b>2 BUTTONS .....</b>	<b>14</b>
2.1  BUTTON .....	14
2.2  (YELLOW) BUTTON (second function) .....	15
2.3  BUTTON .....	15
2.4  BUTTON .....	16
2.5  BUTTON .....	16
2.5.1 Normal Mode .....	16
2.5.2 MAX/MIN Mode + HOLD Mode .....	17
2.5.3 True Inrush <sup>®</sup> Mode (  set switch to  ) .....	18
2.6  BUTTON .....	18
2.6.1 Normal Mode .....	19
2.6.2 Harmonic Order Display  or  +  .....	19
2.6.3 Hz Function + HOLD Mode .....	19
<b>3 USE .....</b>	<b>20</b>
3.1 BATTERY INSTALLATION .....	20
3.2 TURNING ON THE METER .....	20
3.3 TURNING OFF THE METER .....	20
3.4 CONFIGURATION .....	21
3.4.1 Auto Power Off .....	21
3.4.2 Current Threshold for True InRush <sup>®</sup> .....	21
3.4.3 Recording Duration .....	22
3.4.4 Erasing Memory .....	22
3.4.5 Default Configuration .....	22
3.5 VOLTAGE MEASUREMENT (V) .....	23
3.6 CONTINUITY TEST  .....	24
3.7 RESISTANCE MEASUREMENT $\Omega$ .....	25











3.8	CURRENT MEASUREMENT (A)	25
3.8.1	AC Measurement	25
3.8.2	DC or AC+DC Measurement	26
3.9	CURRENT OR OVERCURRENT (True InRush <sup>®</sup> ) MEASUREMENT	28
3.10	POWER MEASUREMENTS W, VA, var AND PF	30
3.10.1	Single-Phase Power Measurement	30
3.10.2	Balanced 3-Phase Power Measurement	31
3.10.3	Four Quadrant Diagram	32
3.11	ENERGY METERING MEASUREMENT	33
3.12	FREQUENCY MEASUREMENT (Hz)	36
3.12.1	Frequency Measurement (V)	36
3.12.2	Frequency Measurement (A)	37
3.13	THD AND DISPLAY OF HARMONICS ORDER	37
3.13.1	THD (V)	37
3.13.2	THD (A)	38
3.13.3	Individual Harmonics & Frequency Of Fundamental	39
3.14	RECORDING MEASUREMENTS	40
3.15	CONNECTING TO A COMPUTER	40
3.15.1	Bluetooth Connection	40
3.15.2	Pairing the Instrument to the Computer	41
3.16	TURNING BLUETOOTH ON/OFF	41
3.17	RECORDING DATA	42
3.17.1	Starting a Recording Session	42
3.17.2	Stopping a Recording Session	42
3.18	DOWNLOADING RECORDED DATA	42
3.19	ERASING DATA FROM MEMORY	42
3.20	DATA STORAGE	43
3.20.1	Trend Measurements	43
3.20.2	Recording with Memory Cleared	43
3.20.3	Recording with a Partial or Full Memory	43
3.20.4	Memory Filled During Recording Session	43
3.21	DATAVIEW <sup>®</sup> SOFTWARE INSTALLATION	43
3.22	OPENING THE CONTROL PANEL	44
3.23	USING THE CONTROL PANEL	44
<b>4</b>	<b>SPECIFICATIONS</b>	<b>45</b>
4.1	REFERENCE CONDITIONS	45
4.2	SPECIFICATIONS UNDER THE REFERENCE CONDITIONS	45
4.2.1	DC Voltage Measurement	45
4.2.2	AC Voltage Measurement	46
4.2.3	AC+DC Voltage Measurement	46
4.2.4	DC Current Measurement	47
4.2.5	AC Current Measurement	47
4.2.6	AC+DC Intensity Measurement	48
4.2.7	True InRush <sup>®</sup> Measurement	48
4.2.8	Crest Factor (CF) Calculation	49
4.2.9	RIPPLE in DC Calculation	49
4.2.10	Continuity Measurement	49
4.2.11	Resistance Measurement	49
4.2.12	Active DC Power Measurement	50

4.2.13	Active AC Power Measurement .....	50
4.2.14	Active AC+DC Power Measurement .....	52
4.2.15	Apparent AC Power Measurement .....	52
4.2.16	Apparent AC+DC Power Measurement .....	53
4.2.17	Reactive AC Power Measurement .....	53
4.2.18	Reactive AC+DC Power Measurement .....	54
4.2.19	Power Factor (PF) Calculation .....	54
4.2.20	Displacement Power Factor (DPF) Calculation .....	55
4.2.21	Frequency Measurements .....	55
4.2.22	THDr Specifications .....	56
4.2.23	THDf Specifications .....	56
4.2.24	Harmonic Measurement Specifications .....	56
4.3	ENVIRONMENTAL CONDITIONS .....	57
4.4	MECHANICAL SPECIFICATIONS .....	57
4.5	POWER SUPPLY .....	57
4.6	COMPLIANCE WITH INTERNATIONAL STANDARDS .....	57
4.7	ENVIRONMENTAL VARIATIONS .....	58
<b>5</b>	<b>MAINTENANCE .....</b>	<b>59</b>
5.1	WARNING: .....	59
5.2	CLEANING .....	59
5.3	BATTERY REPLACEMENT .....	59
<b>6</b>	<b>REPAIR AND CALIBRATION .....</b>	<b>60</b>
<b>7</b>	<b>TECHNICAL AND SALES ASSISTANCE .....</b>	<b>60</b>
<b>8</b>	<b>LIMITED WARRANTY .....</b>	<b>61</b>
<b>9</b>	<b>WARRANTY REPAIRS .....</b>	<b>61</b>

Thank you for purchasing the **Clamp-on Meter Model 607**.

For best results from your instrument and for your safety, read the following operating instructions carefully and comply with the precautions for use. This instrument must be only used by qualified and trained users.

### Symbols used on the instrument

	<b>CAUTION - Risk of Danger!</b> Indicates a WARNING. Refer to this user manual for instructions before operating the instrument in all cases where this symbol is marked.
	Risk of electric shock. The voltage at the parts marked with this symbol may be dangerous.
	Refers to a type A current sensor. This symbol signifies that application around and removal from HAZARDOUS LIVE conductors is permitted.
	1.5 V battery.
	Indicates compliance with European directives.
	Double insulation or reinforced insulation.
	In the European Union, this product is subject to a separate collection system for recycling electrical and electronic components In accordance with directive WEEE 2002/96/EC.
	AC – Alternating current.
	AC and DC – Alternating and direct current.
	Ground/Earth.

# PRECAUTIONS FOR USE

This instrument complies with safety standards IEC-61010-1 and 61010-2-032 for voltages of 1000V in category IV at an altitude of less than 6500' (2000m), indoors, with a degree of pollution not exceeding 2.

These safety instructions are intended to ensure the safety of persons and proper operation of the device.

- The operator and/or the responsible authority must carefully read and clearly understand the various precautions to be taken in use.
- If this instrument is used other than as specified, the protection it provides may be compromised, thereby endangering you.
- Do not use the instrument in an explosive atmosphere or in the presence of flammable gases or fumes.
- Do not use the instrument on networks of which the voltage or category exceeds those mentioned.
- Do not exceed the rated maximum voltages and currents between terminals or with respect to earth.
- Do not use the instrument if it appears to be damaged, incomplete, or not properly closed.
- Before each use, check the condition of the insulation on the leads, housing, and accessories. Any element of which the insulation is deteriorated (even partially) must be set aside for repair or scrapped.
- Use leads and accessories rated for voltages and categories at least equal to those of the instrument. If not, an accessory of a lower category lowers the category of the combined clamp + accessory to that of the accessory.
- Observe the environmental conditions of use.
- Do not modify the instrument and only use factory replacement parts. Repairs and adjustments must be done by approved qualified personnel.
- Replace the batteries as soon as the  symbol appears on the display of the unit. Disconnect all leads before opening the battery compartment cover.
- Use personal protective equipment when conditions require.
- Keep your hands away from the unused terminals of the instrument.
- When handling the test probes, alligator clips, and clamp ammeters, keep your fingers behind the physical guard.
- As a safety measure, and to avoid repeated overloads on the inputs of the device, configuration operations should only be performed when the device is disconnected from all dangerous voltages.

# MEASUREMENT CATEGORIES

## Definitions of the measurement categories:

**CAT IV:** Circuits supplying the low-voltage installation of the building.

*Example: power lines, meters, and protection devices.*

**CAT III:** Power supply circuits in the installation of the building.

*Example: distribution panel, circuit-breakers, fixed industrial machines or devices.*

**CAT II:** Circuits directly connected to the low-voltage installation.

*Example: power supply to household electrical appliances and portable tools.*

# RECEIVING YOUR SHIPMENT

Upon receiving your shipment, make sure that the contents are consistent with the packing list. Notify your distributor of any missing items. If the equipment appears to be damaged, file a claim immediately with the carrier and notify your distributor at once, giving a detailed description of any damage. Save the damaged packing container to substantiate your claim.

# ORDERING INFORMATION

**Clamp-on Meter Model 607** ..... **Cat. #2139.61**

*Includes set of 2 color-coded silicone insulated test leads, test probes and alligator clips, hard carrying case, 4x1.5V AA batteries, Bluetooth adapter, safety information sheet and a USB drive containing product user manual and DataView® software.*

## Replacement Parts:

Hard Carrying Case ..... **Cat. #2139.73**

Set of 2 Color-coded Silicone Test Leads, Test Probes  
and Alligator Clips ..... **Cat. #2152.05**

Set of 2 Color-coded Silicone Test Leads (Red/Black) 5' ..... **Cat. #2152.15**

Clip – Safety Alligator - Black ..... **Cat. #2140.53**

Clip – Safety Alligator - Red ..... **Cat. #2140.52**

Black Test Probe ..... **Cat. #5000.30**

Red Test Probe ..... **Cat. #5000.31**



# 1 PRESENTATION

The Clamp-on Meter Model 607 is a 10,000-count professional electrical measuring instrument that combines the following functions:

- Current measurement
- InRush current / overcurrent (True InRush<sup>®</sup>) measurement
- Voltage measurement
- Frequency measurement
- Harmonic distortion (THD) measurement
- Harmonic rank value (A and V) up to the 25th
- Continuity test with buzzer
- Resistance measurement
- Power (W, VA, var and PF) and Energy measurements
- Crest Factor (CF), the Displacement Power Factor (DPF) and RIPPLE measurement
- Recording of data in memory; wireless transfer via Bluetooth to a PC



Item	Description	See §
1	Jaws with centering marks	3.5 to 3.13
2	Physical guard	-
3	Rotary function switch	1.1
4	Function buttons	2
5	Backlit display	1.3
6	Input terminals	1.4
7	Trigger for opening jaws	-

Figure 1: Clamp-on Meter Model 607

## 1.1 ROTARY SWITCH

The rotary switch has five positions. To access the  $V_{\sim}$ ,  $\Omega$ ,  $A_{\sim}$ ,  $W_{\sim}$  functions, set the switch to the desired function. The functions are described in the table below.

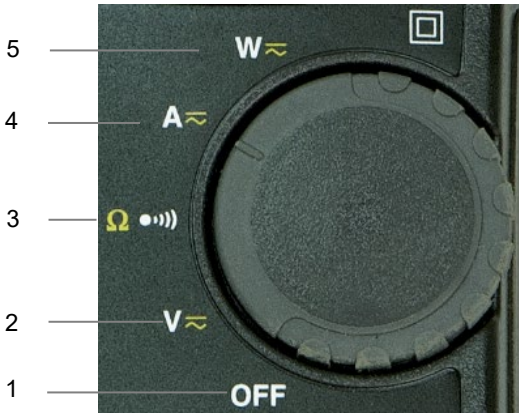

**Figure 2: Function Rotary Switch**

Item	Function	See §
1	OFF mode – Turns the clamp-on meter off	3.3
2	AC, DC, AC+DC voltage measurement (V)	3.5
3	Continuity test $\bullet\)))$ Resistance measurement $\Omega$	3.6 3.7
4	AC, DC, AC+DC current measurement (A)	3.8
5	Power measurements (W, var, VA) AC, DC, AC+ DC Power factor (PF), displacement power factor (DPF), and energy calculation	3.10

## 1.2 FUNCTION BUTTONS



**Figure 3: Function Buttons**

Item	Function	See §
1	Holds the last value on the display Zero correction $A_{DC}/A_{AC+DC}/W_{DC}/W_{AC+DC}$	2.1 3.8.2
2	Selects the type of measurement and configuration functions (AC, DC, AC+DC) Selection of single-phase or 3-phase measurement	2.2
3	Enables/disables display backlighting Scrolls up the of orders of harmonics or of pages of results in W, MAX/MIN/PEAK Enables/disables Bluetooth wireless transfer (in combination with 6 below))	2.3
4	Enables/disables the MAX/MIN/PEAK mode Enables/disables the True InRush <sup>®</sup> mode in A	2.5
5	Measures frequency (Hz), total harmonic distortion (THD), and orders of harmonics Enables/disables the energy metering mode	2.6
6	Scrolls down the orders of harmonics or of pages of results in W, MAX/MIN/PEAK Enables/disables recording of current data in memory Enables/disables Bluetooth wireless transfer (in combination with 3)	2.4

### 1.3 DISPLAY

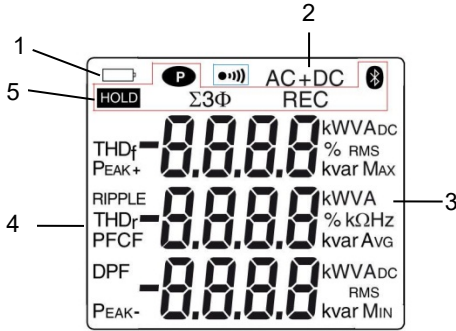





Figure 4: Display

Item	Function	See §
1	Low battery indication	5.2
2	Type of measurement (AC or DC)	2.2
3	Active measurement value and unit display	3.5 to 3.13
4	Display of the MAX/MIN/PEAK modes	3.10
5	Mode selection display	2

#### 1.3.1 Display Symbols

Symbol	Description
<b>AC</b>	Alternating current or voltage
<b>DC</b>	Direct current or voltage
<b>AC+DC</b>	Alternating and direct current
<b>HOLD</b>	Storage of the values and display hold
<b>RMS</b>	RMS value
<b>Max</b>	Maximum DC or RMS value
<b>Min</b>	Minimum DC or RMS value
<b>AVG</b>	Mean RMS value
<b>PEAK+</b>	Maximum peak value
<b>PEAK-</b>	Minimum peak value
$\Sigma 3\Phi$	Balanced total 3-phase power measurement
<b>V</b>	Volt
<b>Hz</b>	Hertz
<b>W</b>	Active power
<b>A</b>	Ampere
<b>%</b>	Percentage
<b>Ω</b>	Ohm

<b>m</b>	Milli- prefix
<b>k</b>	Kilo- prefix
<b>var</b>	Reactive power
<b>VA</b>	Apparent power
<b>PF</b>	Power factor
<b>DPF</b>	Displacement power factor ( $\cos \phi$ )
<b>CF</b>	Crest factor
<b>RIPPLE</b>	Ripple (in DC)
<b>THDf</b>	Total harmonic distortion with respect to the fundamental
<b>THDr</b>	Total harmonic distortion with respect to the true RMS value of the signal
<b>REC</b>	Recording in memory
	Bluetooth wireless communication
	Continuity test
	Auto power off disabled
	Low battery indicator

### 1.3.2 Measurement Capacity Exceeded (OL)

The **OL** (Over Load) symbol is displayed when the display capacity is exceeded.

## 1.4 TERMINALS

The terminals are used as follows:

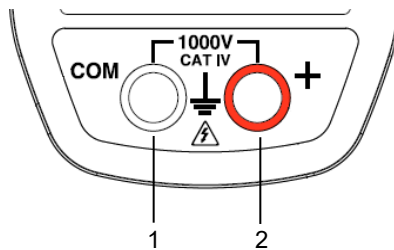

**Figure 5: Terminals**

Item	Function
1	<b>COM</b> (black) Input Terminal Jack
2	<b>+ Positive</b> (red) Input Terminal Jack

## 2 BUTTONS







The buttons respond differently to short, long, and sustained presses.



In this section, the  icon represents the possible positions of the switch for the button's functionality.

### 2.1 BUTTON

This button is used to:

- Store and look up the last values acquired specific to each function (V, A,  $\Omega$ , W) according to the specific modes previously activated (MAX/MIN/PEAK, Hz, THD). The present display is then maintained while the detection and acquisition of new values continues.
- Perform automatic zero correction in  $A_{DC/AC+DC}$  and  $W_{DC/AC+DC}$  (see § 3.9.2).

Successive presses on 		Function
	   	<b>First press:</b> Holds the last value displayed <b>Second press:</b> Returns to normal display mode (the value of each new measurement is displayed)
long (> 2 sec)	$A_{DC}$ $A_{AC+DC}$ $W_{DC}$ $W_{AC+DC}$	Performs automatic zero correction (see 3.9.2) <b>NOTE:</b> This mode operates if the MAX/MIN/PEAK or HOLD modes (short press) are first de activated









See § 2.5.3 and § 2.6.3 for the  button functionality in combination with the  and  buttons.

## 2.2 (YELLOW) BUTTON (SECOND FUNCTION)

This button is used to select the type of measurement (AC, DC, AC+DC) and the second functions marked in yellow next to the relevant positions of the switch.

It can also be used to modify the default values in configuration mode (see § 3.4).















**NOTE:** This button is invalid in the MAX/MIN/PEAK and HOLD modes.

Successive presses on 		Function
short	  	Selects AC, DC or AC+DC. Depending on your choice, the screen displays AC, DC or AC+DC.
		Toggles between continuity  and Ohm $\Omega$ modes.
long (>2 sec)		Displays the total 3-phase power of a balanced system ( $\Sigma 3\Phi$ is displayed). Press again to return to the display of the single-phase power ( $\Sigma 3\Phi$ is off).

## 2.3 BUTTON

This button is used to:















- Scroll up through the order of harmonics or successive pages
- Activate the backlighting
- Activate the Bluetooth function

Successive presses on 		Function
short	  	Scrolls through the various pages of measurement results, depending on the function and possibly the active mode (MAX/MIN/PEAK or THD/Harmonics)
long (> 2 sec)	   	Enables/disables the backlighting of the display <b>NOTE:</b> The backlight turns off automatically after 2 minutes
combined with the  button	   	- Activates Bluetooth wireless communication - The  symbol is displayed <b>NOTE:</b> Activation of Bluetooth mode automatically stops the recording of the data

## 2.4 BUTTON

This button is used to:

- Scroll down through the orders of harmonics or successive pages
- Activate data recording
- Activate the Bluetooth function

Successive presses on 		Function
short	  	- Scrolls through the various pages of measurement results, depending on the function and possibly the active mode (MAX/MIN/PEAK or THD/Harmonics)
long (> 2 sec)	   	- Enables/disables the recording of the data - The <b>REC</b> symbol is then displayed <b>NOTE:</b> When the recording memory is full, the REC symbol flashes
combined with the  button	   	- Activates Bluetooth wireless communication - The  symbol is displayed <b>NOTE:</b> Activation of Bluetooth mode automatically stops the recording of the data

## 2.5 BUTTON











### 2.5.1 Normal Mode

This button activates the detection of the MAX, MIN, PEAK+, PEAK- or AVG values of the measurements made.









Max and Min are the extreme mean values in DC and the extreme RMS values in AC. Peak+ is the maximum instantaneous peak and Peak- is the minimum instantaneous peak.

**NOTE:** In this mode, the Auto Power Off function of the device is automatically disabled. The  symbol is displayed on the screen.



Successive presses on 		Function
short	 	<p><b>First press:</b> Activates detection of the MAX/MIN/AVG and PEAK values and displays MAX/AVG and MIN values.</p> <p><b>Second press:</b> Displays the PEAK+, AVG, and PEAK- values (on a second screen).</p> <p><b>Third press:</b> Displays MAX/AVG and MIN values without exiting from the mode (the values already detected are not erased).</p> <p><b>NOTE:</b> Depending on the mode, AC or DC, the crest factor (CF), harmonics, frequency, and RIPPLE are also available.</p>
	 	<ul style="list-style-type: none"> <li>- Activates the detection of MAX/MIN/AVG values</li> <li>- Displays the MAX, MIN and AVG value successively.</li> <li>- Returns to the display of the present measurement without exiting from the mode (the values already detected are not erased).</li> </ul>
long (> 2 sec)	   	<ul style="list-style-type: none"> <li>- Exits the MAX/MIN/PEAK mode. The values previously recorded are then erased.</li> </ul> <p><b>NOTE:</b> If the HOLD function is enabled, it is not possible to exit from the MAX/MIN/PEAK mode. The HOLD function must first be disabled first.</p>





## 2.5.2 MAX/MIN Mode + HOLD Mode

Successive presses on 		Function
short	   	<ul style="list-style-type: none"> <li>- Displays the MAX, AVG, MIN and PEAK+, AVG, PEAK- values detected before the  button was pressed.</li> <li>- When the  button is pressed, the last value is held on the display.</li> </ul>

**NOTE:** The HOLD function does not interrupt the acquisition of new MAX, MIN, PEAK values.

### 2.5.3 True InRush® Mode ( set switch to )

This button allows measurement of the True InRush® current (starting current, or overcurrent in steady-state operation) for AC or DC current only (not operational in AC+DC).











Successive presses on 		Function
long (>2 sec)		<ul style="list-style-type: none"> <li>- <b>First press:</b> Enters the True InRush® mode</li> <li>- "Inrh" is displayed for 3s (the backlighting blinks)</li> <li>- The triggering threshold is displayed for 5s (the backlighting is steady)</li> <li>- "-----" is displayed and the "A" symbol flashes (backlighting turns off)</li> <li>- After detection and acquisition, the InRush current measurement is displayed, after the calculations stage "-----" (backlighting off)</li> </ul> <p><b>NOTE:</b> The A symbol flashes to indicate "surveillance" of the signal</p> <ul style="list-style-type: none"> <li>- <b>Second press:</b> Exits the True InRush® mode (returns to simple current measurement)</li> </ul>
short (<2 sec)  <b>Note:</b> A short press is functional only if a True InRush value has been detected.		<ul style="list-style-type: none"> <li>- Displays the PEAK+ value of the current</li> <li>- Displays the PEAK- value of the current</li> <li>- Displays the RMS True InRush® current</li> </ul> <p><b>NOTE:</b> The A symbol is displayed during this sequence</p>

### 2.6 BUTTON







This button is used to display the frequency measurements of a signal, of power, of the levels and orders of harmonics.

**NOTE:** This button is not functional in the DC mode.





### 2.6.1 Normal Mode

Successive presses on 		Function
short	 	<p>Displays:</p> <ul style="list-style-type: none"> <li>- The frequency of the signal, the RMS measurement, and the DC component.</li> <li>- The crest factor CF, the RMS measurement, and the DC component.</li> </ul>
long (>2 sec)	 	<ul style="list-style-type: none"> <li>- Enters or exits the THD calculation and display mode.</li> <li>- Displays the THDf, the THDr, and the RMS value.</li> <li>- The  and  buttons are used to display each order of harmonic (25 orders, from h01 to h25), with the associated harmonic distortion (with respect to the fundamental) and the RMS value of order hxx.</li> <li>- <b>NOTE:</b> Order hdC (displayed in the DC and AC+DC modes) is the DC component; order h01 is the fundamental.</li> </ul>
		<ul style="list-style-type: none"> <li>- Starts/Stops the energy metering mode.</li> <li>- Displays the various energy parameters.</li> <li>- The  and  buttons are used to display the status and energy metering measurement results pages.</li> </ul>

### 2.6.2 Harmonic Order Display or +

Successive presses on 		Function
short	 	<ul style="list-style-type: none"> <li>- <b>First press:</b> Displays the frequency of the harmonic order previously selected using the  or  buttons, instead of order hxx.</li> <li>- <b>Second press:</b> Restores the display of order (hxx or hdC).</li> </ul>

### 2.6.3 Hz Function + HOLD Mode

Successive presses on 		Function
short	 	<ul style="list-style-type: none"> <li>- Stores and displays the frequency with the RMS value and the DC component, then on a 2nd consecutive page, the crest factor CF.</li> <li>- <b>NOTE:</b> The values displayed are those measured before the  button is pressed.</li> </ul>

## 3 USE

### 3.1 BATTERY INSTALLATION

Insert the batteries supplied with the device as follows:

1. Using a screwdriver, unscrew the battery compartment cover (item 1) from the back of the housing.
2. Insert the 4x1.5V AA batteries supplied (item 2), observing polarities.
3. Close the battery compartment cover and screw it onto the housing.

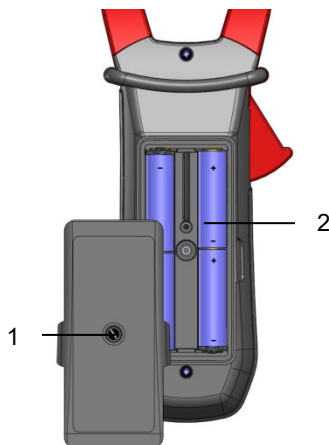

**Figure 6 : Battery Compartment**

### 3.2 TURNING ON THE INSTRUMENT

- With the rotary switch set in the OFF position, turn the switch to the desired function. The display lights (all symbols) for a few seconds (see §1.3), then the selected function screen is displayed.
- The clamp-on meter is now ready to make measurements.

### 3.3 TURNING OFF THE INSTRUMENT

The clamp-on meter can be turned off in two ways:





- Manually - Turn the switch to the OFF position.
- Automatically - After ten minutes with no activity, the instrument will turn OFF. Thirty (30) seconds before the device is switched off, an audible signal sounds intermittently. To re-activate the device, press any button or turn the rotary switch.

## 3.4 CONFIGURATION

As a safety measure, and to avoid repeated overloads on the meter inputs, configuration should only be performed when the meter is disconnected from all dangerous voltages.





### 3.4.1 Auto Power Off

The Auto Power Off feature is enabled by default. To disable it, perform the following:

1. In the OFF position, hold the  button down while turning the switch to  until the "full screen" display ends and a beep is emitted. The  symbol is displayed.
2. When the  button is released, the device is in the voltmeter function in the normal mode.
3. To return to Auto Power Off, turn the meter OFF and then back ON again.

### 3.4.2 Current Threshold for True InRush<sup>®</sup> Measurement

To configure the triggering current threshold of the True InRush<sup>®</sup> measurement:

1. In the OFF position, hold the  button down while turning the switch to  until the "full screen" display ends and a beep is emitted. The display will indicate the percentage overshoot to apply to the measured current to determine the measurement triggering threshold.  
The value stored by default is 10%, representing 110% of the established current measured. The possible values are 5%, 10%, 20%, 50%, 70%, 100%, 150%, and 200%.
2. To change the threshold, press the  (yellow) button. The value flashes; each press on the  (yellow) button displays the next value. To record the chosen threshold, apply a long press (>2s) on the  (yellow) button. A confirmation beep is emitted.



To exit from the configuration mode, turn the switch to another setting. The chosen threshold is stored and a double beep is emitted.

**NOTE:** The starting (InRush) current measurement triggering threshold is fixed at 1% of the least sensitive range. This value is 1% of 99.99A or 1A. This threshold is not adjustable.

### 3.4.3 Recording Duration

1. In the OFF position, hold the  (yellow) button down while turning the switch to **W**, until the end of the "full screen" display and the emission of a beep, to enter the configuration mode. The display will then indicate the recording interval.

**NOTE:** The default value is 60 seconds. Possible values range from 1 second to 600 seconds (10 minutes).

2. To change the recording interval, press the  (yellow) button. The right-hand digit blinks. Each press on the  (yellow) button increments its value. To go to the next digit, apply a long press (>2s) to the  (yellow) button.
3. When the desired unit is displayed, turn the switch to another setting. The unit chosen is stored and a double beep is emitted.

### 3.4.4 Erasing Recordings from Memory



To erase a recording from memory, perform the following:

**NOTE:** Make sure there is no voltage on the input terminals.

1. In the OFF position, hold the  (yellow) button down while turning the switch to **W**.
2. The device emits a beep after erasing the records in memory. The "rSt" and "rEC" symbols are displayed.
3. The device then switches to normal continuity measurement.

### 3.4.5 Default Configuration

To reset the clamp-on meter to its default parameters (factory configuration):

1. In the OFF position, hold down the  (yellow) button while turning the switch to **A**, until the "full screen" display ends and a beep is emitted. The "rSt" symbol is displayed.
2. After 2 s, the clamp-on meter emits a double beep, then all of the digital symbols of the screen are displayed until the  (yellow) button is released. The default parameters are then restored:
  - Recording interval = 60 seconds
  - Continuity detection threshold = 40Ω
  - True InRush triggering threshold = 10%

### 3.5 VOLTAGE MEASUREMENT (V)

To measure voltage, proceed as follows:

1. Set the switch to **V<sub>~</sub>**.
2. Connect the black lead to the **COM** terminal and the red lead to the **+** terminal.
3. Connect the test probes or the alligator clips to the circuit to be measured. The device selects AC or DC automatically according to which measured value is larger. The AC or DC symbol displays blinking in auto detect mode.

To select AC, DC or AC+DC manually, press the **⏏** (yellow) button to toggle between them. The symbol corresponding to the choice will then display.

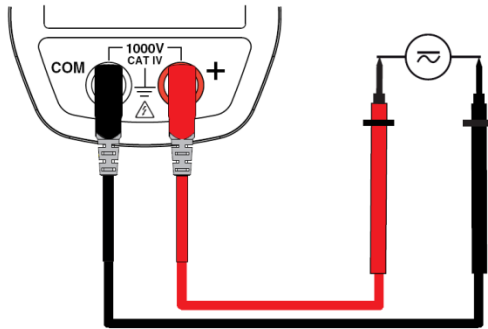

The measured value is displayed:

In DC

Display	Quantity
1 <sup>st</sup> row	Voltage V RMS
2 <sup>nd</sup> row	DC RIPPLE in %
3 <sup>rd</sup> row	DC voltage component, VDC

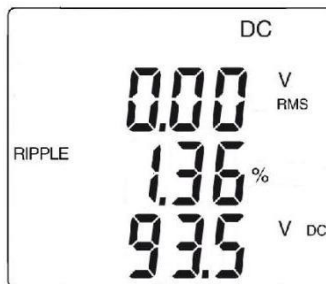

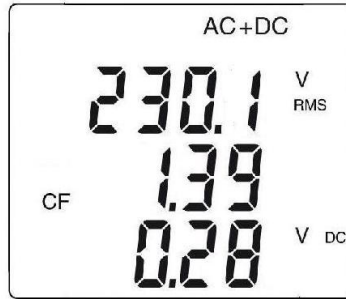

## In AC and AC+DC

Display	Quantity
1st row	Total RMS voltage V RMS or TRMS
2nd row	Crest factor (CF)
3rd row	DC voltage component, VDC



### 3.6 CONTINUITY TEST

**Warning:** Before performing the test, make sure that the circuit is off and all capacitors have been discharged.

1. Set the switch to . The  symbol is displayed.
2. Connect the black lead to the **COM** terminal and the red lead to the **+** terminal.
3. Connect the test probes or the alligator clips to the circuit or component to be measured.

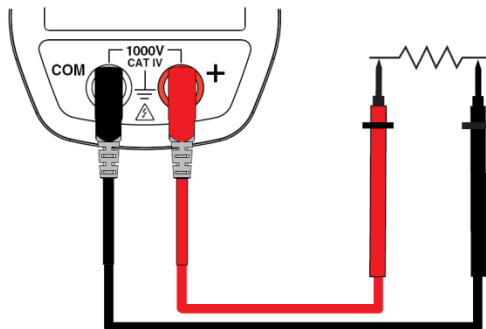



An audible signal is emitted if there is continuity and the measured value is displayed on the screen.



### 3.7 RESISTANCE MEASUREMENT $\Omega$

**Warning:** Before making a resistance measurement, make sure that the circuit is off and all capacitors have been discharged.

1. Set the switch to  and press the  (yellow) button. The  $\Omega$  symbol is displayed.
2. Connect the black lead to the **COM** terminal and the red lead to the **"+"** terminal.
3. Connect the test probes or the alligator clips to the circuit or component to be measured.

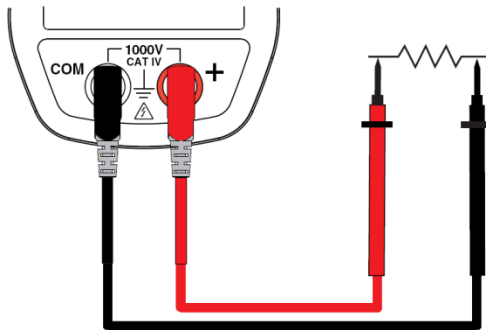

The measured value is displayed on the screen.

### 3.8 CURRENT MEASUREMENT (A)



The jaws are opened by pressing the trigger on the body of the meter. The arrow on the jaws of the clamp-on meter (see the following diagram) should point in the presumed direction of current flow, from the generator to the load. Make sure that the jaws have closed correctly after clamping around the conductor.

**NOTE:** The measurement results are optimal when the conductor is centered in the jaws (aligned with the centering marks).

The device selects AC or DC automatically according to which measured value is larger. The AC or DC symbol displays blinking in auto detect mode.

#### 3.8.1 AC Measurement

For an AC current measurement, proceed as follows:

1. Set the switch to  and select AC by pressing the  (yellow button). The AC symbol is displayed.
2. Clamp the jaws around the conductor to be measured. The device selects AC or DC automatically.

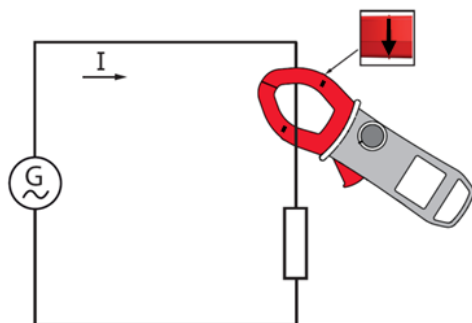

The measured values are displayed on the screen.

Display	Quantity
1st row	RMS current A RMS
2nd row	Crest factor (CF)
3rd row	DC current component A <sub>DC</sub>

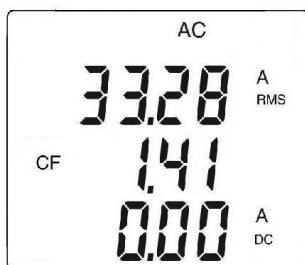

### 3.8.2 DC or AC+DC Measurement

Set the switch to **A<sub>AC</sub>** and select DC if the display does not indicate "0"; the DC zero must be corrected first.



#### Step 1: Correction of DC Zero

**Important:** The clamp must not be closed on the conductor during the DC zero correction. Hold the clamp in the same position during the whole procedure so that the correction value will be exact.

Press the **HOLD** button until the device emits a double beep and displays a value near "0". The correction value is stored until the clamp is powered down.

**NOTE:** The correction is effected only if the value displayed is  $< \pm 20A$ , otherwise the value displayed blinks and is not stored. The clamp must be recalibrated (see § 5.3).

## Step 2: Make a Measurement

1. The switch is set to . Select DC or AC+DC by pressing the  (yellow) button until the desired choice is reached.
2. Clamp the jaws around the conductor to be measured.

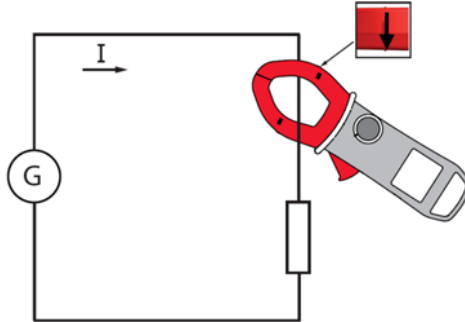

The measured values are displayed:

In DC:

Display	Quantity
1st row	Current A RMS
2nd row	DC RIPPLE in %
3rd row	DC current component A <sub>DC</sub>

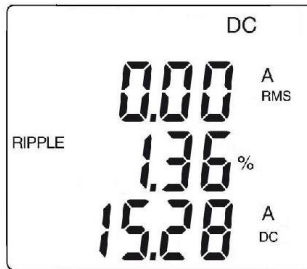

## In AC and AC+DC:

Display	Quantity
1st row	Total RMS current in A RMS or TRMS
2nd row	Crest factor (CF)
3rd row	DC current component Adc

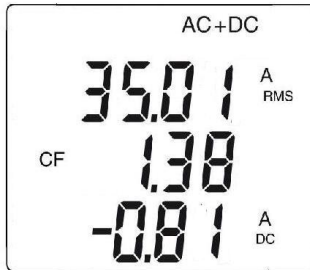

### 3.9 CURRENT OR OVERCURRENT (True InRush®) MEASUREMENT

**NOTE:** The measurement can be made only in AC or DC mode (AC+DC mode disabled).

To measure a starting current or overcurrent, proceed as follows:

1. Set the switch to **A**, correct the DC zero (see §3.8.2), then clamp the jaws around the conductor to be measured.
2. Perform a long press on the **MAX/MIN PEAK** button. The **InRh** symbol is displayed, along with the triggering threshold. The clamp then awaits detection of the True InRush® current. "-----" is displayed and the A symbol flashes.
3. After detection and acquisition for 100 ms, the RMS value of the True InRush® current is displayed. Pressing the **MAX/MIN PEAK** button will display the PEAK+/PEAK- values subsequently.
4. A long press on the **MAX/MIN PEAK** button or a change of function on the rotary switch will exit the True InRush® mode.

**NOTE:** The triggering threshold in A is 20A if the initial current is zero (starting of installation). For an established current (overload in an installation) see §3.4.2.

Display	Quantity
1st row	"Inrh"
2nd row	True Inrush value in A
3rd row	Triggering threshold in A

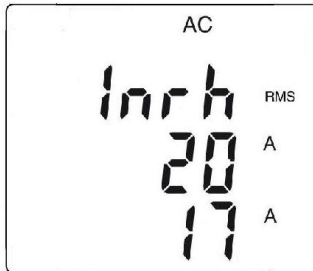

**PEAK:**

Display	Quantity
1st row	"Inrh"
2nd row	PEAK+ or PEAK- value in A
3rd row	Triggering threshold in A

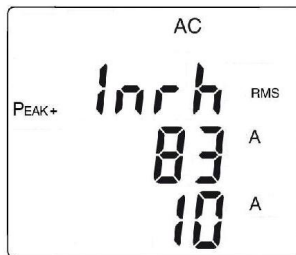

### 3.10 POWER MEASUREMENTS W, VA, VAR AND PF

This measurement is possible in single-phase or in balanced 3-phase.

**NOTE:** If performing DC or AC+DC power measurements, correct the DC zero in current first (see § 3.8.2)

For the power factor (PF) and VA and var, the measurements are only available in AC or AC+DC modes.

#### 3.10.1 Single-Phase Power Measurement

1. Set the switch to **W** and select **VA**, **var**, or **PF** by pressing the **Hz** button until the desired choice is reached.
2. The device automatically displays **AC+DC**. To select AC, DC, or AC+DC, press the **Yellow** (yellow button) until the desired choice is reached.
3. Connect the black lead to the **COM** terminal and the red lead to the **+** terminal.
4. Connect the test probes or the alligator clips of the black lead on the neutral (N), then those of the red lead on the L phase.
5. Clamp around only the corresponding conductor, respecting the direction.

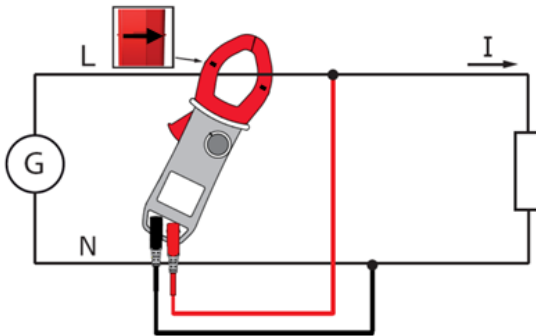

The measurement is displayed on screen.

Display	Quantity
1st row	Active power W (DC, AC or AC+DC)
2nd row	Reactive power var (AC or AC+DC)
3rd row	Apparent power VA (AC or AC+DC)

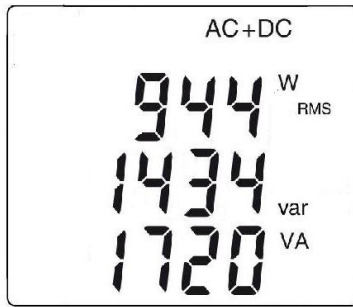

### 3.10.2 Balanced 3-Phase Power Measurement

1. Set the switch to **W<sub>~</sub>**.
2. Press the   (yellow) button until the  $\Sigma 3\Phi$  symbol is displayed.
3. The device automatically displays **AC+DC**. To select AC, DC, or AC+DC, press the   (yellow) button until the desired choice is reached.
4. Connect the black lead to the **COM** terminal and the red lead to the "+" terminal.
5. Connect the leads and the clamp to the circuit as follows:

If the red lead is connected to the...	...and the black lead is connected to the...	...then the clamp is on the conductor of the
L1 phase	L2 phase	L3 phase
L2 phase	L3 phase	L1 phase
L3 phase	L1 phase	L2 phase

**NOTE:** The arrow on the jaws of the clamp (see the diagram below) must point in the presumed direction of flow of the current from the source (producer) to the load (consumer).

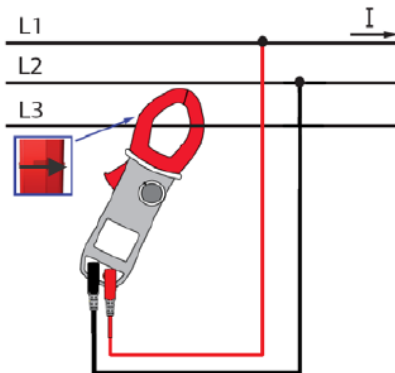

The measurement is displayed on screen.

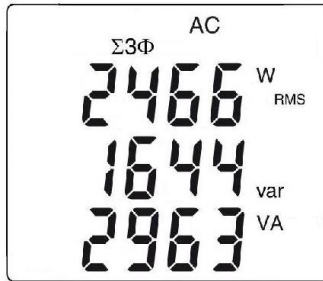

**NOTE:** 3-phase power on a balanced 4-wire network can also be measured by proceeding in the same way, or by proceeding as for the measurement on a single-phase network, then multiplying the value by three.

### 3.10.3 Four Quadrant Diagram

To correctly determine the sign of the active and reactive powers, refer to the diagram below, which determines:

- positive active power (W) = power consumed
- negative active power = power generated
- reactive power (var) and active power of the same sign = inductive power
- reactive power and active power of opposite signs = capacitive power

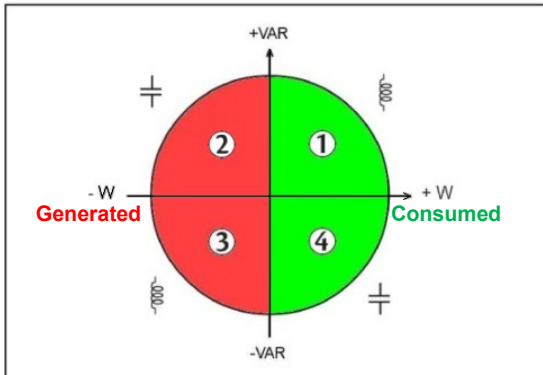



### 3.11 ENERGY METERING MEASUREMENT

The Energy Metering measurement is available in W for the AC and AC+DC quantities.

The energy meters start and totalize the various types of energy (the eight energy meters - 4 meters of energy consumed and 4 meters of energy generated - are started).

To measure the energy metering, proceed as follows:

1. Set the switch to **W** .
2. Press the **Hz** (long press). Start-up screen 1 in the Energy Metering mode appears. The display reads "Counting Off".



3. Connect the black lead to the **COM** terminal and the red lead to the "+" terminals.
4. Place the test probes or the alligator clips of the black lead on the neutral (N), then those of the red lead on the L phase.
5. Clamp around only the corresponding conductor, respecting the direction of current flow (see §3.10).
6. To start the metering, press the  (yellow) button. The display reads "Counting On".

The metering sequence is as follows:

|On--->Stop--->OFF--->|  
|----->|

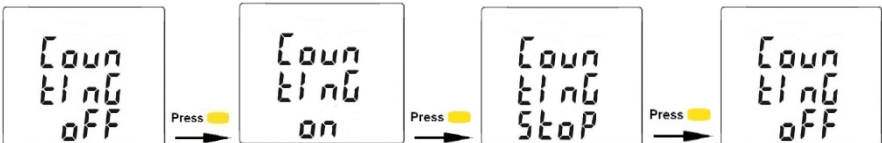

The status of each meter is:

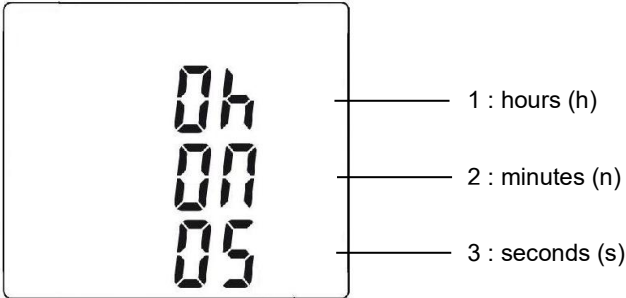

- On <=> metering in operation
- Off <=> metering stopped (values of the meters 0)
- Stop <=> metering stopped (values of the meters preserved)

Hour meter page:



The duration of the metering uses the following format: XXXh (for hours) XXm (for minutes) XXs (for seconds).

**NOTE:** Beyond 999h 59m 59s "---h--m--s" is displayed, but the internal metering duration keeps running correctly.

View of the set of screens concerning Energy measurement by short presses on  or  buttons:

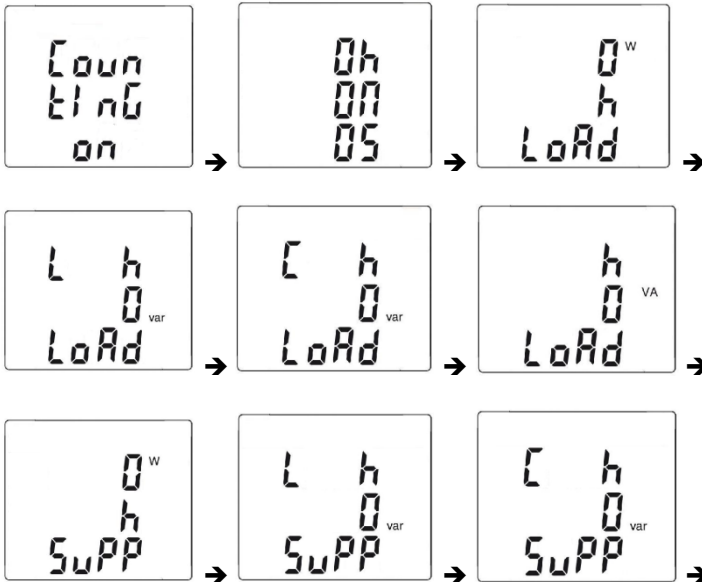

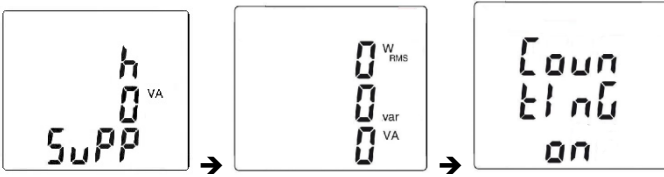

Conventions:

- Load:** consumed energy by the load (W+)
- Load C:** capacitive reactive energy (W+ and var-)
- Load L:** inductive reactive energy (W+ and var+)
- Supp:** energy generated by the load (W-)
- Supp C:** capacitive reactive energy (W- and var-)
- Supp L:** inductive reactive energy (W- and var+)

7. To access the screens concerning the energies received by the load (« Load side »), press the  button to view each screen that has the term “LoAd” at the bottom of the screen.

The sequence of use is as follows:

I- Load h W → Load L h VAR → Load C h VAR → Load h VA → I  
 | <-----|

Example of “LoAd” screen:



8. To access the screens displaying energies generated by the load and therefore received by the source (“Supply side”), press the  button to view the screens that have the term “SuPP” at the bottom of the screen.

The sequence of use is as follows:

I - Supp h W → Supp L h VAR → Supp C h VAR → Supp h VA → I  
 | <-----|

Example of "SuPP" screen:



The energy displays use the following formats:

- [000.1 ; 999.9]
- [1.000 k ; 9999 k]
- [10.0 M ; 999 M]
- [1.00 G ; 999 G]

### 3.12 FREQUENCY MEASUREMENT (HZ)

The frequency measurement is available in **V**, **W** and **A** for AC and AC+DC measurements. The measurement is based on a count of zero crossings (positive-going edges).

#### 3.12.1 Frequency Measurement (V)

To measure the frequency in voltage, proceed as follows:

1. Set the switch to **V<sub>~</sub>** and press the **Hz** button. The **Hz** symbol is displayed.
2. Select AC by pressing the **Hz** (yellow) button until the desired choice is displayed.
3. Connect the black lead to the **COM** terminal and the red lead to the **+** terminal.
4. Connect the test probes or the alligator clips to the circuit to be measured.

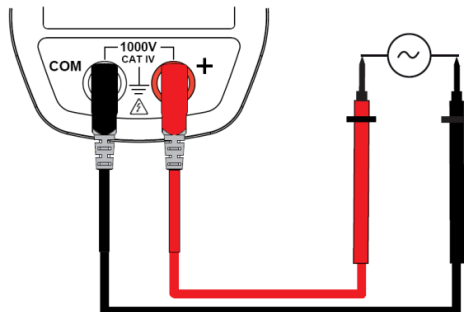

The measured value is displayed on the screen.

### 3.12.2 Frequency Measurement (A)

1. Set the switch to **A** and press the **Hz** button. The **Hz** symbol is displayed.
2. Select AC or AC+DC by pressing the **Yellow** (yellow) button until desired choice is reached.
3. Clamp the jaws around the conductor to be measured.

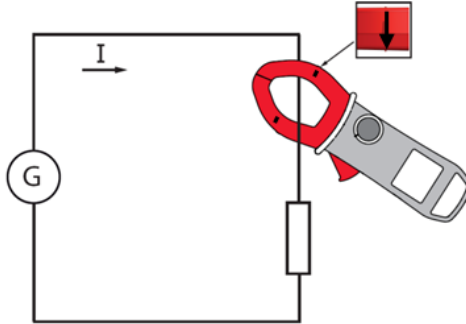

The measured value is displayed on the screen.

### 3.13 TOTAL HARMONIC DISTORTION (THD) AND DISPLAY OF THE HARMONICS ORDER

The instrument measures the total harmonic distortion with respect to the fundamental (THD<sub>f</sub>), the total harmonic distortion with respect to the true RMS value of the signal (THD<sub>r</sub>) in voltage and in current, then the level (with respect to the fundamental), frequency, and RMS value of each order of harmonic.

The frequency of the fundamental is determined by digital filtering and FFT for the network frequencies of 50, 60, 400, and 800Hz.

#### 3.13.1 THD (V)

1. Set the switch to **V** and press and hold (>2s) the **Hz** button. The **THD<sub>f</sub>**, **THD<sub>r</sub>**, and **V RMS** symbols are displayed.
2. Connect the black lead to the **COM** terminal and the red lead to the **+** terminal.
3. Place the test probes or the alligator clips on the terminals of the circuit to be measured.

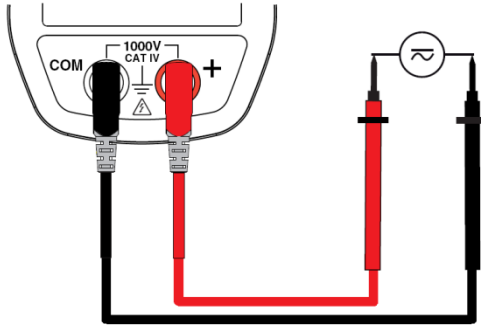

The measurement is displayed on screen.

### 3.13.2 THD (A)

1. Set the switch to **A** and press and hold (>2s) the **Hz** button. The **THD<sub>f</sub>**, **THD<sub>r</sub>**, and **A RMS** symbols are displayed.

**NOTE:** first press the yellow button to place the meter in AC current measurement mode.

2. Apply the clamp to only the conductor concerned.

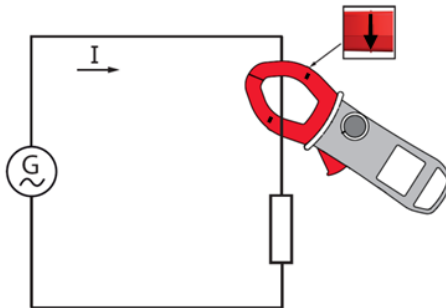

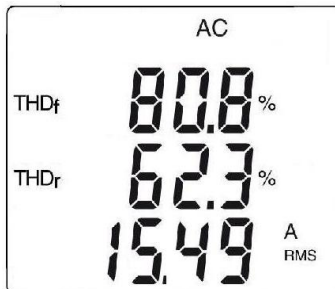

The measurement is displayed on screen.



### 3.13.3 Individual Harmonics and of the Frequency of the Fundamental from DC to the 25<sup>th</sup>

In the context of measurement of the THDs in voltage (§ 3.13.1) and in current (§ 3.13.2):

1. Press the  button. Order "hdC" is displayed (DC component), only in DC or AC+DC. The harmonics of higher orders are displayed sequentially as the  button is pressed repeatedly. The  button can be pressed to return to the previous order.

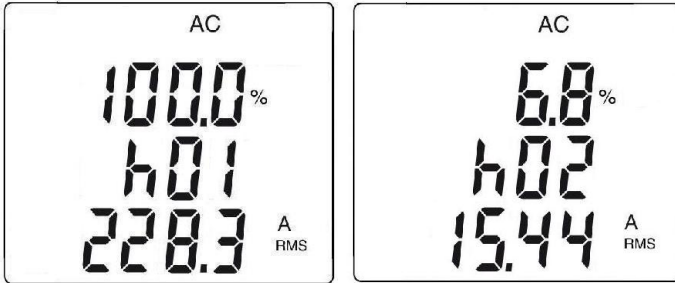

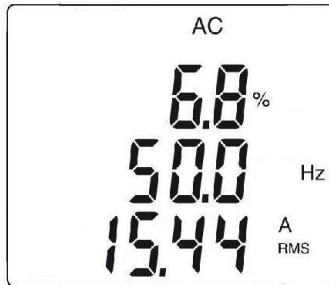

2. The  button can be pressed to display the frequency of the order of harmonic concerned.



### 3.14 RECORDING OF MEASUREMENTS

The power meter allows recording of the data/measurements using the REC function. The default recording interval is 60 seconds. It can be configured (see §3.4.3) from 1 second to 600 seconds (10 minutes).

1. Select the function to be measured using the rotary switch, then apply a long press (> 2s) to the  button. The **REC** symbol is displayed. Recording of the measurement starts. The data recorded is in the format: "MAX value – AVG Value – MIN Value – Unit – Mode" (AC or AC+DC).  
**NOTE:** The meter does not record pure DC measurements
2. To stop recording, apply a long press (>2s) to the  button. The **REC** symbol disappears.

**NOTE:** Recording is interrupted automatically when the memory of the device is full (REC symbol is flashing) or Bluetooth wireless communication is activated (§3.15).

Type of data	Max. number of records	Max. recording time at 1s intervals	Max. recording time at 600s (10 minute) intervals
V, A, $\Omega$	1000	16 minutes	160 hours
W	200	3 minutes	35 hours
THD	300	5 minutes	55 hours
Harmonics	470	8 minutes	80 hours

### 3.15 CONNECTING TO A COMPUTER

#### 3.15.1 Bluetooth Connection

The Model 607 is equipped with Bluetooth connectivity for downloading, displaying, and deleting recorded data in the instrument's memory.

The instrument comes with a Bluetooth USB adapter for use with computers without Bluetooth capability. If this is the case, connect the adapter to an available USB port on your computer. The default Windows driver will automatically install the device.





The instrument must be paired to the computer before connecting to the software. The pairing procedure varies depending on your operating system, Bluetooth equipment and driver software.

**NOTE:** The instructions in the following sections are only necessary the first time an instrument is connected, or when the Bluetooth USB adapter has been removed and then reconnected.



### 3.15.2 Pairing the Instrument to the Computer







The following steps are for pairing using Windows 7:

1. In the active measurement function, press the  and  buttons simultaneously. The  symbol will appear in the upper right corner of the display.
2. Connect the supplied Bluetooth USB Adapter into an available USB port. Windows will install any necessary drivers automatically.
3. A Bluetooth symbol, similar to this , will appear in the system tray at the bottom of your screen once the driver is installed.
4. Right click on the icon and select “Add a Device”.
5. In the “Add a Device” window, select the instrument you wish to connect to and select “**Next**”.

**NOTE:** Depending on the Bluetooth setup and operating system, it may be necessary to enter a passkey to finalize the instrument connection. If so, the default passkey is: **0000**.

6. If asked for a pairing code select the “**Enter the Device’s pairing code**”.
7. Enter the pairing code as shown below and select “**Next**”.
8. Once the instrument has been successfully added to the computer, a window will be displayed. Select “**Close**”.
9. You should see the Device listed in the Bluetooth devices window.
10. Launch the Power Clamp Control Panel by clicking the  icon in the DataView folder placed on the desktop during software installation. Refer to §3.21 for DataView® software installation. The instrument should automatically connect if only one power meter is paired. If more than one instrument is paired, select the instrument you wish to connect to from the drop-down list in the connection window.
11. Selecting OK will establish the connection between the power meter and the software. It is now possible to view the instrument status and downloaded data. If data is present in the instrument’s memory, the software will automatically start downloading once connected.

### 3.16 TURNING BLUETOOTH ON/OFF

Bluetooth can only be turned on or off when the instrument is not recording. To enable Bluetooth press the  and  keys simultaneously. The  symbol should be displayed in the upper right corner of the display. To disable Bluetooth press the  and  keys simultaneously the  symbol will turn off.

## 3.17 RECORDING DATA

### 3.17.1 Starting a Recording Session

**NOTE:** A new recording cannot be started if the memory is full or if Bluetooth is active.

1. Configure the instrument as described in § 3.4.
2. Select the measurement function to be recorded using the rotary switch and connect the instrument to the measurement source.
3. Press the REC button for >2s to start a recording.
4. The REC indication will remain solid when there is available memory or it will blink if the memory is full.
5. If the memory is partially full then it is possible to start another recording. The duration of the recording will depend on the available memory.

### 3.17.2 Stopping a Recording Session

1. Press and hold the REC button for >2s.
2. The REC indication will not be displayed if a recording is not active.



## 3.18 DOWNLOADING RECORDED DATA

Recorded measurements stored in the instrument are transferred to a computer via the download command in the DataView<sup>®</sup> PowerPad Control Panel.

## 3.19 ERASING MEMORY

Erasing data from the instrument's memory can be performed in two ways.

### Erasing Memory using the YELLOW button and rotary switch:

1. Turn the instrument "OFF".
2. Press and hold the  button while rotating the rotary switch to the "Ω" position.
3. Release the  button when **RST REC** is displayed to erase the memory.

### Erasing Memory using the DataView<sup>®</sup> Control Panel:

1. Connect the instrument to the computer and launch the PowerPad Control Panel.
2. Select View Recorded Data from the Instrument menu.
3. In the "Recorded Data in Instrument" window select the "Select All" button and click on "Delete All" to erase the memory.

## 3.20 DATA STORAGE

The Model 607 captures Trend measurements at a user specified interval.

### 3.20.1 Trend Measurements

The Model 607 stores the measurement of each of the inputs. In addition, the user can define the storage rate and type of measurement.

### 3.20.2 Recording with Memory Cleared

When a recording starts, the power meter will continue to record until one of the following occurs:

- The memory becomes full.
- A manual press of the REC button for >2s is performed.
- The battery voltage is not sufficient to keep the instrument powered.

### 3.20.3 Recording with a Partial or Full Memory

It is possible to have more than one recording provided there is sufficient memory. The duration of the additional recording will depend on the sample rate of the recording, amount of memory left and type of recording.

### 3.20.4 Memory Filled During Recording Session

If the memory becomes full, the **REC** indication on the display will blink. It will be necessary to download and erase the memory before a new recording can be started.

## 3.21 DATAVIEW® INSTALLATION

1. Insert the USB drive that comes with the instrument into a USB port on your computer.
2. If Autorun is enabled, an AutoPlay window appears on your screen. Click "Open folder to view files" to display the DataView folder. If Autorun is not enabled or allowed, use Windows Explorer to locate and open the USB drive labeled "DataView."
3. When the DataView folder is open, double-click the file Setup.exe in the root directory.
4. The Setup screen appears. This enables you to select the language version of the setup program. You can also select additional install options (each option is explained in the Description field). Make your selections and click Install.

5. Click OK to confirm setup. The InstallShield Wizard screen appears. This program leads you through the DataView install process. As you complete these screens, be sure to check PowerPad when prompted to select features to install.
6. When the InstallShield Wizard finishes installing DataView, the Setup screen appears. Click Exit to close. The DataView folder appears on your computer desktop.

### 3.22 OPENING THE DATAVIEW CONTROL PANEL

To open the PowerPad Control Panel:

- Double-click the  icon in the DataView folder that was created during installation, located on the desktop.
- The **Connection** window appears.

**NOTE:** If only one power meter is connected to the computer, it will be selected and a connection will be established automatically.

The **Connection** window lists the connected instrument in the Instrument drop-down list.

If multiple units are attached, select the desired unit.

Once the desired instrument has been selected, click **OK** and the **Control Panel** will attempt to connect to the instrument and download any data.

**NOTE:** The default layout can be changed by moving and resizing each window.

### 3.23 USING THE CONTROL PANEL

The PowerPad Control Panel is used to view the instrument status, download, view and erase the memory. It is also used to generate reports in DataView<sup>®</sup> and export the recorded data into an excel format.

For instructions about using PowerPad Control Panel features, consult the Help that comes with the Control Panel.

## 4 SPECIFICATIONS

### 4.1 REFERENCE CONDITIONS

Quantities of Influence	Reference Conditions
Temperature	23°C ±2°C
Relative humidity	45% to 75%
Supply voltage	6.0V ±0.5V
Frequency range of the applied signal	45 to 65Hz
Sine wave	pure
Peak factor of the applied alternating signal	√2
Position of the conductor in the clamp	centered
Adjacent conductors	none
Alternating magnetic field	none
Electric field	none

### 4.2 SPECIFICATIONS UNDER THE REFERENCE CONDITIONS

Accuracy is expressed in ± (x% of the reading (R) + y counts (ct)).

#### 4.2.1 DC Voltage Measurement

Measurement Range	0.00 to 99.99V	100.0 to 999.9V	1000V (1)
Specified Measurement Range	0 to 100% of the measurement range		
Accuracy	0.00 to 9.99V ± (1% R +10cts) 10.00 to 99.99V ± (1% R +3cts)	± (1% R +3cts)	
Resolution	0.01V	0.1V	1V
Input Impedance	10MΩ		

**Note (1)** Above 1000V, a repetitive beep indicates the measured voltage is greater than the instrument's specified safety voltage. The display indicates "OL".

## 4.2.2 AC Voltage Measurement

Measurement Range	0.15 to 99.99V	100.0 to 999.9V	1000V RMS 1400V peak (1)
Specified Measurement Range (2)	0 to 100% of the measurement range		
Accuracy	0.15 to 9.99V ± (1% R +10cts) 10.00 to 99.99V ± (1% R +3cts)	± (1% R +3cts)	
Resolution	0.01V	0.1V	1V
Input Impedance	10MΩ		

**Note (1)** - Above 1000V (RMS), a repetitive beep indicates the measured voltage is greater than the instrument's specified safety voltage. The display indicates "OL".

- Bandwidth in AC = 3 kHz

**Note (2)** Any value between zero and the min. threshold of the measurement range (0.15V) is forced to show "----" on the display.

**Specific Specifications in MAX/MIN mode (from 10Hz to 1kHz, and from 0.30V in AC):**

- Accuracy: add 1% R to the values of the table above.
- Capture of the extreme: approximately 100ms.

## 4.2.3 AC+DC Voltage Measurement

Measurement Range (2)	0.15 to 99.99V	100.0 to 999.9V	1000V RMS (1) 1400V peak
Specified Measurement Range	0 to 100% of the measurement range		
Accuracy	0.15 to 9.99V ± (1% R +10cts) 10 to 99.99V ± (1% R +3cts)	± (1% R +3cts)	
Resolution	0.01V	0.1V	1V
Input Impedance	10MΩ		

**Note (1)** - The display indicates "OL" above 1000V (1400V in PEAK mode). Above 1000V (DC or RMS), a repetitive beep indicates the measured voltage is greater than the instrument's specified safety voltage.

- Bandwidth in AC = 3 kHz

**Note (2)** Any value between zero and the min. threshold of the measurement range (0.15V) is forced to "----" on the display.

**Specific Specifications in MAX/MIN mode in Voltage  
(from 10Hz to 1kHz in AC and AC+DC):**

- Accuracy: add 1% R to the values of the previous table.
- Capture of the extreme: approximately 100ms.

**Specific Specifications in PEAK mode in voltage  
(from 10Hz to 1kHz in AC and AC+DC):**

- Accuracy: add 1.5% R to the values in the previous table.
- PEAK capture time: 1ms min. to 1.5ms max.

**4.2.4 DC Current Measurement**

Measurement Range (2)	0.00 to 99.99A	100.0 to 999.9A	1000 to 3000A (1)
Specified Measurement Range	0 to 100% of the measurement range		
Accuracy (2) (zero corrected)	$\pm (1\% R + 10\text{cts})$	$\pm (1\% R + 3\text{cts})$	2000A $\pm (1.5\% R + 3\text{ pt})$ 2000 to 2500A <sub>DC</sub> $\pm (2.5\% R + 3\text{ pt})$ 2500 to 3000A <sub>DC</sub> $\pm (3.5\% R + 3\text{ pt})$
Resolution	0.01A	0.1A	1A

**Note (1)** The display indicates “+OL” above 3000A.

**Note (2)** The residual current at zero depends on the remanence. It can be corrected by the “DC zero” function of the HOLD button.

**4.2.5 AC Current Measurement**

Measurement Range (2)	0.15 to 99.99A	100.0 to 999.9A	1000 to 2000A (1)
Specified Measurement Range	0 to 100% of the measurement range		
Accuracy	$\pm (1\% R + 10\text{cts})$	$\pm (1\% R + 3\text{cts})$	1000 to 1500A $\pm (1.5\% R + 3\text{cts})$ 1500 to 2000A $\pm (2\% R + 5\text{cts})$
Resolution	0.01A	0.1A	1A

**Note (1)** - The display indicates "OL" above 3000A (in PEAK mode). The "-" and "+" signs are not managed.

- Bandwidth in AC = 1 kHz

**Note (2)** - In AC, any value between zero and the min. threshold of the measurement range (0.15A) is forced to show "----" on the display.

- Residual current at zero <150mA.

#### 4.2.6 AC+DC Intensity Measurement

Measurement Range (2)	0.15 to 99.99A	100.0 to 999.9A	AC: 1000 to 2000A DC or PEAK: 1000 to 3000A (1)
Specified Measurement Range	0 to 100% of the measurement range		
Accuracy (2) (zero corrected)	$\pm (1\% R + 10\text{cts})$	$\pm (1\% R + 3\text{cts})$	2000A $\pm (1.5\% R + 3\text{cts})$ 2000 to 2500A <sub>DC</sub> $\pm (2.5\% R + 3\text{cts})$ 2500 to 3000A <sub>DC</sub> $\pm (3.5\% R + 3\text{cts})$
Resolution	0.01A	0.1A	1A

**Note (1)** - The display indicates "+OL" above 3000A (in PEAK mode). The "-" and "+" signs are not managed.

- Bandwidth in AC = 1 kHz

**Note (2)** - In AC, any value between zero and the min. threshold of the measurement range (0.15A) is forced to show "----" on the display.

- Residual current at zero:

- In DC: depends on the remanence. This can be corrected by the "DC zero" function of the HOLD button

- In AC: <150mA

#### Specific Specifications in MAX/MIN mode (from 10Hz to 1kHz in AC and AC+DC):

- Accuracy: add 1% R to the values of the table above.
- Capture of the extreme: approximately 100ms.

#### Specific characteristics in PEAK mode in current (from 10Hz to 400Hz in AC and AC+DC):

- Accuracy: add 1.5% R to the values in the tables above.
- PEAK capture time: 1ms min. to 1.5ms max.

#### 4.2.7 True InRush® Measurement

Measurement Range	20 to 2000AAC	20 to 3000ADc
Specified Measurement Range	0 to 100% of the measurement range	
Accuracy	$\pm (5\% R + 5\text{cts})$	
Resolution	1A	

#### Specific Specifications in PEAK mode in True InRush® (from 10Hz to 1kHz in AC):

- Accuracy: add  $\pm(1.5\% R + 0.5A)$  to the values in the table above.
- PEAK capture time: 1ms min. to 1.5ms max.



#### 4.2.8 Crest Factor (CF) Calculation

Measurement Range	1.00 to 3.50	3.51 to 5.99	6.00 to 10.00
Specified Measurement Range (from 5V or 5A)	0 to 100% of the measurement range		
Accuracy (zero corrected in ADC)	± (2% R +2cts)	± (5% R +2cts)	± (10% R +2cts)
Resolution	1ct		

**NOTE:** Peak values limited to 1500V or 3000A

#### 4.2.9 RIPPLE in DC Calculation

Measurement Range	0.1 to 99.9%	100.0 to 1000%
Specified Measurement Range (from 3ADC and 2VDC)	2 to 100% of the measurement range	0 to 100% of the measurement range
Accuracy	± (5% R +10cts)	
Resolution	0.1	

**NOTE:** If one of the terms for the calculation of the RIPPLE is displayed as "OL", or forced to zero, the RIPPLE displayed is an indeterminate value, "----".

#### 4.2.10 Continuity Measurement

Measurement Range	0.0 to 999.9Ω
Open-circuit Voltage	≤ 3.6V
Measurement Current	550μA
Accuracy	± (1% R +5cts)
Buzzer Triggering Threshold	40Ω

#### 4.2.11 Resistance Measurement

Measurement Range (1)	0.0 to 999.9Ω	1000 to 9999Ω	10.00 to 99.99kΩ
Specified Measurement Range	1 to 100% of the measurement range	0 to 100% of the measurement range	
Accuracy	± (1% R +5cts)		
Resolution	0.1Ω	1Ω	10Ω
Open-circuit Voltage	≤ 3.6V		
Measurement Current	550μA	100μA	10μA

**Note (1)** Above the maximum display value, the display unit indicates "OL". The "-" and "+" signs are not managed.

#### Specific Specifications in MAX/MIN mode:

- Accuracy: add 1% R to the values of the previous table
- Capture of the extreme: approximately 100ms

#### 4.2.12 Active DC Power Measurements

Measurement Range (2)	0 to 9999W	10.00 to 99.99kW	100.0 to 999.9kW	1000 to 3000kW (1)
Specified Measurement Range	1 to 100% of the measurement range	0 to 100% of the measurement range		
Accuracy (3)	1000A ± (2% R +10cts) 1000 to 2000A ± (2.5% R +10cts) 2000 to 2500A <sub>DC</sub> ± (3.5% R +10cts) 2500 to 3000A <sub>DC</sub> ± (4.5% R +10cts)	1000A ± (2% R +3cts) 1000 to 2000A ± (2.5% R +3cts) 2000 to 2500A <sub>DC</sub> ± (3.5% R +3cts) 2500 to 3000A <sub>DC</sub> ± (4.5% R +3cts)		
Resolution	1W	10W	100W	1000W

**Note (1)** - Display of OL or ± OL.

- Above 3000kW in single-phase (1000V x 3000A).
- Above ±6000kW in REL mode.

**Note (2)** Any applied voltage greater than 1000V causes the emission of an intermittent alarm beep to report a dangerous overload.

**Note (3)** The measurement result may be affected by an instability linked to the current measurement (approximately 0.1A).

**Example:** For a power measurement made at 10A, the instability of the measurement will be 0.1A/10A or 1%.

#### 4.2.13 Active AC Power Measurements

Measurement Range (2) (4)	5 to 9999W	10.00 to 99.99kW	100.0 to 999.9kW	1000 to 2000kW (1)
Specified Measurement Range	1 to 100% of the measurement range	0 to 100% of the measurement range		
Accuracy (3)	1000A ± (2% R +10cts)	1000A ± (2% R +3cts)		
Resolution	1W	10W	100W	1000W

**Note (1)** - Display of OL above 2000kW in single-phase (1000V x 2000A).  
- Bandwidth in AC in voltage = 3 kHz, in current = 1 kHz

**Notes (2) and (3)** of the previous § apply.

**Note (4)** Any power measured less than 5W is regarded as zero and causes the display of dashes "----"

If the voltage is less than 0.15V or if the current is less than 0.15A, the power measured is regarded as zero and causes the display of "----"

**Note 5** The active powers are positive for power consumed and negative for power generated.

**Note 6** The signs of the active and reactive powers and power factor are defined by the four-quadrant rule:  
The diagram below sums up the signs of the power as a function of the phase angle between  $V$  and  $I$ :

Quadrant 1: Active power $P$	sign + (power consumed)
Quadrant 2: Active power $P$	sign - (power generated)
Quadrant 3: Active power $P$	sign - (power generated)
Quadrant 4: Active power $P$	sign + (power consumed)

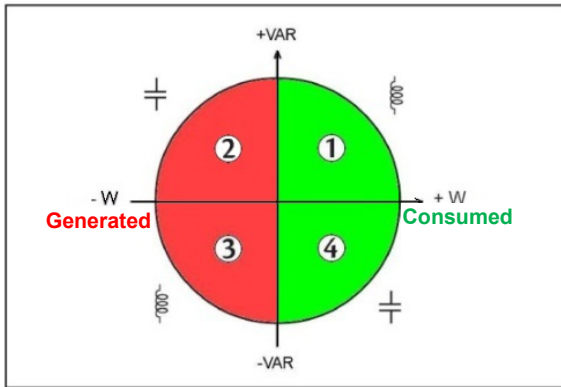

**Note (7)** In balanced three-phases, with deformed signals (THD and harmonics), uncertainties are guaranteed since  $\Phi > 30^\circ$ . Additional errors are following, depending of THD:

- Add +1% for  $10\% < THD < 20\%$
- Add +3% for  $20\% < THD < 30\%$
- Add +5% for  $30\% < THD < 40\%$

#### 4.2.14 Active AC+DC Power Measurement

Measurement Range (2) (4)	5 to 9999W	10.00 to 99.99kW	100.0 to 999.9kW	1000 to 3000kW (1)
Specified Measurement Range	1 to 100% of the measurement range	0 to 100% of the measurement range		
Accuracy (3)	1000A ± (2% R +10cts) 1000 to 2000A ± (2.5% R +10cts) 2000 to 2500A <sub>DC</sub> ± (3.5% R +10cts) 2500 to 3000A <sub>DC</sub> ± (4.5% R +10cts)	1000A ± (2% R +3cts) 1000 to 2000A ± (2.5% R +3cts) 2000 to 2500A <sub>DC</sub> ± (3.5% R +3cts) 2500 to 3000A <sub>DC</sub> ± (4.5% R +3cts)		
Resolution	1W	10W	100W	1000W

**Note (1)** - Display of OL

- Above 3000kW in single-phase (1000V x 3000A)

**Notes (2), (3), (4), (5) (6) and (7)** of the previous § apply

#### 4.2.15 Apparent AC Power Measurement

Measurement Range (2) (4)	5VA to 9999VA	10.00kVA to 99.99kVA	100.0kVA to 999.9kVA	1000 kVA to 2000 kVA (1)
Specified Measurement Range	1 to 100% of the measurement range	0 to 100% of the measurement range		
Accuracy (3)	1000A ± (2% R +10cts) 1000 to 2000A ± (2.5% R +10cts)	1000A ± (2% R +3cts) 1000 to 2000A ± (2.5% R +3cts)		
Resolution	1VA	10VA	100VA	1000VA

**Note (1)** - Display of O.L above 2000 kVA in single-phase (1000V x 2000A).

- Bandwidth in AC in voltage = 3 kHz, in current = 1 kHz

**Notes (2), (3) and (4)** of the previous § apply

#### 4.2.16 Apparent AC+DC Power Measurement

Measurement Range (2) (4)	5 to 9999VA	10.00 to 99.99kVA	100.0 to 999.9kVA	1000 to 3000kVA (1)
Specified Measurement Range	1 to 100% of the measurement range	0 to 100% of the measurement range		
Accuracy (3)	1000A ± (2% R +10cts) 1000 to 2000A ± (2.5% R +10cts) 2000 to 2500A <sub>DC</sub> ± (3.5% R +10cts) 2500 to 3000A <sub>DC</sub> ± (4.5% R +10cts)	1000A ± (2% R +3cts) 1000 to 2000A ± (2.5% R +3cts) 2000 to 2500A <sub>DC</sub> ± (3.5% R + 3cts) 2500 to 3000A <sub>DC</sub> ± (4.5% R + 3cts)		
Resolution	1VA	10VA	100VA	1000VA

**Note (1)** - Display of OL above 3000 kVA in single-phase (1000V x 3000A).  
- Bandwidth in AC in voltage = 3 kHz, in current = 1 kHz

**Notes (2), (3) and (4)** of the previous § apply

#### 4.2.17 Reactive AC Power Measurement

Measurement Range (2) (4)	5 to 9999 var	10.00 to 99.99 kvar	100.0 to 999.9 kvar	1000 to 2000 kvar (1)
Specified Measurement Range	1 to 100% of the measurement range	0 to 100% of the measurement range		
Accuracy (3) (7)	1000A ± (2% R +10cts) 1000 to 2000A ± (2.5% R +10cts)	1000A ± (2% R +3cts) 1000 to 2000A ± (2.5% R +3cts)		
Resolution	1 var	10 var	100 var	1 kvar

**Note (1)** - Display of OL above 2000 kvar in single-phase (1000V x 2000A).  
- Bandwidth in AC in voltage = 3 kHz, in current = 1 kHz

**Notes (2), (3) and (4)** of the previous § apply

**Note 5** In single-phase, the sign of the reactive power is determined by the phase lead or lag between the V and I signs, while in balanced three-phase, it is determined by the calculation on the samples.

**Note 6** - Signs of reactive powers according to the four-quadrant rule (§4.2.12):  
 Quadrant 1: Reactive power Q sign +  
 Quadrant 2: Reactive power Q sign +  
 Quadrant 3: Reactive power Q sign -  
 Quadrant 4: Reactive power Q sign -

**Note (7)** Measurement stabilization ~8 sec

#### 4.2.18 Reactive AC+DC Power Measurement

Measurement Range (2) (4)	5 to 9999 var	10.00 to 99.99 kvar	100.0 to 999.9 kvar	1000 to 3000 kvar (1)
Specified Measurement Range	1 to 100% of the measurement range	0 to 100% of the measurement range		
Accuracy (3) (7)	1000A ± (2% R +10cts) 1000 to 2000A ± (2.5% R +10cts) 2000 to 2500A <sub>DC</sub> ± (3.5% R+10cts) 2500 to 3000A <sub>DC</sub> ± (4.5% R+10cts)	1000A ± (2% R +3cts) 1000 to 2000A ± (2.5% R +3cts) 2000 to 2500A <sub>DC</sub> ± (3.5% R+3cts) 2500 to 3000A <sub>DC</sub> ± (4.5% R+3cts)		
Resolution	1 var	10 var	100 var	1 kvar

**Note (1)** - Display of OL above 3000 kvar in single-phase (1000V x 3000A).  
- Bandwidth in AC in voltage = 3 kHz, in current = 1 kHz

**Notes (2), (3), (4), (5), (6) and (7)** of the previous § apply

#### Specific characteristics in MAX/MIN mode in power (from 10Hz to 1kHz in AC and AC+DC):

- Accuracy: add 1% R to the values in the table above.
- Capture time: approximately 100ms

#### 4.2.19 Power Factor (PF) Calculation

Measurement Range (1)	0.00 to +1.00	
Specified Measurement Range	0 to 50% of the measurement range	50 to 100% of the measurement range
Accuracy (2)	± (3% R +3cts)	± (2% R +3cts)
Resolution	0.01	

**Note (1)** If one of the terms in the calculation of the power factor is displayed as "OL", or forced to zero, the display of the power factor is an indeterminate value "----".

**Note (2)** In balanced three-phases, with deformed signals (THD and harmonics), uncertainties are guaranteed since  $\Phi > 30^\circ$ . Additional errors are following, depending of THD:

- Add +1% for 10% < THD < 20%
- Add +3% for 20% < THD < 30%
- Add +5% for 30% < THD < 40%

**NOTE:** The PF is always positive

#### Specific characteristics in MAX/MIN mode (from 10Hz to 1kHz):

- Accuracy: add 1% R to the values in the table above.
- Capture time: approximately 100ms.

## 4.2.20 Displacement Power Factor (DPF) Calculation

Measurement Range (1)	0.00 to +1.00
Specified Measurement Range (from 1AAC)	0 to 100% of the measurement range
Accuracy (2) (3)	$\pm (5\% R + 2\text{cts})$
Resolution	0.01

**Note (1)** If one of the terms in the calculation of the DPF is displayed as "OL", or forced to zero, the display of the DPF is an indeterminate value "----".

**Note (2)** of the previous § apply

**Note (3)** Measurement stabilization ~8 sec

**NOTE:** The DPF is always positive. It is equivalent to  $|\cos \Phi|$

### Specific characteristics in MAX/MIN mode (from 10Hz to 1kHz):

- Uncertainties: add 1% R to the values in the table above.
- Capture time: approximately 100ms.

## 4.2.21 Frequency Measurements

### 4.2.21.1 Voltage

Measurement Range (1)	5.0 to 999.9Hz	1000 to 9999Hz	10.00 to 19.99kHz
Specified Measurement Range	1 to 100% of the measurement range	0 to 100% of the measurement range	
Accuracy	$\pm (0.4\% R + 1\text{ct})$		
Resolution	0.1Hz	1Hz	10Hz

### 4.2.21.2 Current

Measurement Range (1)	5.0 to 1999Hz
Specified Measurement Range	1 to 100% of the measurement range
Accuracy	$\pm (0.4\% R + 1\text{ct})$
Resolution	0.1Hz

**Note (1)** In MAX/MIN mode, the operating range is limited to 1kHz. If the level of the signal is too low (<10% of the range, or  $V < 8V$  or  $I < 9A$ ) or if the frequency is less than 5Hz, the device cannot determine the frequency and displays "----".

### Specific Specifications in MAX/MIN mode (from 10Hz to 1kHz):

- Accuracy: add 1% R to the values of the table above.
- Capture of the extreme: approximately 100ms.

#### 4.2.22 THDr Specifications

Measurement Range	0.0 to 100%
Specified Measurement Range	0 to 100% of the measurement range
Accuracy	$\pm$ (5% R $\pm$ 2cts) in voltage $\pm$ (5% R $\pm$ 5cts) in current
Resolution	1%

#### 4.2.23 THDf Specifications

Measurement Range	0.0 to 1000%
Specified Measurement Range	0 to 100% of the measurement range
Accuracy	$\pm$ (5% R $\pm$ 2cts) in voltage $\pm$ (5% R $\pm$ 5cts) in current
Resolution	1%

**Note** : The display is "----" if the input signal is too low ( $V < 8V$  or  $I < 9A$ ) or if the frequency is less than 5Hz.

#### Specific characteristics in MAX/MIN mode in THD (from 10Hz to 1kHz):

- Accuracy: add 1% R to the values in the table above.
- Capture of the extreme: approximately 100ms

#### 4.2.24 Harmonic Measurement Specifications

Measurement Range in Voltage	Per §4.2.2 and §4.2.3
Measurement Range in Current	Per §4.2.5 and §4.2.6
Harmonic Range	AC: harmonics of orders 1 to 25 AC+DC: all orders from 1 to 25, plus the DC component
Frequency Analysis Band	- 0 to 25 times the fundamental frequency, from among the network frequencies 50, 60, and 400Hz - 0 to 12 times the fundamental frequency of an 800Hz network
Stability of the Current and Voltage Display	$\pm$ (1% R $\pm$ 2cts)
Accuracy on the RMS value of the harmonic (zero corrected in Abc)	Level >10% and order <13: $\pm$ (5% R $\pm$ 2cts) Level >10% and order >13: $\pm$ (10% R $\pm$ 2cts) Level <10% and order <13: $\pm$ (10% R $\pm$ 2cts) Level <10% and order >13: $\pm$ (15% R $\pm$ 2cts)

**Note**: The display is "----" if the input signal is too low ( $U < 8V$  or  $I < 9A$ ) or if the frequency is less than 5Hz.



### Specific characteristics in MAX/MIN mode in THD (from 10Hz to 1kHz):

- Accuracy: add 1% R to the values in the tables above.
- Capture time of the extreme: approximately 100ms

### 4.3 ENVIRONMENTAL CONDITIONS

Conditions	Operating	Storage
Temperature	-4° to +131°F (-20° to +55°C)	-40° to +158°F (-40° to +70°C)
Relative humidity (RH)	≤90% up to 131°F (55°C)	≤90% up to 158°F (70°C)

### 4.4 MECHANICAL SPECIFICATIONS

Housing	Rigid polycarbonate shell with over-molded elastomer covering; UL94 V1
Jaws	Polycarbonate Opening: 2.36" (60mm) Clamping diameter: 2.36" (60mm)
Screen	LCD display unit Blue backlighting Dimension: 1.6 x 1.9" (41 x 48mm)
Dimension	11.65 x 4.37 x 1.61" (296 x 111 x 41mm)
Weight	1.4 lbs (640g) with batteries



### 4.5 POWER SUPPLY

Batteries	4x1.5V AA LR6
Battery Life	>350 hours (without backlighting and Bluetooth)
Auto Power Off	After 10 minutes with no switch and/or button activity

### 4.6 COMPLIANCE WITH INTERNATIONAL STANDARDS

Electric safety	Compliant with standards IEC-61010-1, IEC-61010-2-30, and IEC-61010-2-32: 1000V CAT IV.
Electromagnetic compatibility	Compliant with standard EN-61326-1 Classification: residential environment
Mechanical strength	Free fall: 2m (in accordance with standard IEC-68-2-32)
Level of protection of the housing	Housing: IP54 (per standard IEC-60529) Jaws: IP40

## 4.7 ENVIRONMENTAL VARIATIONS

Condition of influence	Range of influence	Measurement influenced	Influence	
			Typical	MAX
Temperature	-4° to +131°F (-20 to +55°C)	V AC V DC A* $\Omega$  W AC W DC	- 0.1% R/10°C 1% R/10°C*	0.1% R/10°C 0.5% R/10°C + 2cts 1.5% R/10°C + 2cts* 0.1% R/10°C + 2 cts 0.2% R/10°C + 2 cts 0.3% R/10°C + 2 cts
Humidity	10% to 90%RH	V A $\Omega$  W	≤ 1 ct - 0.2% R 0.25% R	0.1R + 1 ct 0.1% R + 2 cts 0.3% R + 2 cts 0.5% R + 2 cts
Frequency	10 Hz to 1 kHz 1 kHz to 3 kHz 10 Hz to 400 Hz 400 Hz to 1 kHz	V A	1% R + 1 ct 8% R + 1 ct 1% R + 1 ct 4% R + 1 ct	1% R + 1 ct 9% R + 1 ct 1% R + 1 ct 5% R + 1 ct
Position of the conductor in the jaws (f≤400 Hz)	Any position on the internal perimeter of the jaws	A-W (<2000A DC or 1400A AC) (>2000A DC)	2% R 8% R	4% R + 1 ct Full-scale
Adjacent conductor carrying a current of 150 A DC or RMS	Conductor touching the external perimeter of the jaws	A-W	40 dB	30 dB
Conductor enclosed by the clamp	0 to 500 A DC or RMS	V	< 1 ct	1 ct
Application of a voltage of the clamp	0 to 1000 V DC or RMS	A-W	< 1 ct	1 ct
Peak factor (1)	1.4 to 3.5 limited to 3000 A peak 1400 V peak	A (AC-AC+DC) V (AC-AC+DC)	1% R 1% R	3% R + 1 ct 3% R + 1 ct
PF (inductive and capacitive)	0.7 and I ≥ 5A 0.5 and I ≥ 10A 0.2 and I ≥ 20A	W	0.5%R	1% R + 1 ct 3% R + 1 ct 8% R + 1 ct

\*Note in Temperature: Influence specified until 1000A<sub>DC</sub>

## 5 MAINTENANCE

---

### 5.1 WARNING:

- Remove the test leads on any input before opening the case.
- Do not operate the clamp-on meter without a battery case cover.
- To avoid electrical shock, do not attempt to perform any servicing unless you are qualified to do so.
- To avoid electrical shock and/or damage to the instrument, do not get water or other foreign agents into the probe.

### 5.2 CLEANING

- Disconnect everything connected to the device and set the switch to OFF.
- Use a soft cloth moistened with soapy water. Rinse with a damp cloth and dry quickly using a dry cloth or forced air.
- Dry completely before putting back into use.

### 5.3 BATTERY REPLACEMENT

The  symbol indicates that the batteries are low. When this symbol appears on the display unit, the batteries must be replaced. The measurements and specifications are no longer guaranteed.

To replace the batteries, proceed as follows:

1. Disconnect the measurement leads from the input terminals.
2. Set the switch to OFF.
3. Using a screwdriver, unscrew the battery compartment cover from the back of the housing (see §3.1).
4. Remove the used batteries and replace them with 4x1.5V AA batteries, observing the polarities.
5. Close the battery compartment cover and screw it onto the housing.

## 6 REPAIR AND CALIBRATION

---

To ensure that your instrument meets factory specifications, we recommend that it be submitted to our factory Service Center at one-year intervals for recalibration, or as required by other standards or internal procedures.

### **For instrument repair and calibration:**

You must contact our Service Center for a Customer Service Authorization number (CSA#). This will ensure that when your instrument arrives, it will be tracked and processed promptly. Please write the CSA# on the outside of the shipping container. If the instrument is returned for calibration, we need to know if you want a standard calibration, or a calibration traceable to N.I.S.T. (includes calibration certificate plus recorded calibration data).

Chauvin Arnoux<sup>®</sup>, Inc. d.b.a. AEMC<sup>®</sup> Instruments  
15 Faraday Drive  
Dover, NH 03820 USA

Tel: (800) 945-2362 (Ext. 360)  
(603) 749-6434 (Ext. 360)  
Fax: (603) 742-2346 or (603) 749-6309

[repair@aemc.com](mailto:repair@aemc.com)

(Or contact your authorized distributor)

Costs for repair, standard calibration, and calibration traceable to N.I.S.T. are available.

**NOTE: All customers must obtain a CSA# before returning any instrument.**

## 7 TECHNICAL AND SALES ASSISTANCE

---

If you are experiencing any technical problems, or require any assistance with the proper operation or application of your instrument, please call, mail, fax or e-mail our technical support hotline:

Chauvin Arnoux<sup>®</sup>, Inc. d.b.a. AEMC<sup>®</sup> Instruments  
200 Foxborough Boulevard  
Foxborough, MA 02035, USA

Phone: (800) 343-1391  
(508) 698-2115  
Fax: (508) 698-2118

[techsupport@aemc.com](mailto:techsupport@aemc.com)  
[www.aemc.com](http://www.aemc.com)

**NOTE: Do not ship instruments to our Foxborough, MA address.**

## 8 LIMITED WARRANTY

The Model 607 is warranted to the owner for a period of three years from the date of original purchase against defects in manufacture. This limited warranty is given by AEMC® Instruments, not by the distributor from whom it was purchased. This warranty is void if the unit has been tampered with, abused or if the defect is related to service not performed by AEMC® Instruments.

**Full warranty coverage and product registration is available on our website at [www.aemc.com/warranty.html](http://www.aemc.com/warranty.html).**

**Please print the online Warranty Coverage Information for your records.**

If a malfunction occurs within the three-year period, you may return the instrument to us for repair, provided we have your warranty registration information on file or a proof of purchase. AEMC® Instruments will, at its option, repair or replace the faulty material.

**REGISTER ONLINE AT: [www.aemc.com](http://www.aemc.com)**

## 9 WARRANTY REPAIRS

**What you must do to return an Instrument for Warranty Repair:**

First, request a Customer Service Authorization Number (CSA#) by phone or by fax from our Service Department (see address below), then return the instrument along with the signed CSA Form. Please write the CSA# on the outside of the shipping container. Return the instrument, postage or shipment pre-paid to:

Chauvin Arnoux®, Inc. d.b.a. AEMC® Instruments  
15 Faraday Drive • Dover, NH 03820 USA  
Tel: (800) 945-2362 (Ext. 360)  
(603) 749-6434 (Ext. 360)  
Fax: (603) 742-2346 or (603) 749-6309  
[repair@aemc.com](mailto:repair@aemc.com)

**Caution:** To protect yourself against in-transit loss, we recommend you insure your returned material.

**NOTE:** All customers must obtain a CSA# before returning any instrument.







Chauvin Arnoux<sup>®</sup>, Inc. d.b.a AEMC<sup>®</sup> Instruments  
15 Faraday Drive • Dover, NH 03820 USA  
[www.aemc.com](http://www.aemc.com)

99-MAN 100371 v12 03/20

0.561.8187

[www.itm.com](http://www.itm.com)

[information@itm.com](mailto:information@itm.com)