

User Manual  
ENGLISH



# Power & Energy Logger Model PEL 52



**POWER & ENERGY LOGGER**

*Measure Up*  
WITH AEMC INSTRUMENTS



## Statement of Compliance

Chauvin Arnoux®, Inc. d.b.a. AEMC® Instruments certifies that this instrument has been calibrated using standards and instruments traceable to international standards.

We guarantee that at the time of shipping your instrument has met the instrument's published specifications.

**An NIST traceable certificate may be requested at the time of purchase, or obtained by returning the instrument to our repair and calibration facility, for a nominal charge.**

The recommended calibration interval for this instrument is 12 months and begins on the date of receipt by the customer. For recalibration, please use our calibration services. Refer to our repair and calibration section .

**Serial #:** \_\_\_\_\_

**Catalog #:** 2137.69 / 2137.71

**Model #:** PEL 52

Please fill in the appropriate date as indicated:

Date Received: \_\_\_\_\_

Date Calibration Due: \_\_\_\_\_





Chauvin Arnoux®, Inc.  
d.b.a AEMC® Instruments

---

## TABLE OF CONTENTS

---

<b>1. INTRODUCTION</b> .....	<b>7</b>
1.1 PRECAUTIONS FOR USE .....	8
1.2 RECEIVING YOUR SHIPMENT .....	8
1.3 ORDERING INFORMATION.....	11
1.3.1 Accessories.....	11
1.3.2 Replacement Parts .....	11
1.4 CHARGING THE BATTERY .....	12
<b>2. PRODUCT FEATURES</b> .....	<b>13</b>
2.1 DESCRIPTION.....	13
2.2 INSTRUMENT FRONT PANEL .....	14
2.3 INSTRUMENT TERMINAL BLOCK .....	14
2.4 INSTRUMENT REAR PANEL .....	15
2.5 SD CARD SLOT.....	15
2.6 MOUNTING .....	16
2.7 BUTTON FUNCTIONS.....	16
2.8 LCD DISPLAY .....	17
2.9 MEMORY CARD.....	19
<b>3. SETUP</b> .....	<b>20</b>
3.1 TURNING THE INSTRUMENT ON AND OFF .....	20
3.1.1 Turning On.....	20
3.1.2 Auto Off .....	20
3.1.3 Turning Off .....	20
3.1.4 Battery Operation.....	21
3.2 CONFIGURING THE INSTRUMENT.....	21
3.2.1 Network Type .....	21
3.2.2 Wi-Fi.....	22
3.2.3 Nominal Primary Current.....	26
3.2.4 Aggregation Period.....	27
3.2.5 Reset .....	27
3.3 REMOTE USER INTERFACE .....	28
3.4 INFORMATION .....	30
<b>4. OPERATION</b> .....	<b>32</b>
4.1 DISTRIBUTION NETWORKS & CONNECTIONS OF THE PEL .....	32
4.1.1 Single-Phase 2-wire: 1P-2W1I .....	32
4.1.2 Single-Phase 3-wire 2-currents: 1P-3W2I .....	33
4.1.3 Two-Phase 3-wire (two-phase from a mid-tap transformer): 2P-3W2I.....	33

4.2 RECORDING .....	34
4.3 MEASURED VALUE DISPLAY MODES.....	34
4.3.1 Measurement Mode  .....	35
4.3.2 Energy Mode  .....	37
4.3.3 Maximum Mode  .....	38
<b>5. PEL CONTROL PANEL - DATAVIEW® .....</b>	<b>41</b>
5.1 INSTALLING DATAVIEW® .....	41
5.2 PEL CONTROL PANEL .....	45
<b>6. SPECIFICATIONS .....</b>	<b>46</b>
6.1 REFERENCE CONDITIONS .....	46
6.2 ELECTRICAL PROPERTIES.....	46
6.2.1 Voltage Inputs .....	46
6.2.2 Current Inputs.....	47
6.2.3 Intrinsic Uncertainty (Excluding Current Sensors) .....	47
6.2.3.1 Specifications of the PEL .....	47
6.2.4 Current Sensors .....	49
6.2.4.1 Precautions For Use.....	49
6.2.4.2 Characteristics .....	50
6.2.4.3 Intrinsic Uncertainty .....	54
6.3 VARIATION IN THE FIELD OF USE .....	56
6.3.1 General .....	56
6.3.2 Temperature .....	56
6.3.3 Humidity.....	56
6.3.4 Continous Component.....	56
6.3.5 Frequency.....	56
6.3.6 Bandwidth.....	57
6.3.7 Disturbed Signals .....	57
6.4 POWER SUPPLY.....	57
6.5 ENVIRONMENTAL CHARACTERISTICS.....	58
6.6 Wi-Fi.....	58
6.7 MECHANICAL CHARACTERISTICS .....	58
6.8 ELECTRICAL SAFETY .....	59
6.9 ELECTROMAGNETIC COMPATIBILITY.....	59
6.10 RADIO EMISSION.....	59
6.11 MEMORY CARD .....	59











<b>7. MAINTENANCE</b> .....	<b>60</b>
7.1 CLEANING.....	60
7.2 BATTERY.....	60
7.3 UPDATING FIRMWARE.....	61
7.4 REPAIR AND CALIBRATION .....	61
7.5 TECHNICAL AND SALES ASSISTANCE.....	62
7.6 LIMITED WARRANTY.....	62
7.6.1 Warranty Repairs .....	63
<b>8. APPENDIX</b> .....	<b>64</b>
8.1 MEASUREMENTS.....	64
8.1.1 Definition .....	64
8.1.2 Sampling .....	64
8.1.2.1 "1 s" (one second) Quantities .....	64
8.1.2.2 Aggregation.....	65
8.1.2.3 Minimum and Maximum .....	65
8.1.2.4 Calculation of Energies .....	65
8.2 MEASUREMENT FORMULAS.....	65
8.3 AGGREGATION.....	66
8.4 SUPPORTED ELECTRICAL NETWORKS .....	67
8.5 VALUES AVAILABLE .....	68
8.6 GLOSSARY.....	70

# 1. INTRODUCTION

Thank you for purchasing an AEMC® Instruments **Power & Energy Logger Model PEL 52**.

For the best results from your instrument and for your safety, you must read the enclosed operating instructions carefully and comply with the precautions for use. Only qualified and trained operators should use this product.

## Symbols & Definitions

	Signifies that the instrument is protected by double or reinforced insulation
	<b>CAUTION - Risk of Danger!</b> Indicates a <b>WARNING</b> . Whenever this symbol is present, the operator must refer to the user manual before operation
	Indicates a risk of electric shock. The voltage at the parts marked with this symbol may be dangerous
	Indicates Important information to acknowledge
	Magnet
	SD Card
	This product complies with the Low Voltage & Electromagnetic Compatibility European directives (73/23/CEE & 89/336/CEE)
	The UKCA marking certifies that the product is compliant with the requirements that apply in the United Kingdom, specifically regarding Low-Voltage Safety, Electromagnetic Compatibility, and the Restriction of Hazardous Substances.
	The product has been declared recyclable
	In the European Union, this product is subject to a separate collection system for recycling electrical and electronic components in accordance with directive WEEE 2002/96/EC
	Chauvin Arnoux® and AEMC® Instruments have adopted an Eco-Design approach in order to design this instrument. Analysis of the complete lifecycle has enabled us to control and optimize the effects of the product on the environment. In particular this instrument exceeds regulation requirements with respect to recycling and reuse

## Definition of Measurement Categories (CAT)

**CAT IV** corresponds to measurements performed at the primary electrical supply (< 1000 V).

*Example: primary overcurrent protection devices, ripple control units, and meters.*

**CAT III** corresponds to measurements performed in the building installation at the distribution level.

*Example: hardwired equipment in fixed installation and circuit breakers.*

**CAT II** corresponds to measurements performed on circuits directly connected to the electrical distribution system.

*Example: measurements on household appliances and portable tools.*

## 1.1 PRECAUTIONS FOR USE

This device complies with safety standard IEC/EN 61010-2-30 or BS EN 61010-2-030. The leads comply with IEC/EN 61010-031 or BS EN 61010-031. The current sensors comply with IEC/EN 61010-2-032 or BS EN 61010-2-032 for voltages up to 600 V in CAT III.

Failure to observe the safety instructions may result in electric shock, fire, explosion, destruction of the device, or destruction of the installations.

- The operator and responsible authority must read and understand all precautions needed before using the instrument. This instrument requires the user to have knowledge and awareness of electrical hazards.
- Use only the supplied leads and accessories. If you use leads or accessories with a lower voltage or category rating than the instrument, the combined instrument, leads, and accessories are limited to the lower voltage or category rating of the leads or accessories.
- Before each use, check the condition of the insulation on the leads, housing, and accessories. Any items with a degree of deteriorated insulation must be set aside to repair or discard.
- Do not use the instrument on networks where the voltage or category exceeds the instrument's specifications.
- Do not use the instrument if it seems to be damaged, incomplete, or poorly closed.
- When removing and inserting the SD card, the device must be disconnected and turned off.
- Use personal protection equipment when applicable.
- When handling the leads and alligator clips, keep your fingers behind the physical guard.
- If the device is wet, dry it before use.
- All troubleshooting and calibration checks must be performed by competent, accredited personnel.

## 1.2 RECEIVING YOUR SHIPMENT

Upon receiving your shipment, make sure that the contents are consistent with the packing list. Notify your distributor of any missing items. If the equipment appears to be damaged, file a claim immediately with the carrier, and notify your distributor at once with a detailed description of any damage. Save the damaged packing container to substantiate your claim.

## PRODUCT PACKAGING (2137.69)



Power & Energy Logger  
PEL 52  
Cat. #2137.69



Soft Carrying Bag  
Cat. #2126.71



(2) MiniFlex® MA193-10-BK  
Cat. #2140.48



Adapter for Power Cord  
Cat. #5100.14



(1) USB SD Card Adapter  
Cat. #5000.45



(12) Color-coded  
ID Markers  
Cat. #2140.45



(1) 4 GB USB Drive  
with User Manual &  
Dataview® Software



(1) Power Cord,  
5 ft 115 V  
Cat. #5000.14



(3) Black Leads &  
Alligator Clips  
Cat. #2140.44

**Also Included:**

- (1) Safety Sheet for the PEL
- (1) Safety Sheet for the MiniFlex® Sensors
- (1) Compliance Sheet
- (1) SD Card
- (1) Quick Start Guide
- (2) AAA Rechargeable Batteries
- (1) Battery Information Sheet



## PRODUCT PACKAGING (2137.71)



Power & Energy Logger  
PEL 52  
Cat. #2137.71



Soft Carrying Bag  
Cat. #2126.71



(12) Color-coded  
ID Markers  
Cat. #2140.45



Adapter for Power Cord  
Cat. #5100.14



(1) USB SD Card Adapter  
Cat. #5000.45



(3) Black Leads &  
Alligator Clips  
Cat. #2140.44



(1) 4 GB USB Drive  
with User Manual &  
Dataview® Software



(1) Power Cord,  
5 ft 115 V  
Cat. #5000.14

### Also Included:

- (1) Safety Sheet for the PEL
- (1) Compliance Sheet
- (1) SD Card
- (1) Quick Start Guide
- (2) AAA Rechargeable Batteries
- (1) Battery Information Sheet

### 1.3 ORDERING INFORMATION

**Power & Energy Logger Model PEL 52..... Cat. #2137.69**

*Includes Soft carrying bag, (2) MiniFlex® MA193-10-BK sensors, (3) black test leads and alligator clips, 115 V US power cord, adapter for power cord, SD card, USB SD card adapter, (2) AAA rechargeable batteries (installed), quick start guide, and USB drive with DataView® software and User Manual.*

**Power & Energy Logger Model PEL 52 (No Probes) ..... Cat. #2137.71**

*Includes Soft carrying bag, (3) black test leads and alligator clips, 115 V US power cord, adapter for power cord, SD card, USB SD card adapter, (2) AAA rechargeable batteries (installed), quick start guide, and USB drive with DataView® software and User Manual.*

#### 1.3.1 Accessories

AC Current Probe Model MN93-BK..... **Cat. #2140.32**

AC Current Probe Model SR193-BK..... **Cat. #2140.33**

AC Current Probe Model MN193-BK..... **Cat. #2140.36**

AmpFlex® Sensor 24 in Model 193-24-BK..... **Cat. #2140.34**

AmpFlex® Sensor 36 in Model 193-36-BK..... **Cat. #2140.35**

MiniFlex® Sensor 10 in Model MA193-10-BK..... **Cat. #2140.48**

MiniFlex® Sensor 14 in Model MA193-14-BK ..... **Cat. #2140.50**

MiniFlex® Sensor 24 in Model MA194-24-BK ..... **Cat. #2140.80**

AC Current Probe Model MN94 ..... **Cat. #2140.81**

Set of 2, color-coded (red/black) magnetized voltage probes (Rated 600 V CAT IV, 1000 V CAT III)..... **Cat. #5000.43**

#### 1.3.2 Replacement Parts

Lead – (1) 10 ft (3 m) Black Lead with (1) Black Alligator Clip  
Lead rated 1000 V CAT IV 15 A, Clip rated 1000 V  
CAT IV 15 A, UL for PowerPad & PEL Series ..... **Cat. #2140.44**

Set of 12, color input ID markers for the PowerPad Series ..... **Cat. #2140.45**

USB SD - card adapter for PEL 102, PEL 103 & PEL 52..... **Cat. #5000.45**

## 1.4 CHARGING THE BATTERY

Before using the device for the first time, fully charge the battery at a temperature between (50 to 104) °F (10 to 40) °C.

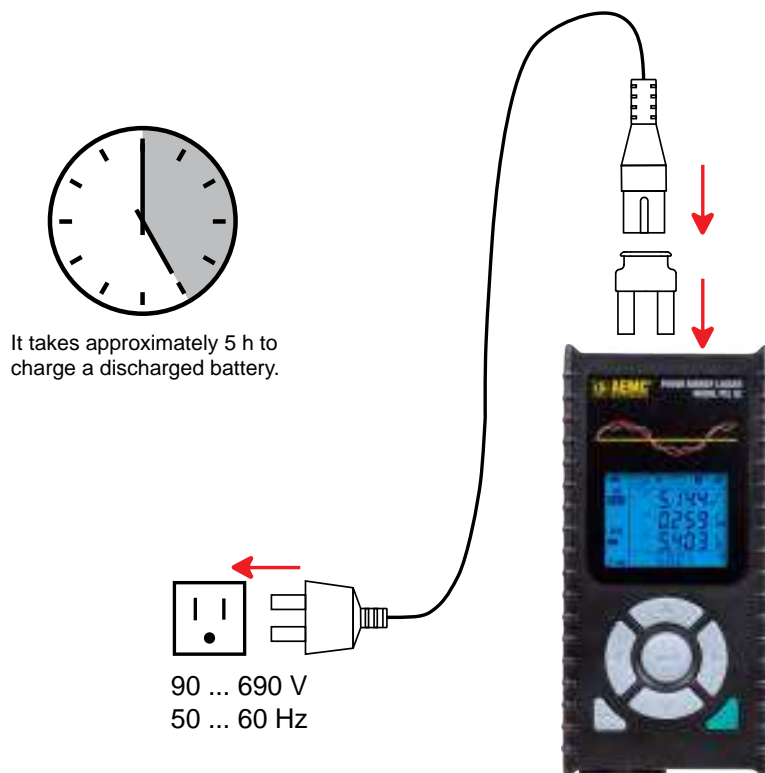



Figure 2

- Connect the C8 / banana adapter between the **V1** and **N** terminals.
- Plug the power cord into the adapter and into the wall outlet.
- The device will turn on.

When charging, the  symbol will blink and slowly fill up. When the  symbol is full and steady, the battery is fully charged.



**NOTE:** The battery will take approximately 5 h to fully charge.

---

## 2. PRODUCT FEATURES

---

### 2.1 DESCRIPTION

The Power & Energy Logger Model PEL 52 is an easy-to-use, single-phase, and two-phase **Power and Energy Logger**. The instrument has a large, backlit LCD display for crisp viewing and an SD card to store measurements. Designed to operate in 600 V CAT III or lower environments, the PEL records voltage, current, power, and energy on alternating current distribution networks (50 Hz or 60 Hz). The instrument is compact enough to fit into many different distribution panels, has a water and shock resistant housing, operates on phase 1 input, and has a backup battery that charges from the V1 input during measurements. The following measurements and calculations can be made:

- Phase-to-neutral and phase-to-phase voltage measurements up to 600 V
- Current measurements up to 25,000 A, current sensor dependent
- Automatic recognition of the different types of current sensors
- Frequency measurements
- Measurements of active power P (W), fundamental reactive power Q (var), and apparent power S (VA) power
- Measurements of fundamental active power Pf (W), non-active power N (var), and distorting power D (var) using the PEL Control Panel
- Measurements of active energy at source and load (W·h), reactive energy on 4 quadrants (varh), and apparent energy (VAh)
- Total energy meter
- Calculation of  $\cos \varphi$  and power factor (PF)
- Phase angle measurement
- Calculation of aggregations of values from 1 minute to 1 hour

In addition to the types of measurements, the PEL 52 offers the following features:

- Storage of values on SD or SDHC card
- Communication via Wi-Fi
- PEL Control Panel for data recovery, configuration, communication in real time with a PC, and Dataview® software for report generation and analyzing
- Web Server Interface which includes VNC mode function. When IP address is known, instrument status can be displayed from any web browser
- Connection to DataViewSync™ to communicate between private networks

## 2.2 INSTRUMENT FRONT PANEL



Figure 3

## 2.3 INSTRUMENT TERMINAL BLOCK

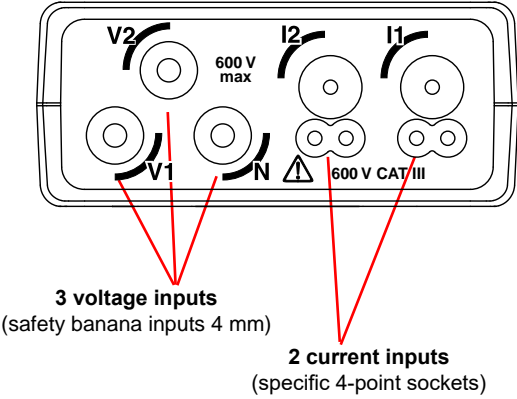

Figure 4

---

**NOTE:** Before connecting a current sensor, consult the sensor's corresponding safety data sheet or user manual. Also, the PEL must not be used when the SD card slot is open.

---

## 2.4 INSTRUMENT REAR PANEL



Figure 5

## 2.5 SD CARD SLOT

- Before opening the SD card slot, disconnect the device, and turn it off.
- To unlock the protective cover, turn the screw a quarter turn.
- Open the protective cover to access the SD card.
- To remove the SD card, press it in until you hear a click, and then release.
- To insert the SD card, hold the PEL device with front panel facing up. With the contacts on the SD card facing up and forward, gently push card straight into the card slot until you hear a click.

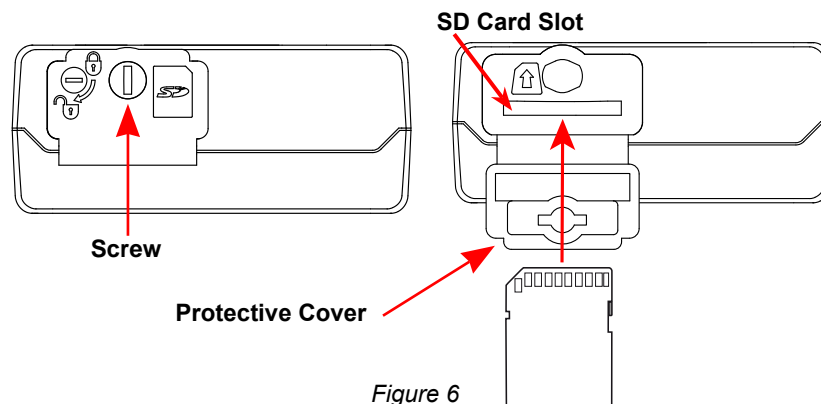

Figure 6

## 2.6 MOUNTING

The PEL must be placed in a well-ventilated room where the temperature must not exceed the values specified in § 6.5.

The PEL can be mounted on a flat, ferromagnetic surface using the magnets incorporated in the PEL's housing.



**NOTE:** The strong magnets can damage hard drives or medical devices.

---

## 2.7 BUTTON FUNCTIONS

Button	Description
	<b>ON / OFF Button</b> <ul style="list-style-type: none"><li>▪ A long press will turn the device ON or OFF.</li><li>▪ The device cannot be turned off while a recording is pending or in progress.</li></ul>
	<b>Select Button</b> <ul style="list-style-type: none"><li>▪ When pressed, this button allows the user to start or stop a recording and allows Wi-Fi mode to be chosen.</li></ul>
	<b>Navigation Buttons</b> <ul style="list-style-type: none"><li>▪ These buttons are used to configure the device and browse displayed data.</li></ul>
	<b>Enter Button</b> <ul style="list-style-type: none"><li>▪ In configuration mode, cycles through the available setting options and determines the applied setting.</li><li>▪ In measurement and power display modes, displays phase angles.</li><li>▪ In select mode, starts or stops a recording after the Select button is pressed. It also allows the type of Wi-Fi to be chosen.</li></ul>

*Table 1*

If any button is pressed, the backlight will turn on for 3 minutes.

## 2.8 LCD DISPLAY

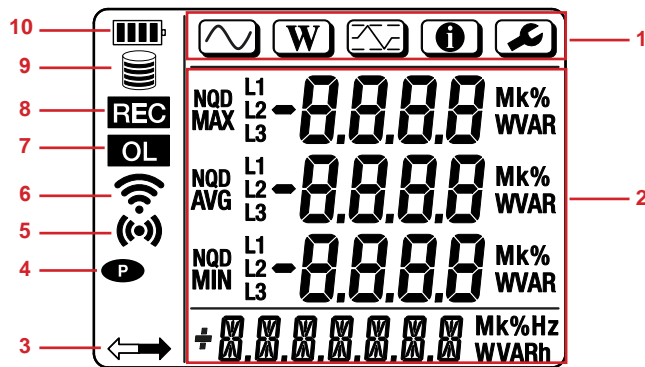







Figure 7

### 1. Mode indicators

-  Measurement mode (§ 4.3.1)
-  Power and Energy mode
-  MAX Mode (§ 4.3.3)
-  Information mode (§ 3.4)
-  Configuration mode (§ 3.2)

### 2. Display for data and messages

#### 3. Power

**ON:** Instrument is running on external USB power.

**Blinking:** Instrument is running on external USB power and communicating via USB.

**OFF:** Instrument is running on internal (battery) power.

#### 4. Permanent mode

**ON:** Permanent mode is enabled, so the instrument will not automatically power down.

**OFF:** Permanent mode is disabled, so the instrument will automatically power down after a period of inactivity as defined by the PEL Control Panel.

#### 5. Wi-Fi Direct

**ON (steady):** Wi-Fi Direct is enabled and not transmitting.

**Blinking:** Wi-Fi Direct is actively transmitting.

**OFF:** Wi-Fi Direct is disabled.



6. **Wi-Fi (router connection  )**

**ON (steady):** Wi-Fi connection is enabled and not transmitting.

**Blinking:** Wi-Fi is actively transmitting.

**OFF:** Normal Wi-Fi connection is disabled.

7. **Overload **

**ON:** At least one input is out of range and cannot be displayed.

**OFF:** All inputs are within range.

8. **Recording **

**ON (steady):** A recording is in progress.

**Blinking:** A recording is pending.

**Blinking (slowly):** A recording is in progress in extended recording mode.

**OFF:** A recording is neither scheduled nor in progress.

9. **Memory **

**Empty **: Instrument memory is empty.

**Partially filled **: Instrument memory is partially full.

**Filled **: Instrument memory is full. No recordings can be stored while the memory is full. To erase all memory use the Format SD Card button in the PEL Control Panel. The Delete Session Button can be used to erase selected recordings. For more information reference the Help File.

10. **Battery **

**Empty **: The battery must be charged.

**Partially filled **: The battery is partially charged.

**Filled **: The battery is fully charged.

**Blinking:** The battery is charging.

## 2.9 MEMORY CARD

The PEL accepts FAT32 formatted SD and SDHC cards with 32 GB or less. The SD card must be formatted as 32 GB on a PC.

The PEL is delivered with a formatted SD card. If you want to install a new SD card:

- Open the SD card slot protective cover marked **SD** (see § 2.5).
- Press the device's current SD card in until you hear a click. The device will release the SD card.
- Remove the SD card.



**NOTE:** Do not remove SD Card if a recording is in progress.

---

- Check that the new SD card is unlocked.

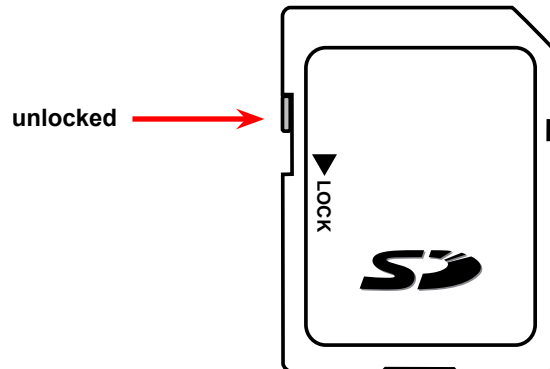

- Format the SD card. The PEL Control Panel is the best way to format the SD card; otherwise, format it using a PC.
- Insert the new SD card. Press it in all the way until you hear a click (see § 2.5).
- Close the SD card protective cover.

---

## 3. SETUP

---

The PEL must be configured before any recording. Follow the below steps to configure the PEL:

- Establish a Wi-Fi connection with the PC (to use the PEL Control Panel, see § 5).
- Select the connection according to the type of distribution network.
- Connect the current sensor(s).
- Define the nominal primary current according to the current sensor used.
- Select the aggregation period.

To configure the device, you can use the Configuration mode (see § 3.2) or the PEL Control Panel.



**NOTE:** To avoid accidental changes, the PEL cannot be configured while recording or if a recording is pending.

---

### 3.1 TURNING THE INSTRUMENT ON AND OFF

#### 3.1.1 Turning On

- Connect the PEL to Network between the **V1** and **N**, and it will turn on automatically. Otherwise, press and hold the **ON/OFF** button until the device turns on.

The battery will charge automatically when the PEL is connected to a voltage source between the **V1** and **N** terminals. Battery life is approximately one hour when fully charged. This allows the device to continue operating during brief power cuts.

#### 3.1.2 Auto Off

By default, the device operates in continuous mode, which is indicated by the **P** symbol.

When the device is running on battery power, you can choose to have it turn off automatically after a period with no keyboard activity and no recording in progress to save battery life. This time will be defined in the PEL Control Panel (see § 5).

#### 3.1.3 Turning Off



You cannot turn the PEL off while it is connected to a power source or while a recording is in progress or pending. This is a precaution intended to prevent a recording from being unintentionally stopped by the user.

To turn the PEL off:

- Disconnect the PEL.
- Press and hold the **ON/OFF** button until the device turns off.



### 3.1.4 Battery Operation

Powering the device from the network can disturb the in-progress measurement for certain applications, such as low fan-out generators.

To operate on the battery alone, press the  and  buttons simultaneously. The  symbol will blink.

## 3.2 CONFIGURING THE INSTRUMENT

Several main functions can be configured directly on the device. For full configuration, use the PEL Control Panel (see § 5) once Wi-Fi communication has been established.

To enter Configuration mode from the device, press the  or  buttons until the  symbol is selected.

The following screen is displayed:

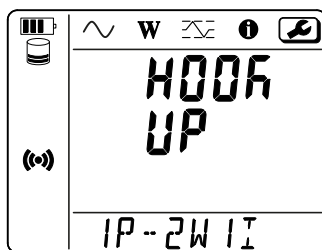



Figure 8



**NOTE:** If the PEL is already being configured from the PEL Control Panel, it is not possible to enter Configuration mode on the device. In this case, when an attempt is made to configure the device, the screen will display **LOCK**.

### 3.2.1 Network Type

To change the network, press the  button.

- **1P-2W1I:** Single-phase 2-wire with a current sensor
- **1P-3W2I:** Single-phase 3-wire (2 voltages in phase) with two current sensors
- **2P-3W2I:** Two-phase 3-wires (2 voltages in opposite phases) with two current sensors

### 3.2.2 Wi-Fi

From the initial screen, press the ▼ button to access the following screen.

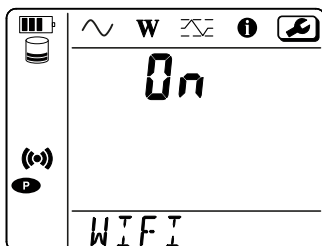

Figure 9



**NOTE:** For the Wi-Fi to operate, the battery must be sufficiently charged (■■■■ or ■■■■).

Press the ← button to activate or deactivate the Wi-Fi. The device will indicate if the battery is too low to enable Wi-Fi.

#### To establish a Wi-Fi connection

- Enable Wi-Fi.
- Then, this connection will let you connect your instrument to another device, such as a PC, smartphone, or tablet. The connection procedure is detailed below.

#### Wi-Fi access point connection procedure

The first connection must be made in Wi-Fi access point mode.

- Press the **Select** button first. The device will display **START REC. PUSH ENTER TO START RECORDING.**
- Press the **Select** button a second time, and the device will display **WIFI ST. PUSH ENTER FOR WIFI ST, WIFI OFF. PUSH ENTER FOR WIFI OFF or WIFI AP. PUSH ENTER FOR WIFI AP.**

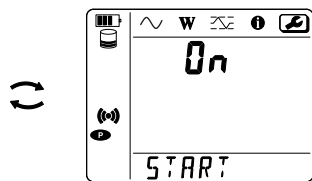

Figure 10

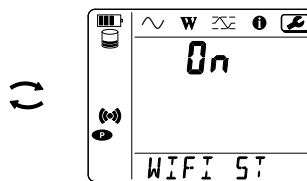

Figure 11

- Use the ← button to select **(W) WIFI AP.**

Your device's IP address is **192.168.2.1 3041 UDP** and is shown in the Information menu.

- Connect your PC to the device's Wi-Fi. In the Windows status bar, click the **connection symbol.**
- Select your device from the list.

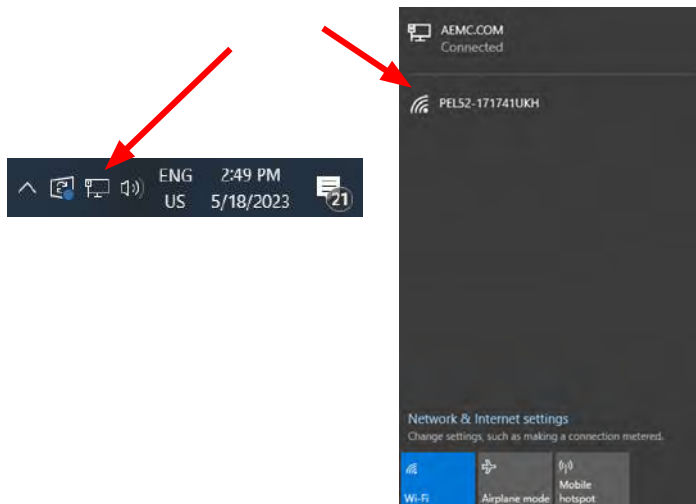

Figure 12

- Start the PEL Control Panel (see § 5).
- Go to **Instrument, Add an Instrument, PEL 52, to Wifi access point.**
- When you are connected to the PEL Control Panel, you will be able to:
  - Configure the device.
  - Access real-time measurements.
  - Download the recordings.
  - Change the access point SSID name and secure it with a password.
  - Enter the SSID and password for a Wi-Fi network to which the device can connect.
  - Enter the DataViewSync™ password. This allows the device to access separate private networks.

If the username and password are lost, you can reset them to the factory configuration (see § 3.2.5).

#### **Wi-Fi connection procedure (continued)**

Once your device is connected as a Wi-Fi access point, you can connect it to a Wi-Fi router. This will allow you to access your device from a smartphone, tablet, or even from DataViewSync™ through a public or private network.

## Configuration of the Wi-Fi router connection

- In the PEL Control Panel, go to the Configuration menu , **Communication** tab, and enter the network name (SSID) and password in the 'Wifi "Station" mode (STA)' dialog box, port 3041, UDP protocol.

The SSID is the name of your desired network, such as the network of your smartphone or tablet in access point mode.

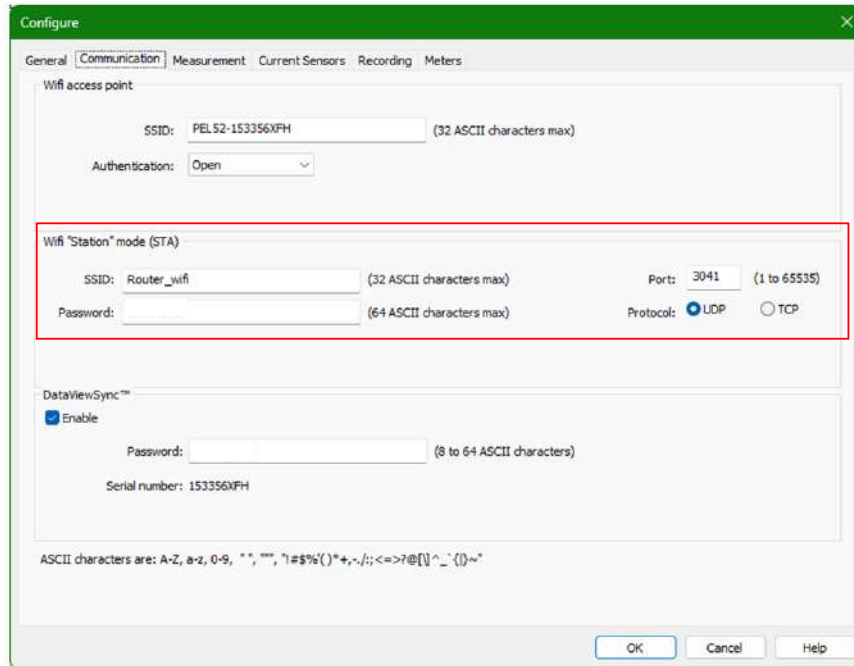







Figure 13

- Click **OK** to apply the configuration to the device.
- Press the **Select**  button twice and the Enter  button twice to switch to  **WIFI ST.**
  - Your device will connect to this Wi-Fi network.
  - The Wi-Fi access point connection will be lost.
  - Once the PEL is connected to the network, you can find the PEL's IP address in information mode .

- In the PEL Control Panel, change the connection  to Ethernet (LAN or Wi-Fi), and enter the IP address of your device, port 3041, UDP protocol. This lets you connect several PELs on the same network.

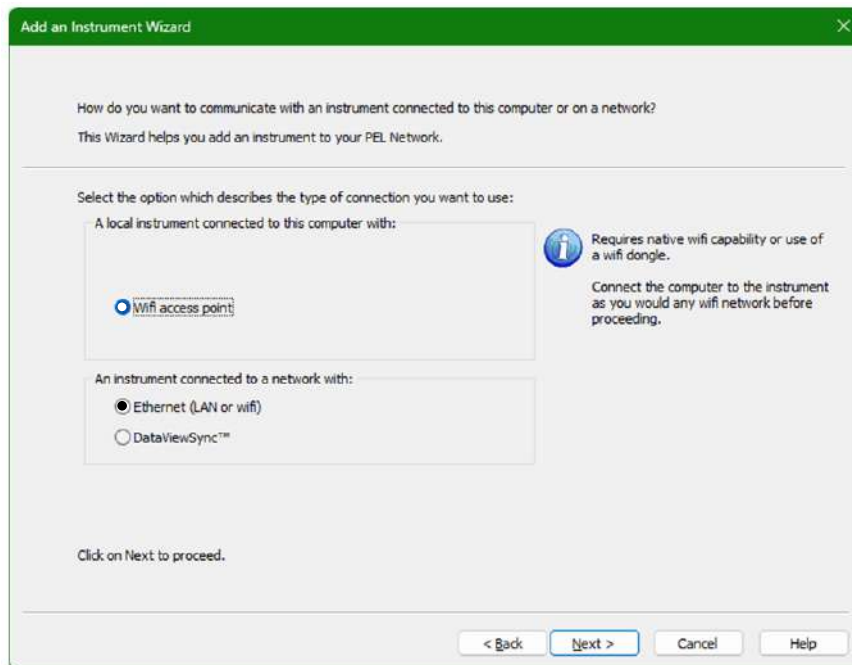



Figure 14

### Configuration of the DataViewSync™ connection

- To connect the PEL to DataViewSync™, the PEL must be in  **WIFI ST**, and the connected network must have internet access in order to access DataViewSync™.



- In the PEL Control Panel, go to the Configuration menu  and then the Communication tab. Enable DataViewSync™, and enter the password that will be used to connect afterwards.

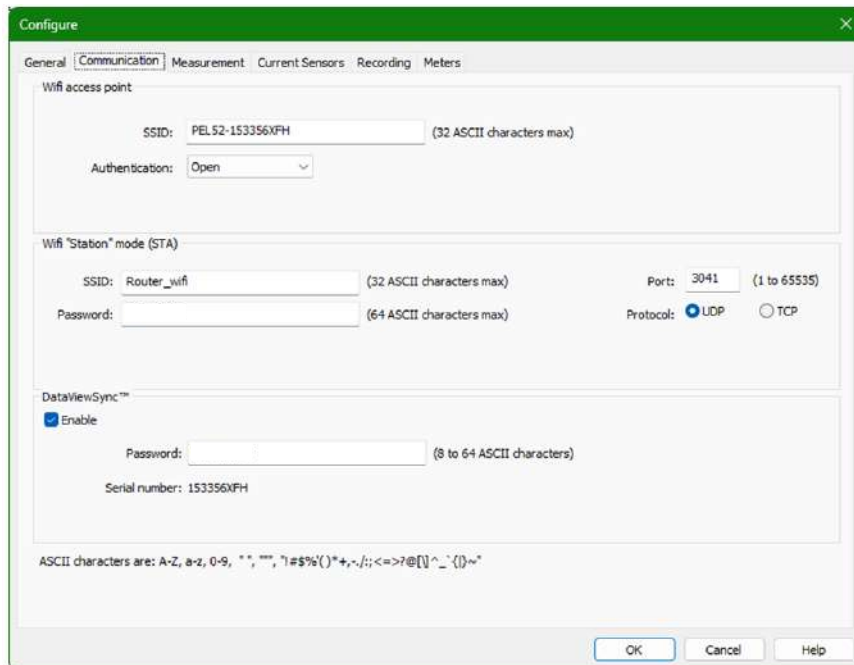

Figure 15

### 3.2.3 Nominal Primary Current

- From the Wi-Fi screen, press the ▼ button to access the following screen.

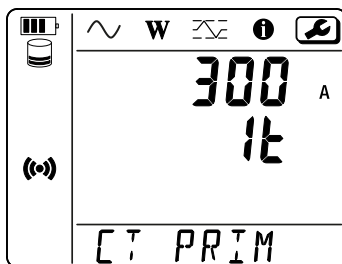



Figure 16

- Connect the current sensor(s).
- The current sensor is automatically detected by the device.
- If two current sensors are connected, they must be identical.
- For AmpFlex® or MiniFlex® sensors, press the  button to select 300 A or 3000 A.

The nominal currents of current sensors are as follows:

Sensor	Nominal current	Choice of gain	Number of turns
SR193 clamp	1000 A	-	-
AmpFlex® 193 MiniFlex® MA193 MA194	(300 or 3000) A	✓	1, 2, or 3 to be configured in PEL Control Panel
MN193 clamp 5 A range	5 A	to be configured in PEL Control Panel	-
MN193 clamp 100 A range	100 A	-	-
MN93 clamp	200 A	-	-
MN94 clamp	200 A	-	-

Table 2

### 3.2.4 Aggregation Period

- From the nominal primary current screen, press the ▼ key to access the following screen.

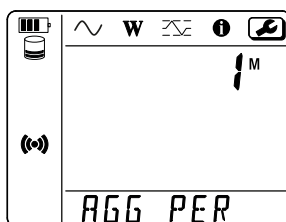

Figure 17

- To change the aggregation period, press the ← key: 1, 2, 3, 4, 5, 6, 10, 12, 15, 20, 30, or 60 minutes.

### 3.2.5 Reset

- From the aggregation period screen, press the ▼ key to access the following screen.

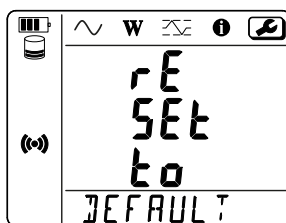

Figure 18

- To reset the device to the default Wi-Fi configuration (direct Wi-Fi, password deleted), press the ← key.

- It is possible to reset the Wi-Fi settings and other settings in the Set-up menu.

The default settings are:

<b>AP Mode:</b>	- SSID = PEL52-[serial_number] - Authentication = Open
<b>WIFI Mode:</b>	- No SSID - No Password - Protocol = UDP - Port = 3041
<b>DataViewSync™:</b>	- Enabled NOTE the DataViewSync™ password is not reset
<b>Remote Password Protection:</b>	- No password protection
<b>SELECT Button:</b>	- Unlocked
<b>Recording:</b>	- Reset during recordings in progress is not possible (set-up is locked).

- The device will ask for confirmation before performing the reset. Press the ← button to confirm or any other button to cancel.

### 3.3 REMOTE USER INTERFACE

The remote user interface runs on a PC, tablet or smartphone. It allows you to view device information.

- Enable Wi-Fi on the PEL. The remote user interface can work with an access point Wi-Fi (📶) link or a router Wi-Fi (📶) link but not a DataViewSync™ link.
- On a PC, connect as indicated in § 3.2.2.
- On a tablet or smartphone, share a Wi-Fi connection.
- In an Internet browser, enter `http://device_IP_address`.
- For a Wi-Fi access point (📶) connection, enter <http://192.168.2.1>
- For a Wi-Fi router (📶) connection, this address is indicated in the information menu (see § 3.4).

The following screen will be displayed:



Figure 19



**NOTE:** Refreshing the display is not automatic. You need to do this regularly.

On the second tab, measurements can be viewed:



Figure 20

On the 3rd tab, the device information is displayed:

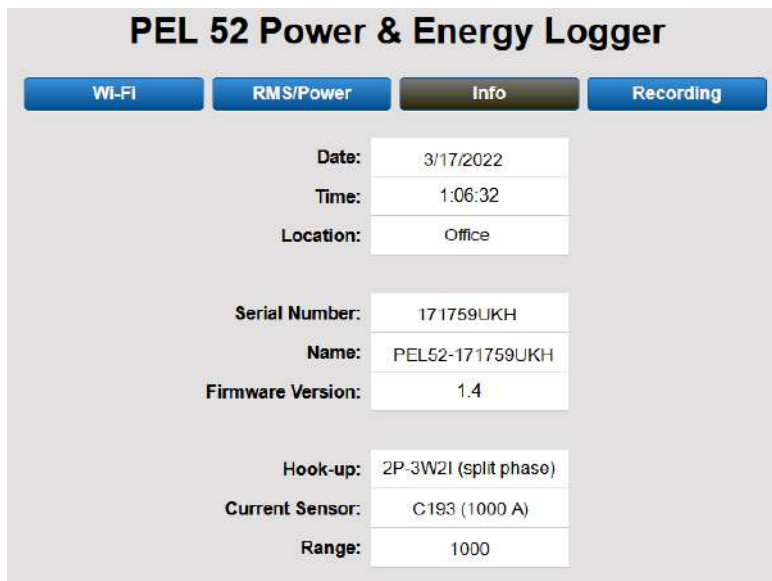

Figure 21

On the 4th tab, information on the current or last recording made can be viewed:

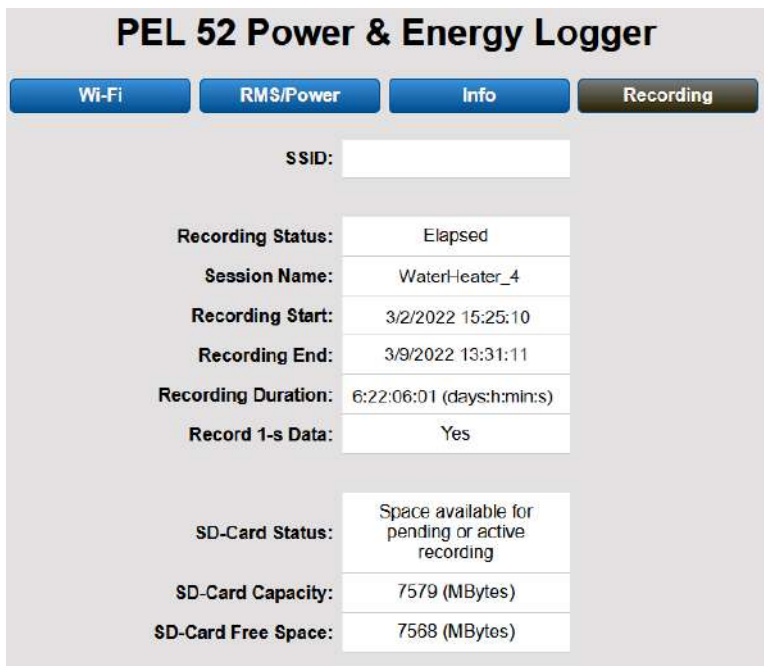
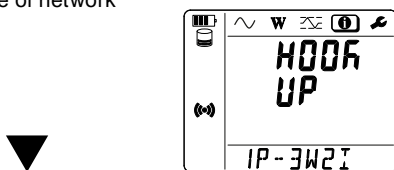

Figure 22

### 3.4 INFORMATION

- To enter Information mode, press the ◀ or ▶ buttons until the ⓘ symbol is selected.
- Using the ▲ and ▼ keys, scroll through the device information:
  - Type of network



- Nominal primary current and number of turns: 1t, 2t or 3t (to be defined via PEL Control Panel for Flex type current sensors)

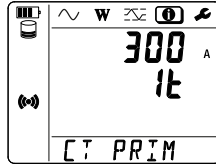

- SR193 clamp: 1000 A
- AmpFlex® or MiniFlex®: 300 A or 3000 A
- MN193 clamp 5 A range: 5 A modifiable
- MN193 clamp 100 A range: 100 A
- MN93 clamp: 200 A
- MN94 clamp: 200 A



- Aggregation period

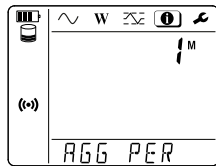

- Date  
Year, month, day

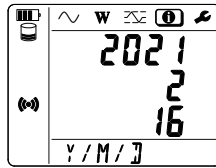

- Time  
Hour, minute, second

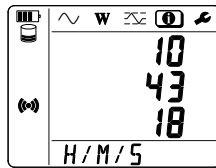

- IP address  
(scrolling)

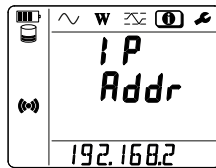

- Firmware version and scrolling serial number

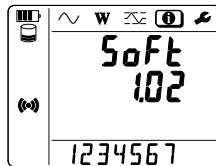

After configuration is complete, the instrument is ready for use.

---

## 4. OPERATION

---

### 4.1 DISTRIBUTION NETWORKS & CONNECTIONS OF THE PEL

Connect the current sensors and voltage measurement leads on your installation according to the type of distribution network.



**NOTE:** Always check that the arrow on the current sensor points toward the load. If so, the phase angle will be correct for power measurements and other phase dependent measurements. Otherwise, the PEL Control Panel allows a current sensor's phase to be reversed under certain conditions.

#### 4.1.1 Single-Phase 2-wire: 1P-2W1

For single-phase 2-wire measurements:

- Connect the N measuring lead to the neutral conductor.
- Connect the V1 measuring lead to the L1 phase conductor.
- Connect the I1 current sensor to the L1 phase conductor.

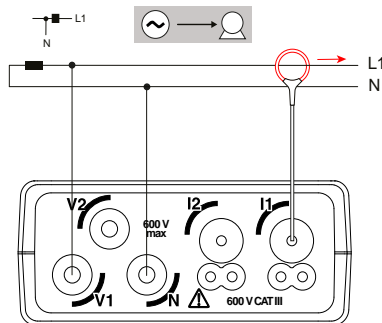

Figure 23

#### 4.1.2 Single-Phase 3-wire 2-currents: 1P-3W2I

For single-phase 3-wire measurements with 2 current sensors:

- Connect the N measuring lead to the neutral conductor.
- Connect the V1 measuring lead to the L1-I1 phase conductor.
- Connect the V2 measuring lead to the L1-I2 phase conductor.
- Connect the I1 current sensor to the L1-I1 phase conductor.
- Connect the I2 current sensor to the L1-I2 phase conductor.

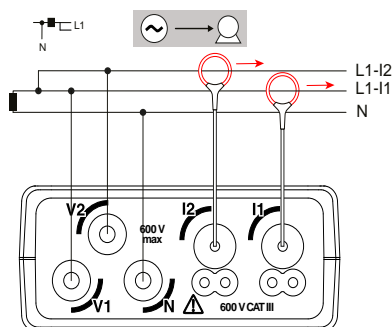

Figure 24

#### 4.1.3 Two-Phase 3-wire (two-phase from a mid-tap transformer): 2P-3W2I

For two-phase 3-wire measurements with 2 current sensors:

- Connect the N measuring lead to the neutral conductor.
- Connect the V1 measuring lead to the L1 phase conductor.
- Connect the V2 measuring lead to the L2 phase conductor.
- Connect the I1 current sensor to the L1 phase conductor.
- Connect the I2 current sensor to the L2 phase conductor.

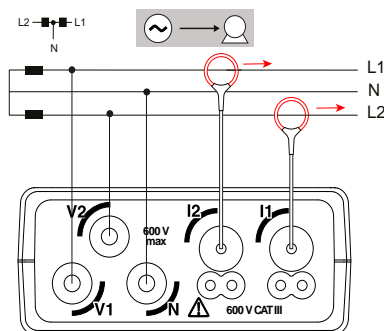



Figure 25





## 4.2 RECORDING

To start a recording:

- Check that there is an unlocked SD card (see § 2.9) in the PEL with sufficient memory space.
- Press the **Select**  button first. The device will display **START** if the device is able to make recordings.



**NOTE:** If the device displays **INSERT SD CARD**, there is no SD card in the device. If it displays **SD CARD WRITE PROTECT**, the SD card is locked. If either message is displayed, recordings cannot be made.



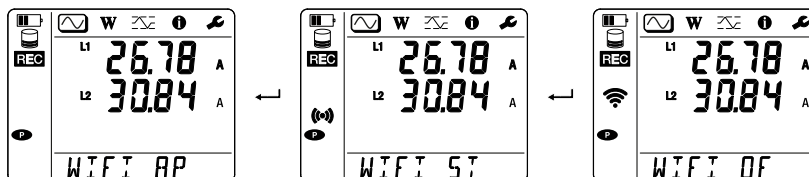

- Use the  button to start the recording. The **REC** symbol will blink a few times before turning solid.
- Use the  button to stop the recording. The **REC** symbol will disappear.

Recordings can be managed from the PEL Control Panel as well (see § 5).

While recording, the device configuration cannot be modified. To enable or disable Wi-Fi, press the **Select**  button twice and then press the Enter  button to choose **WIFI AP** , **WIFI ST** , or no Wi-Fi, **WIFI OFF**.



## 4.3 MEASURED VALUE DISPLAY MODES

The PEL has 3 measurement display modes, Measurement Mode , Energy Mode , and Maximum Mode , represented by the icons at the top of the display. To switch from one mode to another, use the  or  keys.

The displays can be accessed as soon as the PEL is turned on but the values will be zero. The values will update when voltage or current is present at the inputs.

### 4.3.1 Measurement Mode

This mode displays the instantaneous values: voltage (V), current (I), active power (P), reactive power (Q), apparent power (S), frequency (f), power factor (PF), and phase shift ( $\phi$ ).

The display depends on the configured network. Press the  $\blacktriangledown$  key to switch from one screen to the next.

#### Single-phase 2-wire (1P-2W1I)v

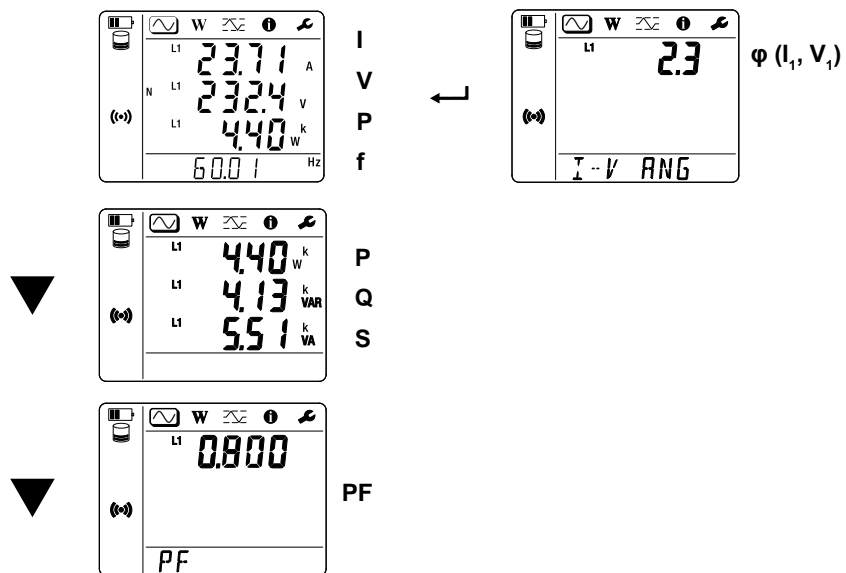

If the current sensor is not detected, all the quantities that depend on the current (current, angle, powers, PF) are undefined (displays - - - -).

Single-phase 3-wire 2-currents (1P-3W2I) and two-phase 3-wire (2P-3W2I).

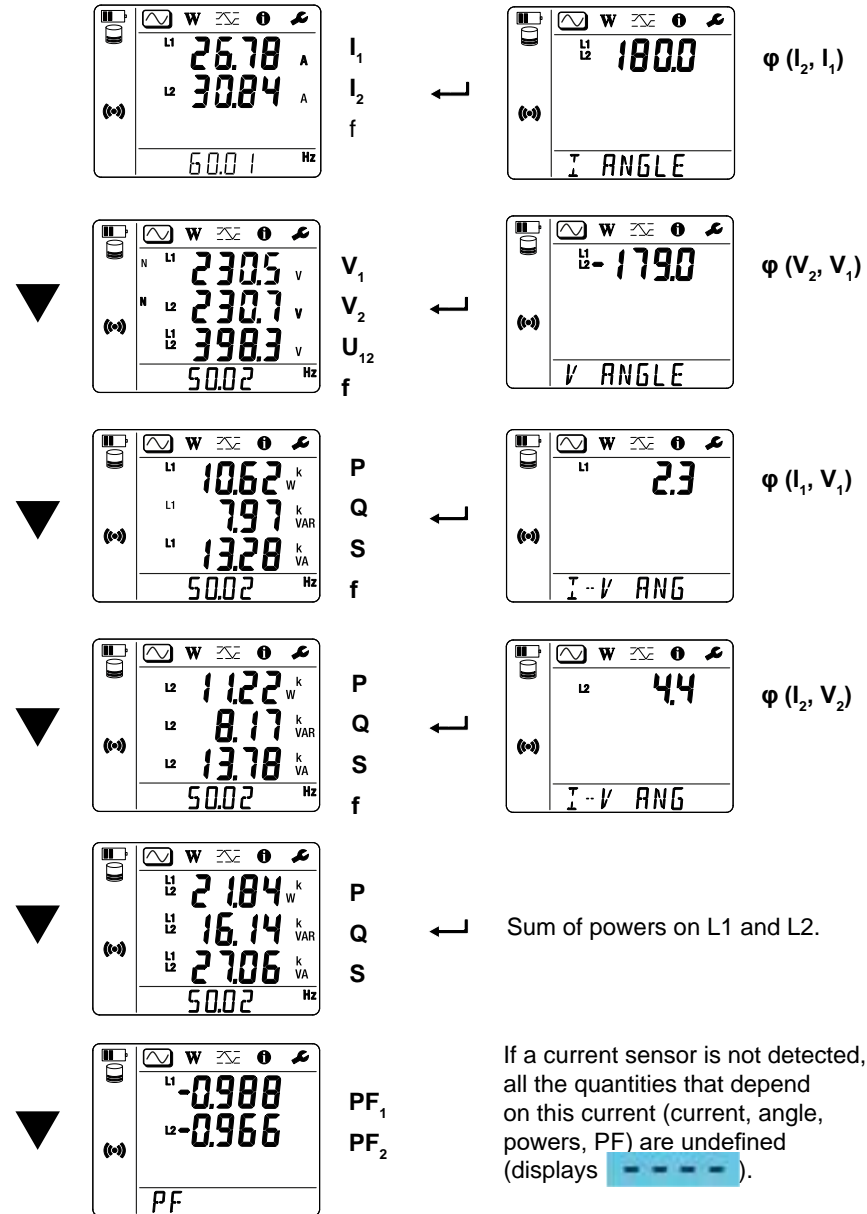

### 4.3.2 Energy Mode

This mode displays the energy: active energy (Wh), reactive energy (varh), apparent energy (VAh).

The energies displayed are the total energies of the source or of the load. The energy depends on the duration.

Press the ▼ key to switch from one screen to the next. You will scroll successively:

- Ep+: Total active energy consumed (by the load) in Wh
- Ep-: Total active energy supplied (by the source) in Wh
- Eq1: Reactive energy consumed (by the load) in the inductive quadrant (quadrant 1) in varh.
- Eq2: Reactive energy supplied (by the source) in the capacitive quadrant (quadrant 2) in varh.
- Eq3: Reactive energy supplied (by the source) in the inductive quadrant (quadrant 3) in varh.
- Eq4: Reactive energy consumed (by the load) in the capacitive quadrant (quadrant 4) in varh.
- Es+: Total apparent energy consumed (by the load) in VAh
- Es-: Total apparent energy supplied (by the source) in VAh



**NOTE:** The device does not display the “h” symbol. Therefore, you will see “W” for “Wh”.

---

### 4.3.3 Maximum Mode

This mode displays the maximum values: maximum aggregated values of measurements and energy.

Depending on the option selected in the PEL Control Panel, these may be the maximum aggregated values for the recording in progress or the maximum aggregated values of the last recording, or the maximum aggregated values since the last reset to zero.

#### Single-phase 2-wire (1P-2W1I)

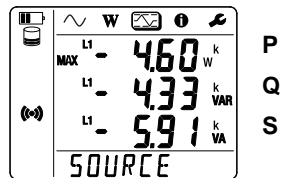
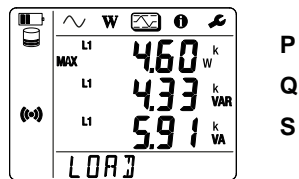
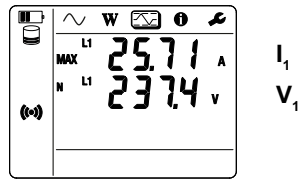

Single-phase 3-wire 2-currents (1P-3W2I) and two-phase 3-wire (2P-3W2I)

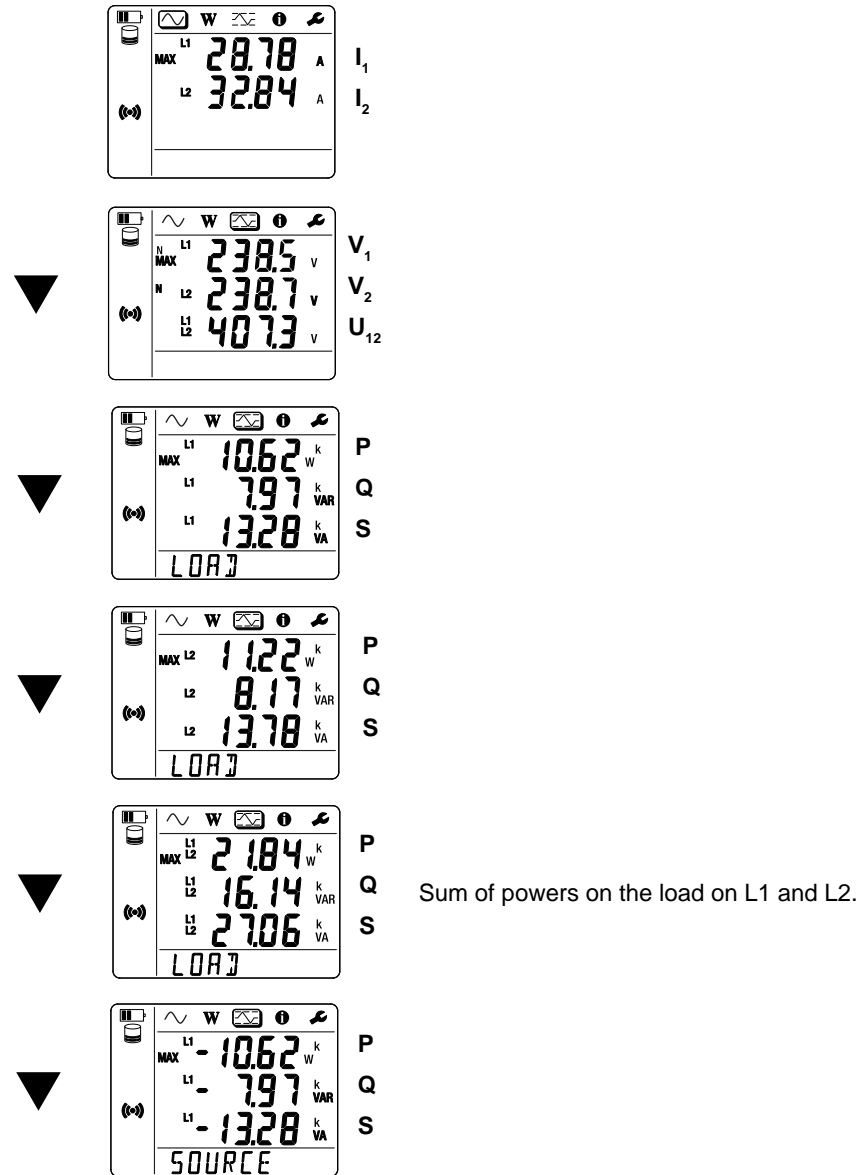

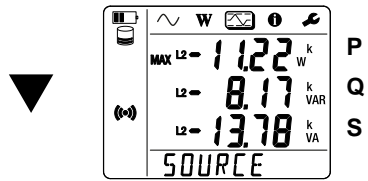

P  
Q  
S

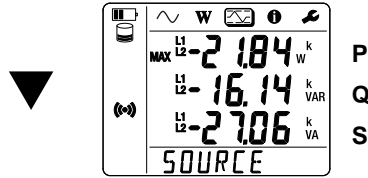

P  
Q  
S

Sum of powers on the source on L1 and L2.

---

## 5. PEL CONTROL PANEL - DATAVIEW®

---

### 5.1 INSTALLING DATAVIEW®



**NOTE:** For contextual information on using DataView®, refer to the Help Menu within the DataView® software.

---

When you purchase the instrument, the product package includes a USB thumb drive containing DataView® program files.

To begin installation:

1. Insert the DataView® thumb drive into an available USB port on your computer. If Autorun is enabled, an AutoPlay window appears on your screen. Click **Open folder to view files** to display the DataView® folder. If Autorun is not enabled or allowed, use Windows Explorer to locate and open the USB drive labeled “DataView.”
2. When the DataView® folder is open, find the **Setup.exe** file located in the root directory of the USB drive, and **double-click** it to run the installation program.
3. The DataView® setup screen appears.

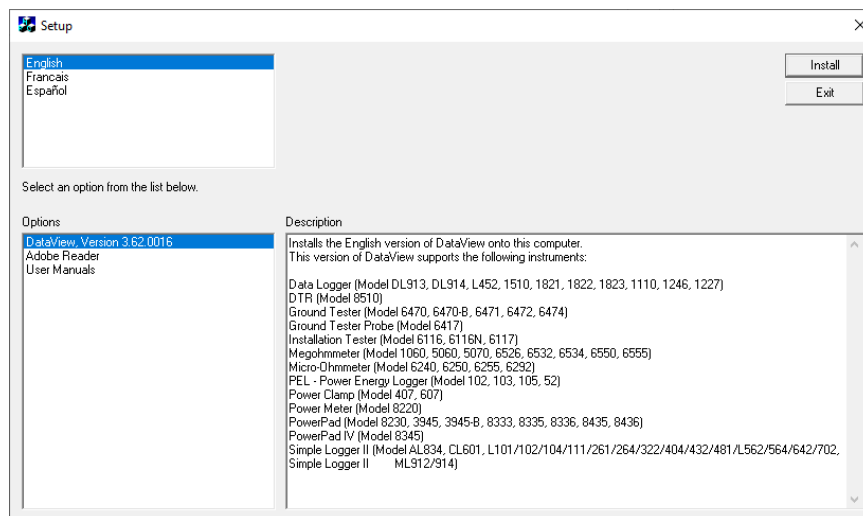

Figure 26



In the upper left corner of the screen, choose the language version of the Setup interface. (All Setup screens and dialogs will immediately appear in the selected language.)

In the lower left corner are the available installation options. In addition to the DataView® software, you can select "Adobe Reader." This links to the Adobe web site where you can download the latest version of Reader. This program is recommended to view DataView.pdf documents.

The option Firmware Upgrades links to the website where you can check for new firmware updates for the PEL.

Finally, the option User Manuals displays a list of .pdf files contained in the USB drive that accompanies DataView®. (DataView® also comes with a Help system that is installed with the program files.)

To install DataView®, select DataView in the Options list and click **Install**.

4. Select the language version of DataView® you want to install (English, French, or Spanish) then click **Next**. (By default, the language selected in step 3 is highlighted.)

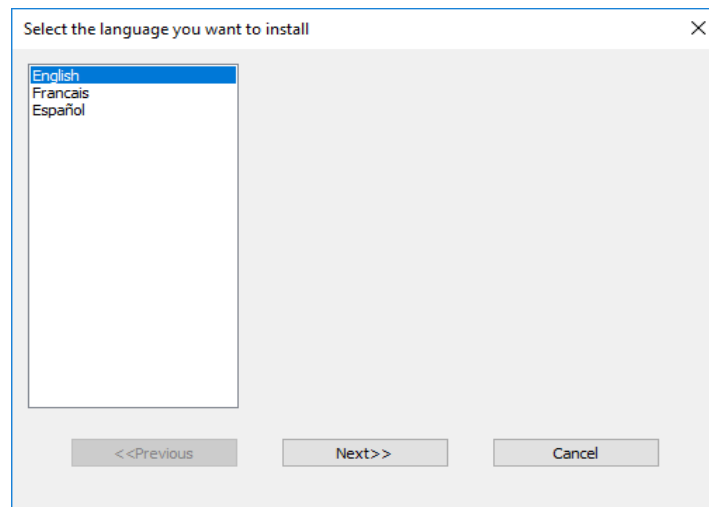

Figure 27

5. You are now prompted to select the software you want to install.

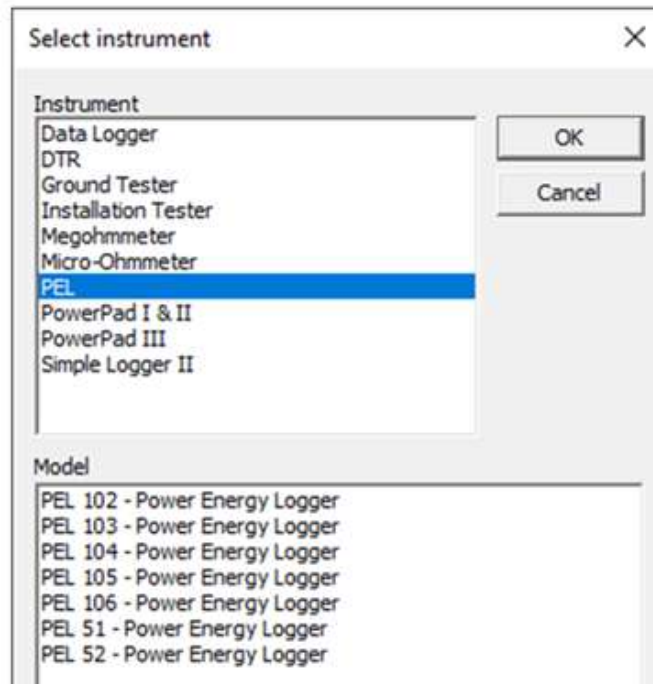

Figure 28

Each AEMC® Instruments product family has their own specially designed Control Panel. If you are performing a Complete install, by default all available Control Panels are selected (a check mark next to the Control Panel indicates it is selected). Control Panels take up disk space on the computer; so unless you have other types of AEMC® instruments, we recommend that you select **Power Energy Logger (PEL)** and deselect the rest. You should also check the option DataView Core, which is a requirement if you plan to create DataView® reports.

After you finish selecting and deselecting Control Panels and/or DataView Core, click **Next**.

6. The Setup program now informs you that it is ready to install DataView®. If you want to review any of your previous selections, click the **Previous** button to return to earlier screens. Otherwise, click **Install** to begin installation.

7. The InstallShield program installs the selected software. If an earlier version of the software is already installed on your computer, for each selected program the InstallShield program will:
  - (a) Ask you to confirm the installation of the program. Click **Next**.
  - (b) Display a status bar indicating the progress of the installation.
  - (c) Inform you when the program is installed. Click **Finish** to install the next selected program.

If the software is not installed (or if the installed software is the same version as the selected software), the software is installed without requesting confirmation.

When all programs are installed, a message appears informing you of this. Click **Finish** to return to the Setup screen.

8. You can now select additional Setup options to install (see step 3 above). When finished, click **Exit**.
9. The DataView® folder now appears on your computer desktop, within which is the PEL Control Panel icon  and the icon(s) for any other Control Panel(s) you have installed.
10. A warning message similar to the one below will appear. Click **OK**.

There is no USB connection on the PEL 52, therefore ignore this automatic message that applies to other devices in the PEL range.

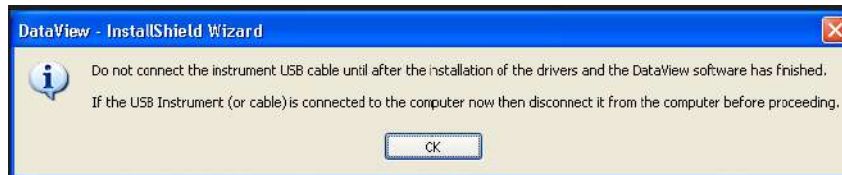



Figure 29

A shortcut has been added to your desktop  or DataView® directory. You can now open PEL Control Panel and connect your PEL to the computer.

## 5.2 PEL CONTROL PANEL

Clicking the DataView® icon in the DataView® folder on your desktop opens the core DataView® program. Clicking the PEL Control Panel icon opens the PEL Control Panel:



*Figure 30*

In general, core DataView® features are for creating, viewing, editing, and storing DataView® reports; while the PEL Control Panel is for connecting to, configuring, viewing measurements on, and downloading data from the instrument. You can access all DataView® features through either the DataView® icon or the Control Panel icon. For users who interact with PEL 100 series instruments, we recommend primarily using the PEL Control Panel. However, there are situations where using the core DataView® icon may be more convenient for some users, such as when viewing multiple archived reports from different AEMC® Instruments product families.

For further information about using the PEL Control Panel, consult the Help system that comes with the product. To access Help, **click** the option **Help** in the PEL Control Panel's menu bar at the top of the screen.

---

## 6. SPECIFICATIONS

---

### 6.1 REFERENCE CONDITIONS

Parameter	Reference conditions
Ambient temperature	(73.4 ± 3.6) °F (23 ± 2) °C
Relative humidity	(45 to 75) % RH
Voltage	No DC component.
Current	No DC component.
Phase voltage	[100 VRMS; 600 VRMS] without DC (< 0.5 %)
Input voltage of current inputs (except AmpFlex®/Min/Flex®)	[50 mV; 1.2 V] without DC (< 0.5 %)
Network frequency	(50 ± 0.1) Hz and (60 ± 0.1) Hz
Harmonics	< 0.1 %
Preheating	The device must have been powered up for at least one hour.
Common mode	The neutral input and the casing are grounded.
	The device is powered by the battery.
Magnetic field	0 A/m AC
Electrical field	0 V/m AC

Table 3

### 6.2 ELECTRICAL PROPERTIES

Uncertainties are expressed in % of reading (R) and an offset: ± (a % R + b).

#### 6.2.1 Voltage Inputs

**Operating range:** Up to 600 VRMS for phase-neutral and phase-phase voltages from (45 to 65) Hz.



**NOTE:** Phase-to-neutral voltages less than 2 V and 1200 VRMS for phase-to-phase voltages less than 3.4 V are set to zero.

**Input impedance:** 903 K when the device is running on battery.

When the device is powered by the voltage at the terminals, the impedance on L1 is dynamic and the current source must be able to deliver up to 100 mA at 90 V and 500 mA at 600 V.

**Sustained overload:** 660 V. Above 690 V, the device will display the **OL** symbol.

## 6.2.2 Current Inputs



**NOTE:** The outputs from current sensors are voltages.

**Operating range:** 0.5 mV to 1.7 V<sub>PEAK</sub>

**Peak factor:**  $\sqrt{2}$  except AmpFlex® / MiniFlex® current sensors (see Table 16)

**Input impedance:** 1 M $\Omega$  (except AmpFlex® / MiniFlex® current sensors)  
12.4 k $\Omega$  (AmpFlex® / MiniFlex® current sensors)

**Maximum overload:** 1.7 V

### 6.2.3 Intrinsic Uncertainty (Excluding Current Sensors)

With:

- R: displayed value.
- $I_{nom}$ : nominal current of the current sensor for an output of 1 V, see Table 14 and Table 16.
- $P_{nom}$  and  $S_{nom}$ : active and apparent power for  $V = 230$  V,  $I = I_{nom}$  and PF = 1.
- $Q_{nom}$ : reactive power for  $V = 230$  V,  $I = I_{nom}$  and  $\sin \varphi = 0.5$ .

#### 6.2.3.1 Specifications of the PEL

Quantities	Measurement range	Intrinsic uncertainty
Frequency (f)	[45 Hz; 65 Hz]	$\pm 0.1$ Hz
Phase-neutral voltage ( $V_1, V_2$ )	[10 V; 600 V]	$\pm 0.2$ % R $\pm 0.2$ V
Phase-phase voltage ( $U_{12}$ )	[20 V; 1200 V]	$\pm 0.2$ % R $\pm 0.4$ V
Current ( $I_1, I_2$ )	[0.2 % $I_{nom}$ ; 120 % $I_{nom}$ ]	$\pm 0.2$ % R $\pm 0.02$ % $I_{nom}$
Active power ( $P_1, P_2, P_T$ ) kW	PF = 1 V = [100 V; 600 V] I = [5 % $I_{nom}$ ; 120 % $I_{nom}$ ]	$\pm 0.3$ % R $\pm 0.003$ % $P_{nom}$
	PF = [0.5 inductive; 0.8 capacitive] V = [100 V; 600 V] I = [5 % $I_{nom}$ ; 120 % $I_{nom}$ ]	$\pm 0.7$ % R $\pm 0.007$ % $P_{nom}$

Quantities	Measurement range	Intrinsic uncertainty
Reactive power ( $Q_1, Q_2, Q_T$ ) kvar	Sin $\phi$ = [0.8 inductive; 0.6 capacitive] V = [100 V; 600 V] I = [5 % $I_{nom}$ ; 10 % $I_{nom}$ ]	$\pm 2 \% R \pm 0.02 \% Q_{nom}$
	Sin $\phi$ = [0.8 inductive; 0.6 capacitive] V = [100 V; 600 V] I = [10 % $I_{nom}$ ; 120 % $I_{nom}$ ]	$\pm 1 \% R \pm 0.01 \% Q_{nom}$
Apparent power ( $S_1, S_2, S_T$ ) kVA	V = [100 V; 600 V] I = [5 % $I_{nom}$ ; 120 % $I_{nom}$ ]	$\pm 0.3 \% R \pm 0.003 \% S_{nom}$
Power factor ( $PF_1, PF_2, PF_T$ )	PF = [0.5 inductive; 0.5 capacitive] V = [100 V; 600 V] I = [5 % $I_{nom}$ ; 120 % $I_{nom}$ ]	$\pm 0.02$
	PF = [0.2 inductive; 0.2 capacitive] V = [100 V; 600 V] I = [5 % $I_{nom}$ ; 120 % $I_{nom}$ ]	$\pm 0.05$
Cos $\phi$ ( $Cos \phi_1, Cos \phi_2, Cos \phi_T$ )	Cos $\phi$ = [0.5 inductive; 0.5 capacitive] V = [100 V; 600 V] I = [5 % $I_{nom}$ ; 120 % $I_{nom}$ ]	$\pm 0.05$
	Cos $\phi$ = [0.2 inductive; 0.2 capacitive] V = [100 V; 600 V] I = [5 % $I_{nom}$ ; 120 % $I_{nom}$ ]	$\pm 0.1$
Active energy ( $Ep_1, Ep_2, Ep_T$ ) kWh	PF = 1 V = [100 V; 600 V] I = [5 % $I_{nom}$ ; 120 % $I_{nom}$ ]	$\pm 0.5 \% R$
	PF = [0.5 inductive; 0.8 capacitive] V = [100 V; 600 V] I = [5 % $I_{nom}$ ; 120 % $I_{nom}$ ]	$\pm 0.6 \% R$

Quantities	Measurement range	Intrinsic uncertainty
Reactive energy (Eq <sub>1</sub> , Eq <sub>2</sub> , Eq <sub>T</sub> ) kvarh	Sin φ = [0.8 inductive; 0.6 capacitive] V = [100 V; 600 V] I = [5 % I <sub>nom</sub> ; 10 % I <sub>nom</sub> ]	± 2.5 % R
	Sin φ = [0.8 inductive; 0.6 capacitive] V = [100 V; 600 V] I = [10 % I <sub>nom</sub> ; 120 % I <sub>nom</sub> ]	± 1.5 % R
Apparent energy (Es) kVAh	V = [100 V; 600 V] I = [5 % I <sub>nom</sub> ; 120 % I <sub>nom</sub> ]	± 0.5 % R

Table 4

Internal clock: ± 20 ppm

## 6.2.4 Current Sensors

### 6.2.4.1 Precautions For Use



**NOTE:** Refer to the safety data sheet provided or the downloadable user manual.

Current clamps and flexible current sensors are used to measure the current flowing in a cable without opening the circuit.

They also isolate the user from dangerous voltages present in the circuit.

The choice of the current sensor to use depends on the current to be measured and the diameter of the cables. When installing current sensors, point the arrow on the sensor towards the load.

When a current sensor is not connected, the device displays .



### 6.2.4.2 Characteristics

The measurement ranges are those of the current sensors. Sometimes they may differ from the ranges measurable by the PEL.

#### a) MiniFlex® MA193

MiniFlex® MA193	
Nominal range	300 / 3000 AAC
Measurement range	0.4 A to 360 AAC for the 300 A range 2 A to 3600 AAC for the 3000 A range
Maximum clamping diameter	Length = 10 in (250 mm); Ø = 2.75 in (70 mm) Length = 14 in (350 mm); Ø = 3.9 in 100 (mm)
Influence of the conductor's position in the sensor	≤ 2.5 %
Influence of an adjacent conductor carrying an AC current	> 40 dB typical at 50/60 Hz for a conductor in contact with the sensor and > 33 dB near the latching mechanism
Safety	IEC/EN 61010-2-032 or BS EN 61010-2-032, pollution degree 2, 600 V CAT IV or 1000 V CAT III
	

Table 5

#### b) MiniFlex® MA194

MiniFlex® MA194	
Nominal range	300 / 3000 AAC
Measurement range	0.4 A to 360 AAC for the 300 A range 2 A to 3600 AAC for the 3000 A range
Maximum clamping diameter	Length = 24 in (609 mm); Ø = 7.4 in (190 mm)
Influence of the conductor's position in the sensor	≤ 2.5 %
Influence of an adjacent conductor carrying an AC current	> 40 dB typical at 50/60 Hz for a conductor in contact with the sensor and > 33 dB near the latching mechanism
Safety	IEC/EN 61010-2-032 or BS EN 61010-2-032, pollution degree 2, 600 V CAT IV, 1000 V CAT III
	

Table 6

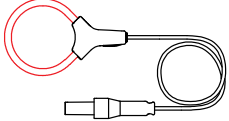

**NOTE:** Currents < 0.4 A for the 300 A range and < 2 A for the 3000 A range are set to zero.

c) AmpFlex® 193

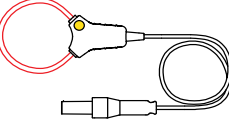
<b>AmpFlex® 193</b>	
Nominal Range	300 / 3000 AAC
Measurement range	0.4 A to 360 AAC for the 300 A range 2 A to 3600 AAC for the 3000 A range
Maximum clamping diameter (depending on the model)	Length = 24 in (610 mm); Ø = 7.64 in (190 mm) Length = 36 in (910 mm); Ø = 11.46 in (290 mm)
Influence of conductor's position in the sensor	≤ 2 % everywhere and ≤ 4 % near the latching mechanism
Influence of an adjacent conductor carrying an AC current	> 40 dB typical at 50/60 Hz everywhere and > 33 dB near the latching mechanism
Safety	IEC/EN 61010-2-032 or BS EN 61010-2-032, pollution degree 2, 600 V CAT IV, 1000 V CAT III
	

Table 7



**NOTE:** Currents < 0.4 A for the 300 A range and < 2 A for the 3000 A range are set to zero.

**d) SR193 clamp**

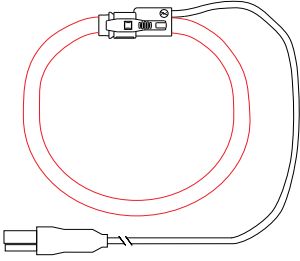
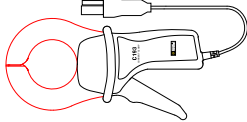
<b>SR193 clamp</b>	
Nominal range	1000 Aac
Measurement range	0.5 A to 1200 Aac (I >1000 A for 5 minutes maximum)
Maximum clamping diameter	2.04 in (52 mm)
Influence of the conductor's position in the clamp	< 0.1 % from DC to 440 Hz
Influence of an adjacent conductor carrying an AC current	> 40 dB typical at 50/60 Hz
Safety	IEC/EN 61010-2-032 or BS EN 61010-2-032, pollution degree 2, 600 V CAT IV, 1000 V CAT III
	

*Table 8*



**NOTE:** Currents < 0.5 A are set to zero.

**e) MN93 clamp**

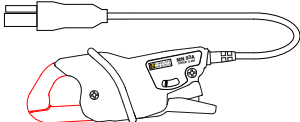
<b>MN93 clamp</b>	
Nominal range	200 Aac for f ≤1 k Hz
Measurement range	0.5 A to 240 Aac max (I >200 A non-continuous)
Maximum clamping diameter	.78 in (20 mm)
Influence of the conductor's position in the clamp	< 0.5 %, at 50/60 Hz
Influence of an adjacent conductor carrying an AC current	> 35 dB typical at 50/60 Hz
Safety	IEC/EN 61010-2-032 or BS EN 61010-2-032, pollution degree 2, 300 V CAT IV, 600 V CAT III
	

*Table 9*



**NOTE:** Currents < 0.1 A are set to zero.

f) MN193 clamp

MN193 clamp	
Nominal range	5 A and 100 Aac
Measurement range	5 mA to 6 A for the 5 A range 200 mA to 120 A for the 100 A range
Maximum clamping diameter	.78 in (20 mm)
Influence of the conductor's position in the clamp	< 0.5 %, at 50/60 Hz
Influence of an adjacent conductor carrying an AC current	> 35 dB typical at 50/60 Hz
Safety	IEC/EN 61010-2-032 or BS EN 61010-2-032, pollution degree 2, 300 V CAT IV, 600 V CAT III
	

Table 10

The 5 A range of MN193 clamp is suitable for measuring the secondary currents of current transformers.

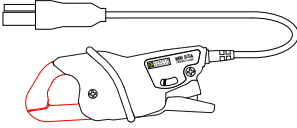

**NOTE:** Currents < 2.5 mA for the 5 A range and < 50 mA for the 100 A range are set to zero.

g) MN94 clamp

MN94 clamp	
Nominal range	200 Aac
Measurement range	50 mA to 200 A
Maximum clamping diameter	.62 in (16 mm)
Influence of the conductor's position in the clamp	< 0.08 %, at 50/60 Hz
Influence of an adjacent conductor carrying an AC current	> 45 dB typical at 50/60 Hz
Safety	IEC/EN 61010-2-032 or BS EN 61010-2-032, pollution degree 2, 300 V CAT IV, 600 V CAT III
	

Table 11



**NOTE:** Currents < 50 mA are set to zero.

#### h) Current sensor thresholds

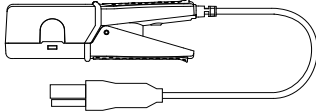
Sensor	Nominal current	Number of turns	Display threshold
SR193 clamp	1000 A		0.50 A
AmpFlex® 193 MiniFlex® MA193 or MA194	300 A	1 turn	0.40 A
		2 turns	0.21 A
		3 turns	0.15 A
	3000 A	1 turn	2 A
		2 turns	1 A
		3 turns	0.7 A
MN193 clamp	5 A		2.5 mA
	100 A		50 mA
MN93 clamp	200 A		0.1 A
MN94 clamp	200 A		50 mA

Table 12

#### 6.2.4.3 Intrinsic Uncertainty



**NOTE:** The intrinsic uncertainties of current and phase measurements must be added to the intrinsic uncertainties of the instrument for the quantity concerned: powers, energies, power factors, etc.

The following characteristics are given for the reference conditions of the current sensors.

#### Characteristics of current sensors with an output of 1 V at $I_{nom}$

I nominal	Current (RMS or DC)	Intrinsic uncertainty at 50/60 Hz	Intrinsic uncertainty on $\phi$ at 50/60 Hz	Typical uncertainty on $\phi$ at 50/60 Hz	Resolution
<b>SR193 clamp</b>					
1000 AAC	[1 A; 50 A]	$\pm 1 \% R$	-	-	10 mA
	[50 A; 100 A]	$\pm 0.5 \% R$	$\pm 1^\circ$	+ 0.25°	
	[100 A; 1200 A]	$\pm 0.3 \% R$	$\pm 0.7^\circ$	+ 0.2°	
<b>MN93 clamp</b>					
200 AAC	[0.5 A; 5 A]	$\pm 3 \% R \pm 1 A$	-	-	1 mA
	[5 A; 40 A]	$\pm 2.5 \% R \pm 1 A$	$\pm 5^\circ$	+ 2°	
	[40 A; 100 A]	$\pm 2 \% R \pm 1 A$	$\pm 3^\circ$	+ 1.2°	
	[100 A; 240 A]	$\pm 1 \% R \pm 1 A$	$\pm 2.5^\circ$	$\pm 0.8^\circ$	

I nominal	Current (RMS or DC)	Intrinsic uncertainty at 50/60 Hz	Intrinsic uncertainty on $\phi$ at 50/60 Hz	Typical uncertainty on $\phi$ at 50/60 Hz	Resolution
<b>MN193 clamp</b>					
100 AAC	[200 mA; 5 A]	$\pm 1\% R \pm 2 \text{ mA}$	$\pm 4^\circ$	-	1 mA
	[5 A; 120 A]	$\pm 1\% R$	$\pm 2.5^\circ$	+ 0.75°	
5 AAC	[5 mA; 250 mA]	$\pm 1.5\% R \pm 0.1 \text{ mA}$	-	-	1 mA
	[250 mA; 6 A]	$\pm 1\% R$	$\pm 5^\circ$	+ 1.7°	
<b>MN94 clamp</b>					
200 AAC	[0.05 A; 10 A]	$\pm 0.2\% R \pm 20 \text{ mA}$	$\pm 1^\circ$	$\pm 0.2^\circ$	1 mA
	[10 A; 240 A]		$\pm 0.2^\circ$	$\pm 0.1^\circ$	

Table 13

**AmpFlex® and MiniFlex® characteristics**

I nominal	Current (RMS or DC)	Intrinsic uncertainty at 50/60 Hz	Intrinsic uncertainty on $\phi$ at 50/60 Hz	Typical uncertainty on $\phi$ at 50/60 Hz	Resolution
<b>AmpFlex® 193</b>					
300 AAC	[0.5 A, 10 A]	$\pm 1.2\% R \pm 0.2 \text{ A}$	-	-	10 mA
	[10 A; 360 A]		$\pm 0.5^\circ$	0°	
3000 AAC	[1 A; 100 A]	$\pm 1.2\% R \pm 1 \text{ A}$	-	-	100 mA
	[100 A; 3600 A]		$\pm 0.5^\circ$	0°	
<b>MiniFlex® MA193</b>					
300 AAC	[0.5 A; 10 A]	$\pm 1\% R \pm 0.2 \text{ A}$	-	-	10 mA
	[10 A; 360 A]		$\pm 0.5^\circ$	0°	
<b>MiniFlex® MA194</b>					
3000 AAC	[1 A; 100 A]	$\pm 1\% R \pm 1 \text{ A}$	-	-	100 mA
	[100 A; 3600 A]		$\pm 0.5^\circ$	0°	

Table 14

**Crest factor:**

- (2.8 to 360) A on the 300 A range.
- (1.7 to 3600) A on the 3000 A range.

**AmpFlex® and MiniFlex® limitation**

Like all Rogowski sensors, the output voltage of AmpFlex® and MiniFlex® is proportionate to the frequency. High current at high frequency can saturate the current input of devices.

This requirement does not consider the bandwidth limitation of the device, which can lead to other errors.

## 6.3 VARIATION IN THE FIELD OF USE

### 6.3.1 General

**Internal clock drift:**  $\pm 5$  ppm/year at  $(77 \pm 5.4)$  °F  $(25 \pm 3)$  °C

### 6.3.2 Temperature

**V1, V2:** 27.78 ppm/°F (50 ppm/°C) typical

**I1, I2:** 83.33 ppm/°F (150 ppm/°C) typical, for  $5\% I_{nom} < I < 120\% I_{nom}$

**Internal clock:** 5.56 ppm/°F (10 ppm/°C)

### 6.3.3 Humidity

**Range of influence:** (30 to 75) % RH / 85 % RH at 73.4 °F (23 °C) excluding condensation

**V1, V2:**  $\pm 0.05\%$  typical

**I1, I2 ( $1\% I_{nom} \leq I \leq 10\% I_{nom}$ ):** 0.1 % typical

**( $10\% I_{nom} < I \leq 120\% I_{nom}$ ):** 0.05 % typical

### 6.3.4 Continuous Component

**Range of influence:**  $\pm 100$  VDC

**Quantities influenced:** V1, V2

**Rejection:**  $> 60$  dB

### 6.3.5 Frequency

**Range of influence:** (45 to 65) Hz,  $-60^\circ \leq \varphi \leq +60^\circ$

**Quantities influenced:** V1, V2, I1, I2, P1, P2

**Influence:** 0.1 %/Hz

### 6.3.6 Bandwidth

- Range of influence: 100 Hz to 5 kHz (harmonics)
- Presence of the fundamental at 50/60 Hz (THD = 50 %)
- V1, V2: 0.5 % @ 2.1 kHz / -3 dB @ 5 kHz
- I1, I2 (direct input): 0.5 % @ 1.75 kHz / -3 dB @ 5 kHz
- P1, P2: 0.5 % @ 1.25 kHz / -3 dB

### 6.3.7 Disturbed Signals

The following signal bandwidth is 6 kHz,  $5\% I_{nom} < I \leq 50\% I_{nom}$ .

Signal type	Sensor	Typical influence
Phase cut-off dimmer	MN193 clamp	< 1 %
	MiniFlex® MA194	< 3 %
Square	MN193 clamp	< 1 %
	MiniFlex® MA194	< 3 %

Table 15

Bridge rectifiers have a waveform that is not supported by the PEL 52.

## 6.4 POWER SUPPLY

### Power supply (between terminals V1 and N)

- **Operating range:** (100 to 600) V
  - DC voltage of 100 V or more will prevent the operation of the power supply.
- **Power:** (3 to 5) W depending on input voltage.
- **Current:**
  - at 100 VAC, 100 mA<sub>PEAK</sub> and 17 mA<sub>ARMS</sub>: Inrush current: 1.9 A<sub>PEAK</sub>
  - at 600 VAC, 500 mA<sub>PEAK</sub> and 0.026 mA<sub>ARMS</sub>: Inrush current: 5.3 A<sub>PEAK</sub>

### Battery

- (2) NiMH rechargeable elements type AAA 750 mA·h
  - **Lifespan:** at least 500 charge / discharge cycles or 2 years
  - **Charging time:** approx. 5 h
  - **Charging temperature:** (50 to 104) °F (10 to 40) °C
  - **Battery life with active Wi-Fi:** 1 hr min, 3 h typical



**NOTE:** When power is off, the real-time clock is retained for more than 20 days.



## 6.5 ENVIRONMENTAL CHARACTERISTICS

### ■ Temperature and Relative Humidity

Relative Humidity (%)

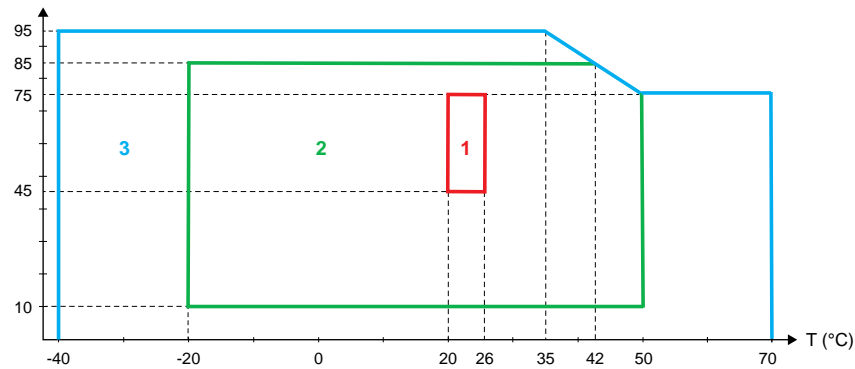

Figure 31

1 = Reference range

1 + 2 = Operating range

1 + 2 + 3 = Storage range with battery

### ■ For indoor use.

#### ■ Altitude

- Operating: (0 to 2000) m
- Storage: (0 to 10,000) m

## 6.6 Wi-Fi

- 2.4 G Hz IEEE 802.11 b/g band
  - Tx (b) power: +17.3 dBm
  - Tx (g) power: +14 dBm
  - Rx sensitivity: -98 dBm
  - Security: open / WPA2

## 6.7 MECHANICAL CHARACTERISTICS

- Dimensions: (7.09 x 3.46 x 1.46) in (180 x 88 x 37) mm
- Weight: Approx. 14.11 oz (400 g)
- Degree of protection (provided by the enclosure according to IEC 60529):
  - IP 54 when the device is not connected
  - IP 20 when the device is connected

## 6.8 ELECTRICAL SAFETY

The devices comply with IEC/EN 61010-2-030 or BS EN 61010-2-030 for a voltage of 600 V measurement CAT III, pollution degree 2.

The devices comply with BS EN 62749 for EMF. Product is intended for professional use only.

Battery load between terminals **V1** and **N**: 600 V surge CAT III, pollution degree 2.

The test leads and alligator clips comply with standard IEC/EN 61010-031 or BS EN 61010-031.

## 6.9 ELECTROMAGNETIC COMPATIBILITY

Emissions and immunity in industrial environment compatible with IEC/EN 61326-1 or BS EN 61326-1.

With the AmpFlex® and MiniFlex®, the typical influence on the measurement is 0.5 % of full scale with a maximum of 5 A.

## 6.10 RADIO EMISSION

The devices comply with the RED Directive 2014/53/EU and FCC regulations.

**FCC certification number for the Wi-Fi:** FCC QQQWF121

## 6.11 MEMORY CARD

Transferring a large amount of data from the SD card to a PC can take a long time. In addition, some computers can have difficulty processing such large amounts of information, and spreadsheets only accept a limited amount of data.

- To transfer data faster, use the SD/USB card adapter.
- Do not exceed 32 recordings on the SD card or the SD card may become full.
- The maximum size of a recording is 4 GB. The recording duration is unlimited (> 100 years).

---

## 7. MAINTENANCE

---



**NOTE:** Except for the batteries, the device does not contain any parts that can be replaced by untrained or unaccredited personnel. Any unauthorized work or part replacement with equivalents may seriously compromise safety.

---

### 7.1 CLEANING

---



**WARNING!** Risk of electric shock. Before cleaning, disconnect all inputs.

---

The instrument should be cleaned periodically to keep the LCD clear and prevent the buildup of dirt and grease around the instrument's buttons.

- Clean the body of the instrument with a damp and soapy cloth.
- Do not submerge the instrument in water.
- Do not use solvents.

#### **For current sensors:**

- Ensure that no foreign body interferes with the current sensor latching mechanism.
- Keep the air gaps of the clamp completely clean. Do not spray water directly on the clamps.

### 7.2 BATTERY

The device is equipped with a NiMH battery. This technology has several advantages:

- Long battery life for a limited volume and weight;
- Significantly reduced memory effect, which means you can charge the battery even if it is not completely discharged;
- Environmentally friendly with no polluting material, such as lead or cadmium, in accordance with applicable regulations.

The battery may be completely discharged after prolonged storage. If the battery is completely discharged, it must be fully charged. The device may not work during part of the charging. Charging a completely discharged battery may take several hours.



**NOTE:** If the battery is completely discharged, at least 5 charge/discharge cycles will be necessary for the battery to regain 95 % of capacity. Refer to the battery data sheet delivered with the device.

---

To optimize the use of your battery and extend the battery effective life:

- Charge the device only at temperatures between (50 and 104) °F (10 and 40) °C.
- Comply with the conditions for use.
- Comply with the conditions for storage.

### 7.3 UPDATING FIRMWARE

AEMC® Instruments strives to constantly improve our instruments and software. We offer firmware updates to keep your instrument updated and performing at the highest level possible.

- When your device is connected to the PEL Control Panel via Wi-Fi, you will be informed when a new firmware version is available.
- Start the update via the PEL Control Panel.



**NOTE:** Updating firmware may reset the configuration and cause loss of recorded data. As a precaution, back up the data in memory on a PC before updating the firmware.

---

### 7.4 REPAIR AND CALIBRATION

To ensure that your instrument meets factory specifications, we recommend that it be sent back to our factory Service Center at one-year intervals for recalibration or as required by other standards or internal procedures.

#### **For instrument repair and calibration:**

You must contact our Service Center for a Customer Service Authorization Number (CSA#). Send an email requesting a CSA#, you will be provided a CSA Form and other required paperwork along with the next steps to complete the request. Then return the instrument along with the signed CSA Form. This will ensure that when your instrument arrives, it will be tracked and processed promptly. Please write the CSA# on the outside of the shipping container. If the instrument is returned for calibration, we need to know if you want a standard calibration or a calibration traceable to N.I.S.T. (includes calibration certificate plus recorded calibration data).

#### **(Or contact your authorized distributor.)**

Contact us for the costs for repair, standard calibration, and calibration traceable to N.I.S.T.



**NOTE:** You must obtain a CSA# before returning any instrument.

---

## **7.6 LIMITED WARRANTY**

The instrument is warranted to the owner for a period of two years from the date of original purchase against defects in manufacture. This limited warranty is given by AEMC® Instruments, not by the distributor from whom it was purchased. This warranty is void if the unit has been tampered with, abused, or if the defect is related to service not performed by AEMC® Instruments.

**Please print the online Warranty Coverage Information for your records.**

### **What AEMC® Instruments will do:**

If a malfunction occurs within the warranty period, you may return the instrument to us for repair, provided we have your warranty registration information on file or a proof of purchase. AEMC® Instruments will repair or replace the faulty material at our discretion.

## 7.6.1 Warranty Repairs

### **What you must do to return an Instrument for Warranty Repair:**

First, send an email requesting a Customer Service Authorization Number (CSA#) from our Service Department. You will be provided a CSA Form and other required paperwork along with the next steps to complete the request. Then return the instrument along with the signed CSA Form. Please write the CSA# on the outside of the shipping container. Return the instrument, postage or shipment pre-paid

**Caution: To protect yourself against in-transit loss, we recommend that you insure your returned material.**



**NOTE: You must obtain a CSA# before returning any instrument.**

---

---

## 8. APPENDIX

---

### 8.1 MEASUREMENTS

#### 8.1.1 Definition

Geometric representation of active and reactive powers.

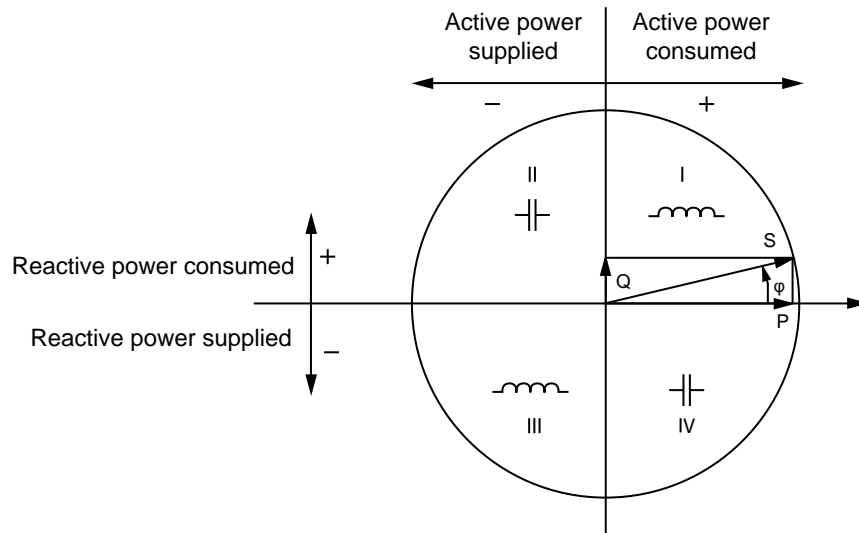

Figure 32

The reference of this diagram is the current vector (fixed on the right-hand part of the axis).

The voltage vector  $V$  varies in its direction as a function of the phase angle  $\phi$ .

The phase angle  $\phi$ , between voltage  $V$  and current  $I$ , is considered positive in the mathematical sense of the term (counterclockwise).

#### 8.1.2 Sampling

##### 8.1.2.1 “1 s” (one second) Quantities

The device calculates the following quantities every second on the basis of measurements over a cycle, according to § 8.2.

“1 s” quantities are used for:

- Real-time values.
- Trends over 1 second.
- Aggregation of values for “aggregated” trends .
- Determination of minimum and maximum values for the values of “aggregated” trends.

All “1 s” quantities can be recorded on the SD card during the recording session.

### 8.1.2.2 Aggregation

An aggregated quantity is a value calculated over a period defined according to the formulas indicated in Table 17.

The aggregation period always begins at the start of an hour or a minute. The aggregation period is the same for all quantities. The following periods are possible: 1, 2, 3, 4, 5, 6, 10, 12, 15, 20, 30, and 60 min.

All aggregated quantities are recorded on the SD card during the recording session. They can be displayed in the PEL Control Panel.

### 8.1.2.3 Minimum and Maximum

Min and Max are the minimum and maximum values of the “1 s” quantities for the aggregation period considered. They are recorded with their dates and times. The Max values of certain aggregated values are displayed directly on the device.

### 8.1.2.4 Calculation of Energies

Energies are calculated every second.

Total energies are available with the data of the recorded session.

## 8.2 MEASUREMENT FORMULAS

Quantities	Formulas	Comments
AC RMS phase-neutral voltage (VL)	$V_L[1s] = \sqrt{\frac{1}{N} \times \sum_1^N v_L^2}$	$v_L = v^1$ or $v^2$ incremental sample N = number of samples
AC RMS phase-phase voltage (UL)	$U_{ab}[1s] = \sqrt{\frac{1}{N} \times \sum_1^N u_{ab}^2}$	$ab = u_{12}$ incremental sample N = number of samples
AC RMS current (IL)	$I_L[1s] = \sqrt{\frac{1}{N} \times \sum_1^N i_L^2}$	$iL = i1, i2$ or $i3$ incremental sample N = number of samples
Active power (PL)	$P_L[1s] = \frac{1}{N} \times \sum_1^N (v_L \times i_L)$	L = I1 or I2 incremental sample N = number of samples $P_T[1s] = P_1[1s] + P_2[1s]$

Table 16



### 8.3 AGGREGATION

Aggregated quantities are calculated for a defined period according to the following formulas based on «1 s» values. Aggregation can be calculated by arithmetic average, quadratic average or other methods.

Quantities	Formula
Phase-neutral voltage ( $V_L$ ) (RMS)	$V_L[agg] = \sqrt{\frac{1}{N} \times \sum_{x=0}^{N-1} V_{Lx}^2[1s]}$
Phase-phase voltage ( $U_{ab}$ ) (RMS)	$U_{ab}[agg] = \sqrt{\frac{1}{N} \times \sum_{x=0}^{N-1} U_{abx}^2[1s]}$
Current ( $I_L$ ) (RMS)	$I_L[agg] = \sqrt{\frac{1}{N} \times \sum_{x=0}^{N-1} I_{Lx}^2[1s]}$
Frequency ( $F_L$ )	$F[agg] = \frac{1}{N} \times \sum_{x=0}^{N-1} F_x[1s]$
Active power ( $P_L$ )	$P_L[agg] = \frac{1}{N} \times \sum_{x=0}^{N-1} P_{Lx}[1s]$
Reactive power ( $Q_L$ )	$Q_L[agg] = \frac{1}{N} \times \sum_{x=0}^{N-1} Q_{Lx}[1s]$
Apparent power ( $S_L$ )	$S_L[agg] = \frac{1}{N} \times \sum_{x=0}^{N-1} S_{Lx}[1s]$
Source power factor with the associated quadrant ( $PF_{SL}$ )	$PF_{SL}[agg] = \frac{1}{N} \times \sum_{x=0}^{N-1} PF_{SLx}[1s]$
Load power factor with the associated quadrant ( $PF_{LL}$ )	$PF_{LL}[agg] = \frac{1}{N} \times \sum_{x=0}^{N-1} PF_{LLx}[1s]$
Cos ( $\varphi$ ) <sub>s</sub> of the source with the associated quadrant	$\text{Cos}(\varphi_L)_s[agg] = \frac{1}{N} \times \sum_{x=0}^{N-1} \text{Cos}(\varphi_L)_s[1s]$
Cos ( $\varphi$ ) <sub>L</sub> of the load with the associated quadrant	$\text{Cos}(\varphi_L)_L[agg] = \frac{1}{N} \times \sum_{x=0}^{N-1} \text{Cos}(\varphi_L)_L[1s]$

Table 17

N is the number of “1 s” values for the aggregation period considered (1, 2, 3, 4, 5, 6, 10, 12, 15, 20, 30, or 60 minutes).

## 8.4 SUPPORTED ELECTRICAL NETWORKS

The following types of distribution networks are supported:

- Single phase (single phase 2-wire 1 current)
- Single phase (single phase 3-wire 2 currents)
- Two-phase (split-phase single phase 3-wire)
  - V1, V2 are the phase-neutral voltages of the installation measured. [V1=VL1-N; V2=VL2-N].
  - The lower case letters v1, v2, v3 denote the sampled values.
  - U12 is the voltage between phases of the installation measured.
  - Lower case letters denote the sampled values [u12 = v1-v2].
  - I1, I2 are the currents flowing in the phase conductors of the installation measured.
  - The lower case letters i1, i2, i3 denote the sampled values.

Single phase (single phase 2-wire 1 current)		
Abbreviation	Comments	Reference diagram
1P- 2W1I	Voltage is measured between L1 and N. Current is measured on conductor L1.	see § 4.1.1

Single phase (single phase 3-wire 2 currents)		
Abbreviation	Comments	Reference diagram
1P- 3W2I	Voltage is measured between L1 and N. Current is measured on conductors L1 and L2.	see § 4.1.2

  

Two-phase (split-phase single phase 3-wire)		
Abbreviation	Comments	Reference diagram
2P-3W2I	Voltage is measured between L1, L2, and N. Current is measured on conductors L1 and L2.	see § 4.1.3

Table 18

## 8.5 VALUES AVAILABLE

●	available on the instrument and in the PEL Control Panel
○	available in the PEL Control Panel
□	not available

Quantities	Symbol	Real-time value 1 s	Trend value 1 s	Max value 	Trend value aggregated	Min/Max 1 s aggregated
Phase-neutral voltage	$V_1, V_2$	●	○	●	○	○
Phase-phase voltage	$U_{12}$	●	○	●	○	○
Current	$I_1, I_2$	●	○	●	○	○
Frequency	$f$	●	○		○	○
Active power	$P_1, P_2, P_T$	●	○		○	
Active power on the source	$P_1, P_2, P_T$			●	○	○ <sup>(1)</sup>
Active power on the load	$P_1, P_2, P_T$			●	○	○ <sup>(1)</sup>
Fundamental active power	$Pf_1, Pf_2, Pf_T$	○	○		○	
Fundamental active power on the source	$Pf_1, Pf_2, Pf_T$				○	
Fundamental active power on the load	$Pf_1, Pf_2, Pf_T$				○	
Reactive power	$Q_1, Q_2, Q_T$	●	○		○	
Reactive power on the source	$Q_1, Q_2, Q_T$			●	○	○ <sup>(1)</sup>
Reactive power on the load	$Q_1, Q_2, Q_T$			●	○	○ <sup>(1)</sup>
Apparent power	$S_1, S_2, S_T$	●	○		○	○ <sup>(1)</sup>
Apparent power on the source	$S_1, S_2, S_T$			●	○	
Apparent power on the load	$S_1, S_2, S_T$			●	○	
Non-active power	$N_1, N_2, N_T$	○	○		○	

Quantities	Symbol	Real-time value 1 s	Trend value 1 s	Max value 	Trend value aggregated	Min/Max 1 s aggregated
Distorting power	$D_1, D_2, D_T$	○	○		○	
Power factor	$PF_1,$ $PF_2,$ $PF_T$	●	○			
Power factor on the source	$PF_1,$ $PF_2,$ $PF_T$				○	
Power factor on the load	$PF_1,$ $PF_2,$ $PF_T$				○	
Cos $\varphi$	$\text{Cos } \varphi_1,$ $\text{Cos } \varphi_2,$ $\text{Cos } \varphi_T$	○	○			
Cos $\varphi$ on the source	$\text{Cos } \varphi_1,$ $\text{Cos } \varphi_2,$ $\text{Cos } \varphi_T$				○	
Cos $\varphi$ on the load	$\text{Cos } \varphi_1,$ $\text{Cos } \varphi_2,$ $\text{Cos } \varphi_T$				○	
Total active energy on the source	$E_{p_T}$	●	○			
Total active energy on the load	$E_{p_T}$	●	○			
Reactive energy on quadrant 1	$E_{q_T}$	●	○			
Reactive energy on quadrant 2	$E_{q_T}$	●	○			
Reactive energy on quadrant 3	$E_{q_T}$	●	○			
Reactive energy on quadrant 4	$E_{q_T}$	●	○			
Apparent energy on the source	$E_{s_T}$	●	○			
Apparent energy on the load	$E_{s_T}$	●	○			
$\Phi (I_1, I_2)$		●				
$\Phi (V_1, V_2)$		●				

Quantities	Symbol	Real-time value 1 s	Trend value 1 s	Max value 	Trend value aggregated	Min/Max 1 s aggregated
$\Phi (I_1, V_1)$		•				
$\Phi (I_2, V_2)$		•				

Table 19

(1) No minimum value for  $P_1, P_2, P_T, Q_1, Q_2, Q_T$

## 8.6 GLOSSARY

### Prefixes of units of the International System (SI):

Prefix	Symbol	Multiplied by
milli	m	$10^{-3}$
kilo	k	$10^3$
Mega	M	$10^6$
Giga	G	$10^9$
Tera	T	$10^{12}$
Peta	P	$10^{15}$
Exa	E	$10^{18}$

Table 20

$\phi$	Phase offset of the voltage relative to the current
°	Degree
%	Percentage
A	Ampere (current unit)
AC	AC component (current or voltage)
Aggregation	Different averages defined at § 9.3
CF	Current or voltage peak factor: ratio of the peak value of a signal to the effective value
$\cos \phi$	Cosine of the phase shift of the voltage with respect to the current
DC	DC component (current or voltage)
DataViewSync™	Internet Relay system that relays data between the recorder and a PC
Ep	Active energy
Eq	Reactive energy

<b>Es</b>	Apparent energy
<b>Frequency</b>	Number of full cycles of voltage or current per second
<b>Hz</b>	Hertz (unit of frequency)
<b>I</b>	Symbol for current
<b>L</b>	Phase of a multiphase network
<b>MAX</b>	Maximum value
<b>MIN</b>	Minimum value
<b>P</b>	Active power
<b>PF</b>	Power Factor: Ratio of active power to apparent power
<b>Q</b>	Reactive power
<b>RMS</b>	RMS (Root Mean Square) average quadratic value of the current or voltage. Square root of the average of the squares of instantaneous values of a quantity during a specified interval
<b>S</b>	Apparent power
<b>Nominal voltage</b>	Nominal voltage of a network
<b>U</b>	Voltage between two phases
<b>V</b>	Phase-neutral voltage or Volt (unit of voltage)
<b>VA</b>	Unit of apparent power (Volt x Ampere)
<b>var</b>	Unit of reactive power
<b>varh</b>	Unit of reactive energy
<b>W</b>	Unit of active power (Watt).
<b>W·h</b>	Unit of active energy (Watt x hours)