

**Pressure Module (PM)**

**ACCURACY**

**bar (Gauge Pressure)**

**3, 10, and 30 bar modules**

0 to 30% of Range:  $\pm (0.0075\% \text{ of Full Scale})$

30 to 110% of Range:  $\pm (0.025\% \text{ of Reading})$

Vacuum: For 3 and 10 bar

$\pm (0.06\% \text{ of Full Scale}^*)$

For 30 bar

$\pm (0.06\% \text{ of Full Scale}^*) \pm 1 \text{ LSD}$

\* Full Scale = -1.0 bar

**100, 300, 700, and 1000 bar**

0 to 30% of Range:  $\pm (0.015\% \text{ of Full Scale})$

30 to 110% of Range:  $\pm (0.05\% \text{ of Reading})$

*Includes all effects of linearity, hysteresis, repeatability, temperature, and stability for one year.*

*All models indicate vacuum, but vacuum specification applies to 3, 10, and 30 bar models only.*

*Not recommended for continuous use at high vacuum.*

*Refer to [XP2i-DP data sheet](#) for gauges that are intended for continuous high vacuum use.*

**barA (Pressure with BARO module)**

**3 bar module**

0.0138 to 1.0000 barA:  $\pm 0.0008 \text{ barA}$

1.0000 to 4.0000 barA:  $\pm (0.025\% \text{ of Reading})$   
 $+ 0.0003 \text{ barA}$

**10 bar module**

0.0138 to 1.0000 barA:  $\pm 0.0008 \text{ barA}$

1.0000 to 4.0000 barA:  $\pm 0.0010 \text{ barA}$   
4.0000 to 11.0000 barA:  $\pm (0.025\% \text{ of Reading})$

**30 bar module**

0.014 to 1.000 barA:  $\pm 0.001 \text{ barA}$

1.000 to 10.000 barA:  $\pm 0.003 \text{ barA}$   
10.000 to 31.000 barA:  $\pm (0.025\% \text{ of Reading})$

**100 bar module**

1.000 to 31.000 barA:  $\pm 0.015 \text{ barA}$

31.000 to 101.000 barA:  $\pm (0.05\% \text{ of Reading})$

**300 bar module**

1.00 to 91.00 barA:  $\pm 0.05 \text{ barA}$

91.00 to 301.00 barA:  $\pm (0.05\% \text{ of Reading})$

**700 bar module**

1.00 to 211.00 barA:  $\pm 0.11 \text{ barA}$

211.00 to 701.00 barA:  $\pm (0.05\% \text{ of Reading})$

**1000 bar module**

1.00 to 301.00 barA:  $\pm 0.15 \text{ barA}$

301.00 to 1001.00 barA:  $\pm (0.05\% \text{ of Reading})$

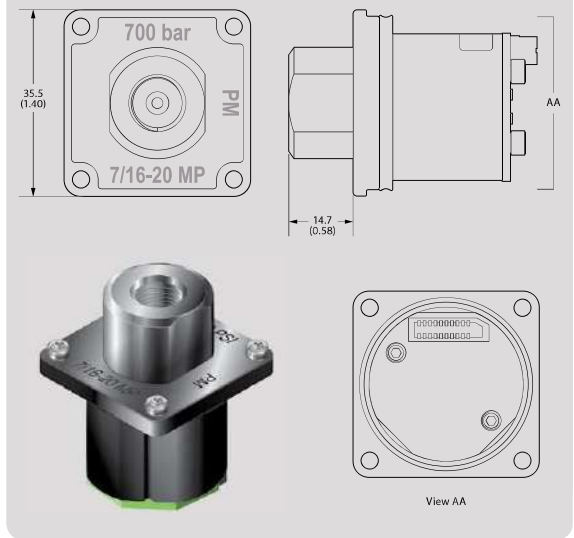

**DIFFERENTIAL PRESSURE MEASUREMENT UNCERTAINTIES WITH TARE**

The Tare function can improve measurement uncertainties on two modules with the same full scale pressure range installed into one nVision Reference Recorder. Requires the use of an equalizing valve.

The following specifications apply to the measurement system with a logging interval of 1 second/reading:

Full Scale Range of Both Sensors	The Greater of (+/-)				or	% of DP Reading
	mbar	psi	inH <sub>2</sub> O	mmH <sub>2</sub> O		
3	0.04	0.0005	0.014	0.4	or	0.025%
10	0.10	0.0015	0.04	1.0	or	0.025%
30	0.4	0.005	0.14	4.0	or	0.025%
100	1.0	0.02	0.4	10.0	or	0.05%
300	4.0	0.05	1.4	n/a	or	0.05%
700	10.0	0.2	4.0	n/a	or	0.05%
1000	15.0	0.3	6.0	n/a	or	0.05%

Unit must be enabled in CrystalControl

**DIFFERENTIAL PRESSURE MEASUREMENT UNCERTAINTIES WITHOUT TARE**

The total nVision Reference Calibrator measurement uncertainty in the  $\Delta P$  mode configuration will need to consider the uncertainties of both pressure modules. We recommend the module uncertainties to be combined with the preferred square root of the sum of the squares (or "root sum squares") method.

The following table lists the possible combinations of using Pressure Modules (PM) with different accuracy statements. The uncertainties reported below are without the use of the Tare feature, which will greatly improve your measurement uncertainty.

Lower Pressure Module Uncertainties (of Static Line Pressure) (of Reading)	Upper Pressure Module Uncertainties (of Static Line Pressure) (of Reading)		
	0.025%	0.025%	0.05%
0.025%	0.035%	0.056%	0.056%
0.05%	0.056%	0.071%	0.071%

**SENSOR**

Wetted Materials: (WRENCH TIGHT) **316 stainless steel**  
 (FINGER TIGHT) **316 stainless steel**  
**and Viton® (internal o-ring)**

Diaphragm Seal Fluid: **Silicone Oil**

Connection: **Crystal CPF\* Female**

*All welded, with a permanently filled diaphragm seal.*  
*Metal to metal cone seal; O-ring can be removed if necessary.*  
*1/4" medium pressure tube system compatible with HIP LM4 and LF4 Series, Autoclave Engr SF250CX Male and Female Series.*  
*CPF Adapters to NPT, BSP, and M20 available.*  
 \*U.S. Patent No. 8,794,677

**BAROMETRIC REFERENCE (BARO)**

Accuracy: **± 0.5 mbar, ± 0.00725 psi**

Range: **700.0 to 1100.0 mbarA,**  
**10.153 to 15.954 psiA**

Units and Resolution: **psi** ..... **0.001**  
**inHg** ..... **0.001**  
**mmHg** ..... **0.01**  
**mbar** ..... **0.1**

Pressure Connection: **Cylindrical sensor fitting of 5.8mm OD. A flexible 4.8 mm [3/16"] ID tube is recommended to connect for calibration.**

Mounting: **Secured using a 3/8" 4-40 plastic screw.**

*Includes all effects of linearity, hysteresis, repeatability, temperature, and stability for one year.*  
*Exposure to environmental extremes of temperature, shock, and/or vibration may warrant a more frequent recertification period.*  
*Other units available depending on the installed modules.*  
**Plastic non-conductive screw must be used to comply with hazardous location requirements.**



**Current, Voltage, & Switch Test Module (MA20)**

Intended for use with a 4-20mA loop measurement. This module is also capable of measuring supply voltages and has an auxiliary fixed output for use in switch open/closure testing. Each MA20 module includes a super flexible silicone test lead kit (P/N 3952).

**CURRENT & VOLTAGE MEASUREMENT**

**Current (mA) Input**

Accuracy:  $\pm (0.015\% \text{ of rdg} + 0.002 \text{ mA})$

Range: **0 to 55 mA (MA20)**

Max Allowable Current: **93.3 mA**

Resolution: **0.001 mA or 0.01%**

Units: **mA, % 4-20, % 10-50**

Input Resistance: **< 17.2  $\Omega$**

Voltage Burden @ 20mA: **< 0.35 V**

Voltage Burden @ 50mA: **< 0.86 V**

HART Resistance: **250  $\Omega$**

Connection: **2mm jacks**

*Includes all effects of linearity, hysteresis, repeatability, temperature, and stability for one year.*

*For hazardous location product warnings, refer to the operation manual.*

*Inputs protected by a resettable fuse.*

*mA can be displayed as a percentage, where 0 to 100% corresponds to either 4 to 20 mA or 10 to 50 mA.*

*Jacks are compatible with safety sheathed banana plugs.*

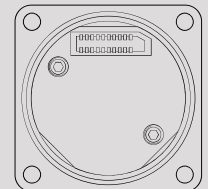
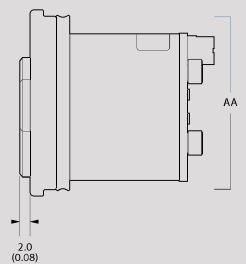
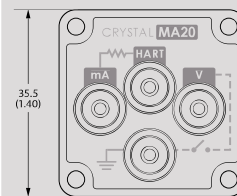

View AA

**Voltage (VDC) Input**

Accuracy:  $\pm (0.015\% \text{ of rdg} + 0.002 \text{ VDC})$

Range: **0 to 28 VDC**

Max Allowable Voltage: **30 VDC**

Resolution: **0.001 VDC**

Units: **VDC**

*Includes all effects of linearity, hysteresis, repeatability, temperature, and stability for one year.*

**Switch Test**

Switch Type: **Dry Contact**

Closed State Resistance: **< 10  $\Omega$**

Open State Resistance: **> 10 M $\Omega$**

*Switch state change indicated by bright green LED flash.*

*Switch test screen reports switch open, close, and deadband values.*



**ATEX and IECEx Scheme Entity Parameters**

The MA20 Module has these specific input entity parameters:

- Ui = 28 V**
- li = 93.3 mA**
- Pi = 653.3 mW**
- Ci = 0.36  $\mu$ F**
- Li = 39.1  $\mu$ H**
- Uo = 6.6 V**
- Io = 4.45 mA**
- Po = 7.34 mW**
- Co = 0.5  $\mu$ F\***
- Lo = 12  $\mu$ H\*\***

\* Dependent on the supply to the terminals but shall not be greater than 0.5  $\mu$ F  
 \*\* Total cable inductance between all modules

**Temperature Module (RTD100)**

Calibrated for Pt100 RTD/PRT (100 Ohms at 0°C Platinum Resistance Temperature Detector) sensors conforming to DIN/IEC 60751 (or IEC751) with US, Euro, or Lab calibration curves. An RTD is not included, but each RTD100 includes P/N 3953 RTD Connection Kit.

**TEMPERATURE MEASUREMENT**

**Resistance Input**

Accuracy:  $\pm (0.015\% \text{ of rdg} + 0.02 \Omega)$

Range: **0 – 400 Ohms range for use with 100 Ohm PRTs**

Resolution: **0.01 on all scales**

Units:  $^{\circ}\text{C}$ ,  $\text{K}$ ,  $^{\circ}\text{F}$ ,  $\text{R}$ ,  $\Omega$

TCRs: **0.003850  $\Omega/\Omega/^{\circ}\text{C}$  (IEC 60751), 0.003911  $\Omega/\Omega/^{\circ}\text{C}$  (US Industrial Std), 0.003926  $\Omega/\Omega/^{\circ}\text{C}$**

Wiring: **2-, 3-, 4-wire support**

Connection: **M8 connector cable or terminal block**

*Includes all effects of linearity, hysteresis, repeatability, temperature, and stability for one year.*

The proper selection of the RTD sensing element is very important as the error associated with this device is the majority of the overall system measurement uncertainty. IEC 751 is the standard that defines the temperature versus resistance for 100 $\Omega$ , 0.00385  $\Omega/\Omega/^{\circ}\text{C}$  platinum RTDs. IEC 751 defines two classes of RTDs: Class A and B. Class A RTDs operate over the -200 to 630 $^{\circ}\text{C}$  range versus -200 to 800 $^{\circ}\text{C}$  for the Class B elements. For example, the Class A uncertainty is about half that of the Class B elements as illustrated in the following table.

Temperature $^{\circ}\text{C}$	nVision Uncertainty		Class A				Class B			
			Class A Uncertainty		nVision + Class A Uncertainty		Class B Uncertainty		nVision + Class B Uncertainty	
	$\pm\Omega$	$\pm^{\circ}\text{C}$	$\pm\Omega$	$\pm^{\circ}\text{C}$	$\pm\Omega$	$\pm^{\circ}\text{C}$	$\pm\Omega$	$\pm^{\circ}\text{C}$	$\pm\Omega$	$\pm^{\circ}\text{C}$
-200	0.02	0.05	0.24	0.55	0.24	0.55	0.56	1.30	0.56	1.30
0	0.04	0.09	0.06	0.15	0.07	0.17	0.12	0.30	0.12	0.31
200	0.05	0.13	0.2	0.55	0.21	0.56	0.48	1.30	0.48	1.31
400	0.06	0.17	0.33	0.95	0.33	0.96	0.79	2.30	0.79	2.31
600	0.07	0.21	0.43	1.35	0.44	1.37	1.06	3.30	1.06	3.31
800	0.08	0.25	0.52	1.75	0.53	1.77	1.28	4.30	1.28	4.31

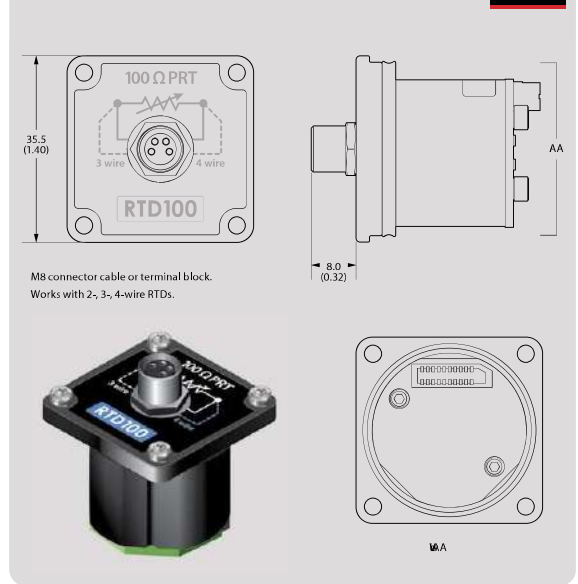

M8 connector cable or terminal block. Works with 2-, 3-, 4-wire RTDs.

**ATEX IEC IECEx ATEX and IECEx Scheme Entity Parameters**

The RTD100 Module has these specific input entity parameters:

- Ui = 0 V**
- Ii = 0 A**
- Pi = 0 W**
- Uo = 9.73 V**
- Io = 1.6642 A**
- Po = 1.1 W**
- Co = 0.5 uF**
- Lo = 12 uH\***

\* Total cable inductance between all modules

**nVision Chassis (NV)**

**OPERATING TEMPERATURE**

Temperature Range: **-20 to 50° C (-4 to 122° F)**

< 95% RH, non-condensing. No change in accuracy over operating temperature range. Gauge must be zeroed to achieve rated specification.

Applies to all modules.

**DISPLAY**

Screen: **255 x 160 pixel graphical display**

LCD readable in sunlight with bright backlight.

Display Rate: **4 readings/second (standard)**

**up to 10 readings/second (recording)**

**POWER**

The nVision is Intrinsically Safe only if powered by one of the following battery types.

ATEX/IECEX:	Approved Battery Type	Ta=	Marking
	Rayovac Max Plus 815	-20 to 50° C	Ex ia IIB T4 Ga
	Duracell MN1500	-20 to 45° C	
	Energizer E91, EN91	-20 to 50° C	Ex ia IIB T3 Ga
	Duracell MN1500		

CSA:	Approved Battery Type	Ta=	Marking
	Rayovac Max Plus 815	-20 to 50° C	Class I, Division 1, Grp C, D T4
	Duracell MN1500	-20 to 45° C	
	Energizer E91	-20 to 50° C	Class I, Division 1, Grp C, D T3B
	Energizer EN91		Class I, Division 1, Grp C, D T3A
	Duracell MN1500		Class I, Division 1, Grp C, D T3C

4 x AA: **200 hours, typical**

Ultra Low Power: **Up to 60 days, typical\***

\*2 installed modules, 1 reading per 5 minute recording interval, and 23° C ambient temperature.

Uses 4 alkaline AA (LR6) batteries. Use of backlight reduces operating time.

For hazardous location product warnings, refer to the operation manual.

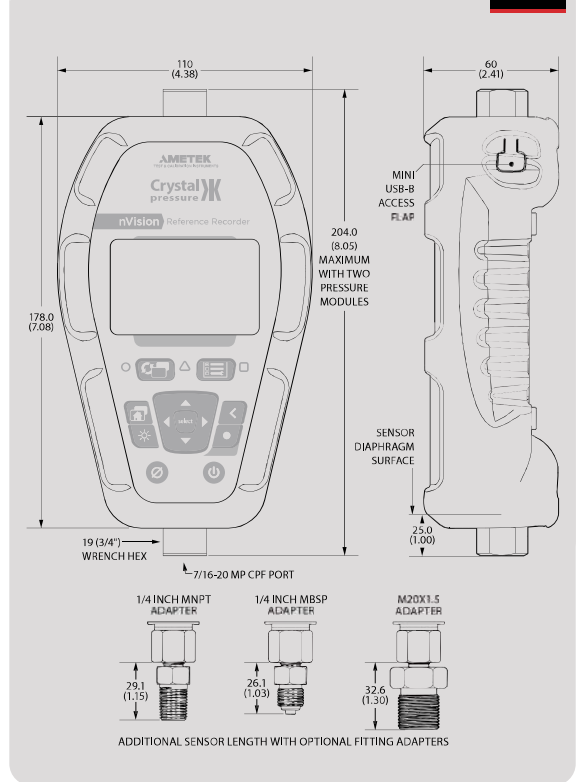

**DATA/COMMUNICATION**

Digital Interface: **mini-USB**

*The mini USB will power the nVision with or without the battery pack installed.*

*For hazardous location product warnings, refer to the operation manual.*

**DATALOGGING**

Capacity: **Approx. 1,000,000 data points\***

*\*Single Module Recording*

Storage Type: **Non-volatile flash memory**

*Limit of 64 individual recordings.*

Fastest Interval: **10 per second**

*The included CrystalControl software is compatible with Vista (SP 2), Windows 7 (SP 1), Windows 8.1 and Windows 10.*

Slowest Interval: **1 per hour**

*Produces csv, xls, pdf, or signed pdf files, and uses Excel template files (samples included) to automatically format and graph data.*

**ENCLOSURE**

Weight: **680 g (24.0 oz)**

*Weight includes one pressure module, one RTD module, 4AA battery module, and protective boot.*

Rating: **IP66 and IP67**

*Submersible to 1 m for 30 minutes (IEC 60529).*

Housing: **Impact resistant injection molded**

*LCD protected from impact damage by 1.5 mm (0.06") thick polycarbonate lens.*

Keypad and Labels: **UV Resistant Polyester**

Mounting: **M4 x 0.7 [8 mm (0.31")] deep threaded insert mounting locations**

*Skydrol® compatible.*

*For hazardous location product warnings, refer to the operation manual.*

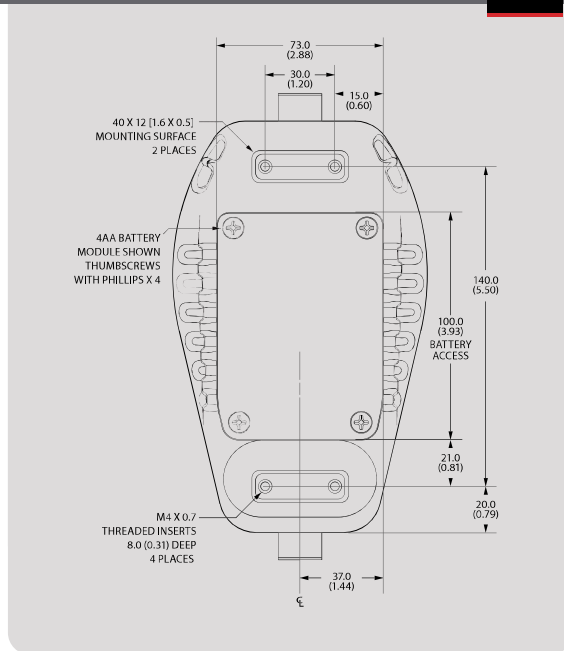

### STORAGE TEMPERATURE

Temperature Range: **-40 to 75° C (-40 to 167° F)**

*Batteries should be removed if stored for more than one month.*

### SPECIAL FEATURES

The following requires the use of our free [CrystalControl](#) software

Averaging Screen: **Averages all points in a recording run.**

Data Point Counter: **Screen for counting the data points logged.**

Display Screens: **Turn on and rearrange display screens.**

Estimated Recording Time: **A CrystalControl calculation based on active screens and logging interval.**

Live PC Graph: **During a recording, graph directly to your PC.**

Password Protect: **Changes to configuration or userspan calibration factor(s).**

Pressure Switch Test: **Using a PM and MA20, get deadband and state-change pressure.**

Remove: **Unwanted pressure units.**

Run Tags: **Create and enable run tags that will identify logging runs.**

Screen Numbers: **Number each display screen to make writing procedures around the nVision easier.**

Secure Documents: **Download into secure pdf documents for tamper proof records.**

Start-up Screen: **Define a 32-character prompt which requires user acknowledgement at startup.**

User Defined Unit: **Define and display any pressure units not included, or to use the gauge to display force, level or other pressure related parameters.**

### STANDARD DELIVERY

- nVision Recorder
- CD Manual
- ISO 17025 Accredited Calibration Certificate, NIST Traceable
- Soft Carrying Case **P/N 6053**
- Protective Boot **P/N 3985**
- Mini-USB Cable **P/N 3951**

### COMPLEMENTARY PRODUCTS

Crystal Engineering offers a wide range of products that work with the nVision:

- [Fittings that connect without tools, safely and without leaks](#)
- [Lightweight, super flexible high pressure hoses](#)
- [Fitting kits and adapters](#)
- [Pneumatic hand pumps](#)
- [Hydraulic hand pumps](#)
- [Portable pressure comparators](#)
- [Software, for the quickest way to calibrate pressure transmitters and gauges](#)

### CERTIFICATIONS



**II 1G Ex ia IIB T4 Ga or T3  
SIRA 09 ATEX 2008X**



**Ex ia IIB T4 Ga or T3  
IECEx SIR 09.0053X**



Exia Intrinsically Safe and Non-incendive for Hazardous Locations: Class I, Division 1, Groups C and D, Temperature Code T4/T3A/TCB/T3C. For hazardous location product warnings, refer to the operation manual.



nVision complies with the Electromagnetic Compatibility and the Pressure Equipment Directives.



nVision complies with the Australian Radiocommunications (Electromagnetic Compatibility) Standard 2008.



nVision is approved for use as a portable test instrument for Marine use and complies with Det Norske Veritas' Rules for Classification of Ships, High Speed & Light Craft and Offshore Standards.

### ACCESSORIES

**BARO Calibration Kit P/N 4547**

**Magnetic Hanging Strap P/N 5177**

**Waterproof Carrying Case P/N 2888**

**RTD Terminal Block P/N 3953 (included with RTD100 module)**

**Test Lead Kit P/N 3952 (included with MA20 Module)**



**RANGE & RESOLUTION TABLE**

PM	Range (bar)	Over-pressure	Display Resolution									
			bar	mbar	kPa	MPa	psi	in H <sub>2</sub> O	in Hg	mm Hg	mm H <sub>2</sub> O	kg/cm <sup>2</sup>
3BAR	3	3.0 x	0.0001	0.1	0.01		0.001	0.01	0.001	0.01	1	0.0001
10BAR	10	2.0 x	0.0001	0.1	0.01	0.00001	0.001	0.1	0.01	0.1	1	0.0001
30BAR	30	2.0 x	0.001	1	0.1	0.0001	0.01	0.1	0.01	0.1		0.001
100BAR	100	2.0 x	0.001		0.1	0.0001	0.1		0.1			0.001
300BAR	300	1.5 x	0.01		1	0.001	0.1		0.1			0.01
700BAR	700	1.5 x	0.01		1	0.001	1					0.01
1KBAR	1000	1.3 x	0.01		1	0.001	1					0.01

(Add one digit of resolution for differential mode.)

**ORDERING INFORMATION** (BAR versions available in USA direct from factory only.)

Model	Power	Upper Module	Lower Module	BARO Module	Pump System*	Carrying Case~
NV	4AA					
	Pressure:	PM	PM	No ... (omit)	No Pump... (omit)	
	Current, Voltage, and Switch:	MA20	MA20	Yes... -BARO	System A... -AXX	Aluminum ... (omit)
	Temperature:	RTD100‡	RTD100‡		System A... -AHX	Waterproof... -W
	Blank Plate:	BNKPLT	BNKPLT		System B... -BXX	
					System B... -BHX	
					System C... -CXX	
					System C... -CHX	
					System D... -DOX	
					System D... -DWX	
					System E... -EOX	
					System F... -FOV	
					System F... -FWV	
					System G... -GOX	
					System G... -GWX	
					System H... -HOX	

If ordering an nVision with only one module installed, enter **BNKPLT** in the empty module slot.

**SAMPLE PART NUMBERS**

NV-4AA-3BAR-300BAR-BAR0... nVision with 3 bar pressure module (upper) and 300 bar pressure module (lower); and a BARO module option.

NV-4AA-RTD100‡-700BAR-GWX-W nVision with RTD100 temperature module (upper) and 700 bar pressure module (lower); a System G pump system; and a waterproof carrying case.

‡ RTD100 does not include a temperature probe. Please choose a probe from the list below, or from a more comprehensive list on our website under **Accessories**. Alternatively, connect to your own probes with the supplied RTD100 mating connector.

Part #	Description
4126	RTD100/385, 3 wire, class B, 4" x.188" probe with 48 inch cable
4623-1	RTD100/385, 3 wire, class B, 4" x.188" probe with 13 foot cable
4623-3	RTD100/385, 3 wire, class B, 4" x.188" probe with 20 foot cable
4623-6	RTD100/385, 4 wire, class A3, 4" x .250" probe with 100 foot cable

AMETEK offers a variety of solutions for pressure generation and measurement. Our line of products for pressure generation includes everything from small pneumatic hand pumps to a precision, hydraulic pressure comparator capable of generating up to 15 000 psi / 1000 bar / 100 MPa.

All of our pumps may be ordered as part of a Pump System, complete with an nVision and delivered in a sturdy carrying case with custom insert.

\* Refer to the following page for a more detailed description of each pump system.

~ The Waterproof Case is an option for Systems A, B, and C only.  
The Waterproof Case is the only option for Systems G and H.















**Ordering a Pump System Only**

Any pump system, carrying case, and connection fittings for an nVision reference recorder may be ordered separately from the gauge. Enter NV-NONE followed by the Pump System part number and the Carrying Case option code.

**SAMPLE PART NUMBERS**

NV-NONE-GWX-W... System G pump system with a waterproof carrying case.

**PUMP SYSTEMS OVERVIEW**

Pump System	Part Number	Pressure Range	Pneumatic	Hydraulic	Hand Pump	Bench Top	Included Pump	Case Options	
								Aluminum	Waterproof (Pelican Case)
System A	AXX	0 to 30psi /2 bar	■		■		 T-960-CPF	■	■
	AHX	0 to 580 psi /40 bar	■		■		 T-970-CPF	■	■
System B	BXX	-25 inHg to 30 psi /-0.85 to 2 bar	■		■		 T-965-CPF	■	■
	BHX	-27 inHg to 580 psi /-0.91 to 40 bar	■		■		 T-975-CPF	■	■
System C	CXX	0 to 3000 psi /200 bar		■ (Oil)	■		 T-620-CPF	■	■
	CHX	0 to 5000 psi /350 bar		■ (Oil)	■		 T-620H-CPF	■	■
System D	DOX	0 to 5000 psi /350 bar		■ (Oil)		■	 P-018-CPF	■	
	DWX	0 to 5000 psi /350 bar		■ (Water)		■	 P-014-CPF	■	
System E	EOX	0 to 10 000 psi /700 bar		■ (Oil)		■	 T-1-CPF	■	
System F	FOV	0 to 15 000 psi /1000 bar		■ (Oil)		■	 GaugeCalHP	■	■
	FWV	0 to 15 000 psi /1000 bar		■ (Water)		■	 T-975-CPF	■	■
System G	GOX	0 to 15 000 psi /1000 bar		■ (Oil)		■	 T-620H-CPF		■
	GWX	0 to 15 000 psi /1000 bar		■ (Water)		■	 T-975-CPF		■
System H	HOX	-27 inHg to 580 psi /-0.91 to 40 bar	■		■		 T-975-CPF		■
		0 to 5000 psi /350 bar		■ (Oil)	■		 T-620H-CPF		■