

Leica Detection DD Series Locators & Accessories



User Manual
Version 1.0
English

- when it has to be **right**

Leica
Geosystems

1.800.561.8187

www.**itm**.com

information@itm.com

Introduction

Purchase

Congratulations on the purchase of a Leica Detection product.



This manual contains important safety directions as well as instructions for setting up the product and operating it. Refer to "1 Safety Directions" for further information.

Read carefully through the User Manual before you switch on the product.

Product identification

The model and serial number of your product are indicated on the type plate. Always refer to this information when you need to contact your agency or Leica Geosystems authorised service centre.



Trademarks

- *Bluetooth®* is a registered trademark of Bluetooth SIG, Inc.
- All other trademarks are the property of their respective owners.

Validity of this manual

This manual applies to the Leica Detection DD series locators, DA series transmitters and Detection accessories. Differences between the models are marked and described.

Available documentation

Name	Description/Format		
Leica DD220/ DD230 Series Locators & Accessories Quick Guide	Provides an overview of the product together with technical data and safety directions. Intended as a quick reference field guide.	✓	✓
Leica DD220/ DD230 Series Locators & Accessories User Manual	All instructions required in order to operate the product to a basic level are contained in the User Manual. Provides an overview of the product together with technical data and safety directions.		✓



Service	Description
myProducts	Add all products that you and your company own and explore your world of Leica Geosystems: View detailed information on your products and update your products with the latest software and keep up-to-date with the latest documentation.

Service	Description
myService	View the current service status and full service history of your products in Leica Geosystems service centres. Access detailed information on the services performed and download your latest calibration certificates and service reports.
mySupport	Create new support requests for your products that will be answered by your local Leica Geosystems Support Team. View the complete history of your support requests and view detailed information on each request in case you want to refer to previous support requests.
myTraining	Enhance your product knowledge with Leica Geosystems Campus - Information, Knowledge, Training. Study the latest online training material on your products and register for seminars or courses in your country.
myTrustedServices	Add your subscriptions and manage users for Leica Geosystems Trusted Services, the secure software services, that assist you to optimise your workflow and increase your efficiency.

Table of Contents

1	Safety Directions	6
1.1	General	6
1.2	Definition of Use	6
1.3	Limits of Use	7
1.4	Responsibilities	7
1.5	Hazards of Use	8
	1.5.1 General	8
	1.5.2 Using the Product with a Signal Transmitter	12
1.6	Electromagnetic Compatibility EMC	13
1.7	FCC Statement, Applicable in U.S.	14
2	Description of the System	17
2.1	System Information	17
2.2	System Components	17
2.3	Locator Components	18
2.4	Signal Transmitter Components	18
2.5	Li-Ion Battery Pack	18
3	Operation of the Locator	20
3.1	Keyboard	20
3.2	Turning On / Turning Off	20
3.3	Display Screens	20
	3.3.1 The Customisation Screens	20
	3.3.2 The Locate Screen	22
	3.3.3 The Depth Estimation Screens	23
3.4	Locator Menu	26
	3.4.1 Access and Navigation	26
	3.4.2 Menu Options	27
3.5	Search Modes	30
4	Operation of the Transmitter	34
4.1	Keyboard	34
4.2	Turning On / Turning Off	34
5	Applications	35
5.1	How to Pinpoint a Utility	35
5.2	How to Trace a Utility	36
5.3	How to Conduct a Sweep Search	36
5.4	Using the Transmitter in Induction Mode	38
	5.4.1 General Information	38
	5.4.2 Induction Mode: Nulling-Out Method	39
	5.4.3 Induction Mode: Parallel-Sweep Method	40
	5.4.4 Induction Mode: Radial-Sweep Method	41
5.5	Using the Transmitter in Connection Mode	42
	5.5.1 General Information	42
	5.5.2 Direct Connection Mode	43
	5.5.3 Connection Mode: 131 KHZ Cable-Wrap Technique	44
5.6	How to Use the Trace Rod	46
	5.6.1 General Information	46
	5.6.2 Locating a Utility Using the Trace Rod	47
5.7	How to Use the Transmitter Clamps	50
	5.7.1 General Information	50
	5.7.2 Using a Transmitter Clamp to connect to Cable Utilities	50
5.8	How to Use the Property Plug Connector	51
	5.8.1 General Information	51

5.8.2	Locating a Utility Using the Property Plug Connector	51
5.9	How to Use the Sondes	52
5.9.1	General Information	52
6	Estimating Depth and Current of a Utility	55
6.1	Utility Line Depth	55
6.2	Sonde Depth	56
6.3	Depth Code Information	56
6.4	Utility Current Measurement	57
7	Connectivity	58
7.1	Locator Bluetooth Connectivity	58
7.2	Locator USB Connectivity	60
7.3	Transmitter USB Connectivity	60
8	Locator Memory and GPS	62
8.1	Internal Memory	62
8.2	Internal GPS	62
8.3	Point of Interest	62
9	Batteries	64
9.1	Operating Principles	64
9.2	Charging the Li-Ion Battery Pack	64
10	Functional Checks	67
10.1	Locator Health Check	67
10.2	Calibration Verification	68
10.3	Locator Fault Codes	70
10.4	Functional Check of the Transmitter	70
10.5	Functional Check of the Trace Rod	71
10.6	Functional Check of the Sonde	72
11	Care and Transport	74
11.1	Transport	74
11.2	Storage	74
11.3	Cleaning and Drying	74
12	Technical Data	75
12.1	Conformity to National Regulations	75
12.2	Transmitter Technical Data	75
12.3	Locator Technical Data	76
12.4	Conductive Rod Technical Data	79
12.5	Property Plug Connector Technical Data	79
Appendix A	Time Zone Offsets	81

1 Safety Directions

1.1 General

Description

The following directions enable the person responsible for the product, and the person who actually uses the equipment, to anticipate and avoid operational hazards.

The person responsible for the product must ensure that all users understand these directions and adhere to them.

About warning messages





Warning messages are an essential part of the safety concept of the instrument. They appear wherever hazards or hazardous situations can occur.

Warning messages...

- make the user alert about direct and indirect hazards concerning the use of the product.
- contain general rules of behaviour.

For the users' safety, all safety instructions and safety messages shall be strictly observed and followed! Therefore, the manual must always be available to all persons performing any tasks described here.

DANGER, WARNING, CAUTION and **NOTICE** are standardised signal words for identifying levels of hazards and risks related to personal injury and property damage. For your safety, it is important to read and fully understand the following table with the different signal words and their definitions! Supplementary safety information symbols may be placed within a warning message as well as supplementary text.

Type	Description
 DANGER	Indicates an imminently hazardous situation which, if not avoided, will result in death or serious injury.
 WARNING	Indicates a potentially hazardous situation or an unintended use which, if not avoided, could result in death or serious injury.
 CAUTION	Indicates a potentially hazardous situation or an unintended use which, if not avoided, may result in minor or moderate injury.
NOTICE	Indicates a potentially hazardous situation or an unintended use which, if not avoided, may result in appreciable material, financial and environmental damage.
	Important paragraphs which must be adhered to in practice as they enable the product to be used in a technically correct and efficient manner.

1.2 Definition of Use

Intended use

The products are intended to be used for the following applications:

General

- Detection and localisation of underground utilities: metallic cables and pipes.

Locator

- Detection and localisation of utilities with the use of approved accessories or a signal transmitter.
- Estimation of the depth of an underground utility, or accessory.

Locator with Bluetooth:

- Data communication with external appliances.

Locator with Internal Memory:

- Recording and storage of product usage.

Locator with GPS:

- Localisation, recording and storage of product usage.

Reasonably foreseeable misuse

- Use of the product without instruction.
- Use outside of the intended use and limits.
- Disabling safety systems.
- Removal of hazard notices.
- Opening the product using tools, for example screwdriver, unless this is permitted for certain functions.
- Modification or conversion of the product.
- Use after misappropriation.
- Use of products with recognisable damages or defects.
- Use with accessories from other manufacturers without the prior explicit approval of Leica Geosystems.
- Inadequate safeguards at the working site.

1.3

Limits of Use

Environment

Suitable for use in an atmosphere appropriate for permanent human habitation: not suitable for use in aggressive or explosive environments.

WARNING

Working in hazardous areas, or close to electrical installations or similar situations.

Life Risk.

Precautions:

- ▶ Local safety authorities and safety experts must be contacted by the person responsible for the product before working in such conditions.

1.4

Responsibilities

Manufacturer of the product

Leica Geosystems AG, CH-9435 Heerbrugg, hereinafter referred to as Leica Geosystems, is responsible for supplying the product, including the user manual and original accessories, in a safe condition.

Person responsible for the product

The person responsible for the product has the following duties:

- To understand the safety instructions on the product and the instructions in the user manual.
- To ensure that it is used in accordance with the instructions.
- To be familiar with local regulations relating to safety and accident prevention.
- To inform Leica Geosystems immediately if the product and the application becomes unsafe.
- To ensure that the national laws, regulations and conditions for the operation of the product are respected.

1.5

Hazards of Use

1.5.1

General

CAUTION

Dropping, misusing, modifying, storing the product for long periods or transporting the product

Watch out for erroneous measurement results.

Precautions:

- ▶ Periodically carry out test measurements and perform the field adjustments indicated in the User Manual, particularly after the product has been subjected to abnormal use as well as before and after important measurements.

DANGER

Because of the risk of electrocution, it is dangerous to use the product in the vicinity of electrical installations such as power cables or electrical railways.

Precautions:

- ▶ Keep at a safe distance from electrical installations. If it is essential to work in this environment, first contact the safety authorities responsible for the electrical installations and follow their instructions.

WARNING

Working on or near live electrical utilities may cause you to receive an electric shock.

Precautions:

- ▶ Do not exceed equipment's recommended ratings and instructions of use.
 - ▶ Inspect equipment's cables and accessories for damage, do not use if faulty.
 - ▶ Do not work on electrically live power utilities unless you are properly qualified.
 - ▶ Use personal protective equipment rated for the utilities voltage and current.
 - ▶ Familiarise yourself with National and Work regulations governing safety and accident prevention.
-

 **WARNING**

Distraction/loss of attention

During dynamic applications, for example stakeout procedures, there is a danger of accidents occurring if the user does not pay attention to the environmental conditions around, for example obstacles, excavations or traffic.

Precautions:

- ▶ The person responsible for the product must make all users fully aware of the existing dangers.
-

 **WARNING**

The absence of a positive indication does not guarantee the non-existence of a utility.

Utilities without a detectable signal may be present.

The locators can only locate non-metallic utilities such as plastic pipes, typically used by the water and gas utilities, with the use of appropriate accessories.

Precautions:

- ▶ Always excavate with care.
-

 **WARNING**

Depth reading on locator might differ from actual depth of utility

When taking a depth reading, the depth is calculated as distance to the centre of a utility or to a sonde within the utility. Depending on the diameter of a utility, the depth reading might differ from the actual depth of the utility. This specifically applies when the signal for depth estimation is produced by a sonde lying in a large-diameter pipe or duct.

Precautions:

- ▶ Always take into account allowances for the diameter of a utility.
-

 **WARNING**

Inadequate securing of the working site.

This can lead to dangerous situations, for example in traffic, on building sites and at industrial installations.

Precautions:

- ▶ Always ensure that the working site is adequately secured.
 - ▶ Adhere to the regulations governing safety, accident prevention and road traffic.
-

 **CAUTION**

Inappropriate mechanical influences to batteries

During the transport, shipping or disposal of batteries it is possible for inappropriate mechanical influences to constitute a fire hazard.

Precautions:

- ▶ Before shipping the product or disposing of it, discharge the batteries by running the product until they are flat.
- ▶ When transporting or shipping batteries, the person in charge of the product must ensure that the applicable national and international rules and regulations are observed.
- ▶ Before transportation or shipping contact your local passenger or freight transport company.

 **WARNING**

A hazardous signal can be present at the transmitter output when used in connection mode and on the attached accessories and live utility itself.

Precautions:

- ▶ Take care when handling exposed or non-insulated connections. Notify others who may be working on or around the utility.

 **WARNING**

Exposure of batteries to high mechanical stress, high ambient temperatures or immersion into fluids

This can cause leakage, fire or explosion of the batteries.

Precautions:

- ▶ Protect the batteries from mechanical influences and high ambient temperatures. Do not drop or immerse batteries into fluids.

 **WARNING**

Short circuit of battery terminals

If battery terminals are short circuited e.g. by coming in contact with jewellery, keys, metallised paper or other metals, the battery can overheat and cause injury or fire, for example by storing or transporting in pockets.

Precautions:

- ▶ Make sure that the battery terminals do not come into contact with metallic objects.

⚠ WARNING

Unauthorised opening of the product

Either of the following actions may cause you to receive an electric shock:

- Touching live components
- Using the product after incorrect attempts were made to carry out repairs

Precautions:

- ▶ Do not open the product!
- ▶ Only Leica Geosystems authorised service centres are entitled to repair these products.

⚠ WARNING

Improper disposal

If the product is improperly disposed of, the following can happen:

- If polymer parts are burnt, poisonous gases are produced which may impair health.
- If batteries are damaged or are heated strongly, they can explode and cause poisoning, burning, corrosion or environmental contamination.
- By disposing of the product irresponsibly you may enable unauthorised persons to use it in contravention of the regulations, exposing themselves and third parties to the risk of severe injury and rendering the environment liable to contamination.

Precautions:

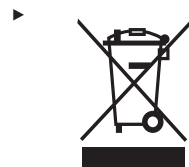

The product must not be disposed with household waste. Dispose of the product appropriately in accordance with the national regulations in force in your country. Always prevent access to the product by unauthorised personnel.

Product-specific treatment and waste management information can be received from your Leica Geosystems distributor.

⚠ WARNING

Improperly repaired equipment

Risk of injuries to users and equipment destruction due to lack of repair knowledge.

Precautions:

- ▶ Only Leica Geosystems authorised service centres are entitled to repair these products.

 DANGER**Clipping a transmitter clamp around a live utility**

When a transmitter clamp is clipped around a live utility, a hazardous signal might be present on the utility or at the transmitter plug connector, causing you to receive an electric shock.

Precautions:

- ▶ Do not clip a transmitter clamp around live utilities that have impaired or no insulation.
 - ▶ Always ensure that the transmitter plug connector is connected to the transmitter before you clip the transmitter clamp around a live utility.
-

 DANGER**Connecting the cable set of the transmitter to a live utility**

Connecting the cable set of the transmitter directly to a live utility can cause you to receive an electric shock.

Precautions:

- ▶ Never connect the cable set of the transmitter directly to a live electrical utility.
-

 DANGER**Power output of signal transmitter**

The signal transmitter can output potentially lethal voltages!

Precautions:

- ▶ Take care when using the maximum power output of the signal transmitter.
 - ▶ Take care when handling exposed or non-insulated connections, including the transmitter's cable set, the earth pin and the connection to the utility.
 - ▶ Notify others who may be working on or around the utility.
-

 WARNING**Removing the battery pack of the signal transmitter**

Removing the battery pack of the signal transmitter might cause you to receive an electric shock.

Precautions:

- ▶ Switch the signal transmitter off and remove any cable set or accessories from the connection socket before removing the battery pack.
-

 WARNING**Battery pack of the signal transmitter may get hot after prolonged use.**

Risk of burning injuries.

Precautions:

- ▶ Avoid touching the hot battery pack.
 - ▶ Allow the battery pack to cool down before removing it.
-

1.6

Electromagnetic Compatibility EMC

Description

The term Electromagnetic Compatibility is taken to mean the capability of the product to function smoothly in an environment where electromagnetic radiation and electrostatic discharges are present, and without causing electromagnetic disturbances to other equipment.

WARNING

Electromagnetic radiation

Electromagnetic radiation can cause disturbances in other equipment.

Precautions:

- ▶ Although the product meets the strict regulations and standards which are in force in this respect, Leica Geosystems cannot completely exclude the possibility that other equipment may be disturbed.

CAUTION

Use of the product with accessories from other manufacturers. For example field computers, personal computers or other electronic equipment, non-standard cables or external batteries

This may cause disturbances in other equipment.

Precautions:

- ▶ Use only the equipment and accessories recommended by Leica Geosystems.
- ▶ When combined with the product, they meet the strict requirements stipulated by the guidelines and standards.
- ▶ When using computers, two-way radios or other electronic equipment, pay attention to the information about electromagnetic compatibility provided by the manufacturer.

CAUTION

Intense electromagnetic radiation. For example, near radio transmitters, transponders, two-way radios or diesel generators

Although the product meets the strict regulations and standards which are in force in this respect, Leica Geosystems cannot completely exclude the possibility that function of the product may be disturbed in such an electromagnetic environment.

Precautions:

- ▶ Check the plausibility of results obtained under these conditions.

CAUTION

Electromagnetic radiation due to improper connection of cables

If the product is operated with connecting cables attached at only one of their two ends, for example external supply cables, interface cables, the permitted level of electromagnetic radiation may be exceeded and the correct functioning of other products may be impaired.

Precautions:

- ▶ While the product is in use, connecting cables, for example product to external battery, product to computer, must be connected at both ends.

WARNING

Use of product with radio or digital cellular phone devices

Electromagnetic fields can cause disturbances in other equipment, in installations, in medical devices, for example pacemakers or hearing aids and in aircraft. It can also affect humans and animals.

Precautions:

- ▶ Although the product meets the strict regulations and standards which are in force in this respect, Leica Geosystems cannot completely exclude the possibility that other equipment can be disturbed or that humans or animals can be affected.
- ▶ Do not operate the product with radio or digital cellular phone devices in the vicinity of filling stations or chemical installations, or in other areas where an explosion hazard exists.
- ▶ Do not operate the product with radio or digital cellular phone devices near to medical equipment.
- ▶ Do not operate the product with radio or digital cellular phone devices in aircraft.
- ▶ Do not operate the product with radio or digital cellular phone devices for long periods with the product immediately next to your body.

1.7

FCC Statement, Applicable in U.S.



The greyed paragraph below is only applicable for products without radio.

⚠ WARNING

This equipment has been tested and found to comply with the limits for a Class B digital device, pursuant to part 15 of the FCC rules.

These limits are designed to provide reasonable protection against harmful interference in a residential installation.

This equipment generates, uses and can radiate radio frequency energy and, if not installed and used in accordance with the instructions, may cause harmful interference to radio communications. However, there is no guarantee that interference will not occur in a particular installation.

If this equipment does cause harmful interference to radio or television reception, which can be determined by turning the equipment off and on, the user is encouraged to try to correct the interference by one or more of the following measures:

- Reorient or relocate the receiving antenna.
- Increase the separation between the equipment and the receiver.
- Connect the equipment into an outlet on a circuit different from that to which the receiver is connected.
- Consult the dealer or an experienced radio/TV technician for help.

⚠ CAUTION



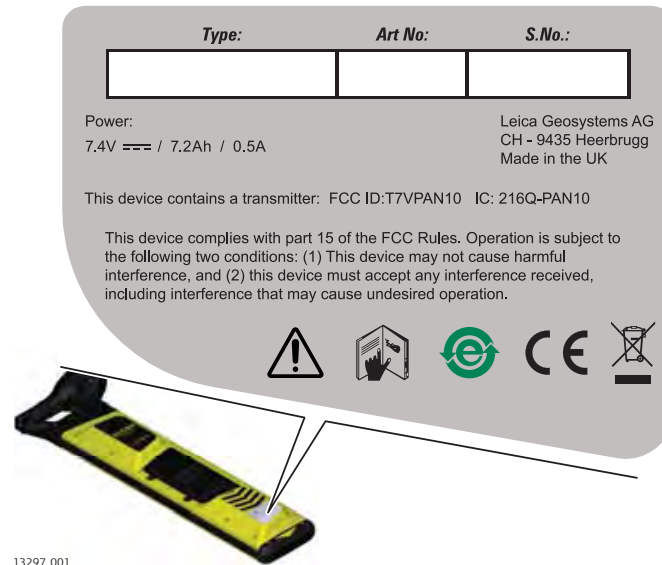

Changes or modifications not expressly approved by Leica Geosystems for compliance could void the user's authority to operate the equipment.

**Labelling
DD220/DD230**



Labelling DA series transmitters

Power: 7.4V  / 7.2Ah / 0.5A
Leica Geosystems AG
CH - 9435 Heerbrugg
Switzerland

<input type="text"/>	<input type="text"/>	<input type="text"/>
Type	Art.No.	Ser.No.

This device complies with part 15 of the FCC Rules. Operation is subject to the following two conditions:
(1) This device may not cause harmful interference, and (2) this device must accept any interference received, including interference that may cause undesired operation.

Made in the UK



13298_001

2

Description of the System

2.1

System Information

General description

Locators are used to detect buried conductive utilities that emit an electromagnetic signal. Such a signal is generated as an electrical current passes through the utility.

Signal transmitters are used to apply a distinct signal to utilities with the following intention:

- To improve the detection success.
- To trace the route of a utility.
- To make a depth or current measurement.

Accessories are used with the locator and transmitter to localise the position of utilities, including some that are non-metallic.

The locators and transmitters described within this manual greatly facilitate the search process and help to reduce the dangers and costs associated with utility strikes. However, electromagnetic location depends on the utilities being conductive (metallic) and emitting a signal as current passes through them.

☞ Keep in mind that a locator on its own cannot detect all utilities. Take care when excavating. We recommend that you adopt a safe system which includes the planning of the search process in advance, the use of utility maps, the use of locators and transmitters, and the use of safe digging practices.

2.2

System Components



The delivered components depend on the package ordered.

Available system components

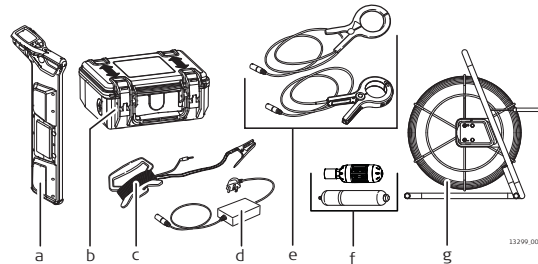

- a Locator
- b Transmitter
- c Transmitter Cable Set Extension
- d Property Plug Connector
- e Transmitter Clamps
- f Sondes
- g Trace Rod (non-metallic utility tracer)

2.3

Locator Components

Description of components DD220/ DD230 locators

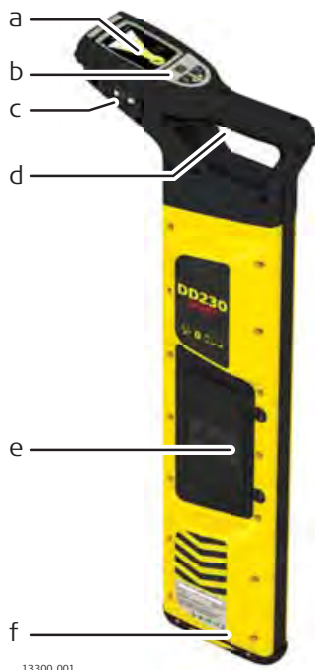

- a Display
- b Locator keyboard
- c USB port
- d Trigger
- e Battery compartment
- f Locator foot (wear part)

2.4

Signal Transmitter Components

Description of transmitter components



- a Accessory compartment
- b Connection socket
- c Battery compartment and USB port
- d Signal transmitter keyboard
- e Speaker
- f Induction arrow

2.5

Li-Ion Battery Pack

Li-Ion battery pack

The Li-Ion battery pack is delivered with an energy content as low as possible and needs to be woke up prior to use.

To wake up the Li-Ion battery pack, do the following:

1. Connect the charger plug into the charge jack on the battery pack.



2. Plug the connector into a suitable power source.

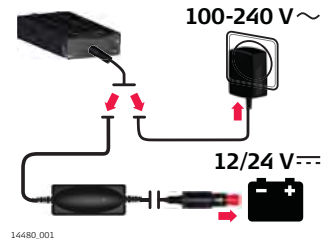

The battery pack should be fully charged before use.



Result:

The small LED next to the charge jack flashes at a fast rate to indicate the wake up process, then flashes at a slower rate to indicate that the battery pack is active and charging.



Applicable to the DD220/DD230 locators and DA Signal Transmitters.

3 Operation of the Locator

3.1 Keyboard

DD220/DD230 locator keyboard

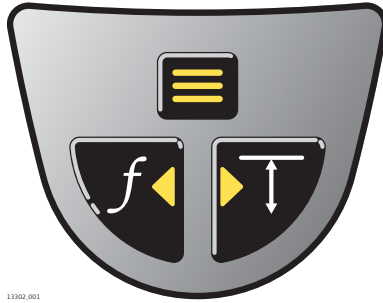

Function key

Press and release to change the search mode.



Depth Estimation key

Press and release to take a depth reading.



Menu key

Press and hold to display the Locator main menu or to return back to the locate screen.

Press and release to select a menu option.



Left navigation key

Press and release to select the previous menu option.



Right navigation key

Press and release to select the next menu option.

3.2 Turning On / Turning Off

Turning on and off the DD220/DD230

Press and hold the trigger to turn on and operate the locator.
Release the trigger to turn off the locator.

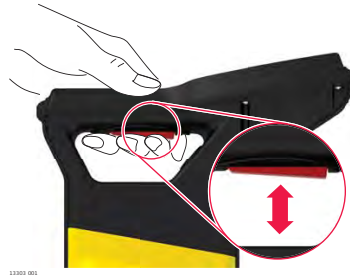

3.3 Display Screens

3.3.1 The Customisation Screens

Set the regional preferences

The customisation screens are displayed only for the first time the locator is put into operation. The screens allow you to set the locator to your regional preferences.

1. Use the navigation keys to alter the selection.



2. Press the menu key to confirm the selection.



Units of Measurement

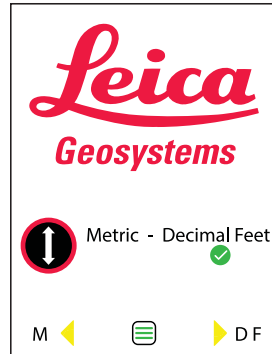

14329.001

This screen allows you to set up your preferred units of measurement for depth estimation.



To change the units of measurement later on, use the menu option in the Settings menu. Refer to " Submenu Settings" within "3.4.2 Menu Options".



Time Zone Settings (model specific option)



14330.001

This screen allows you to adjust the time zone settings to suit your geographic region. The default time is Universal Time Coordinate (UTC). Time zone offsets are shown in Appendix A Time Zone Offsets. Set up the hours and minutes.

Confirmation Screen

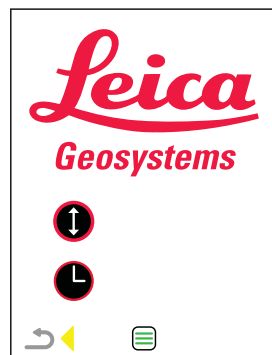

14331.001

This screen allows you to confirm your changes or to return to the previous screens and update the settings.

To confirm your settings, press the menu key.

To return and update, press the left navigation key.

3.3.2

The Locate Screen

Description of the screen

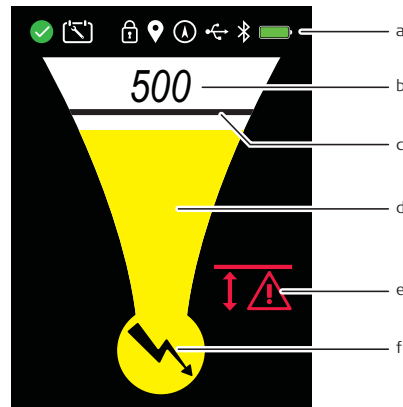

- 13146.001
- a) **Status bar**
Provides information on product and feature selection
 - b) **Numeric Peak Indicator**
 - Increases when approaching a utility or sonde and decreases when moving away.
 - Provides the highest peak reading when directly over the utility or sonde.
 - Can be used to distinguish between utilities when a signal transmitter is used.
 - c) **Peak Indicator**
 - Indicates the highest peak reading on the locate scale.
 - Remains at the peak position for a short period of time before falling back.
 - d) **Locate Scale**
 - Increases when approaching a utility or sonde and decreases when moving away.
 - Provides a peak reading when directly over the utility or sonde.
 - e) **Alerts**
Alerts are displayed to indicate hazardous situations or incorrect use.
 - f) **Search Mode Indicator**
Displays the currently selected search mode.

Status bar icons

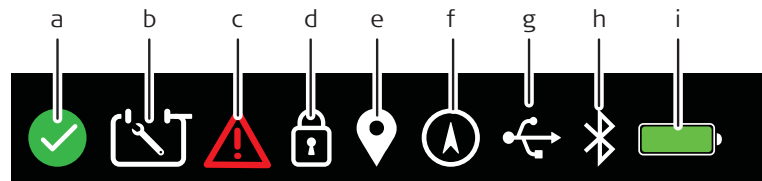

13147.001

- a) **Health Check**
 - ✓ Health Check passed within the last 24 hours.
 - ✗ Health Check process prohibited, e.g. if Health Check is activated in high levels of electrical interference.
- b) **Scheduled Maintenance**
Planned maintenance is due for the locator. To adjust the settings, refer to " Submenu Maintenance" ("3.4.2 Menu Options").
- c) **Fault Alert**
Indicates a potential product defect.
- d) **Mode Lock**
Locator starts up in the search mode that was used last.
- e) **Point of Interest**
Model-specific option. Refer to "8.3 Point of Interest".
- f) **GPS status**
Model-specific option. Refer to "8.2 Internal GPS".
- g) **USB status**
Refer to "7.2 Locator USB Connectivity".
- h) **Bluetooth status**
Model-specific option. Refer to "7.1 Locator Bluetooth Connectivity".
- i) **Battery condition**
 Battery Low. Refer to "9 Batteries".

Locate alerts

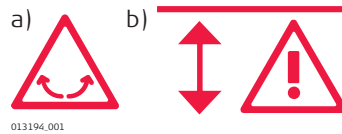

- a) **Swing Alert**
Indicates excessive swinging during use. To adjust the settings, refer to "Submenu Alerts" ("3.4.2 Menu Options").
- b) **Hazard Zone**
Indicates the close proximity of a utility. Works in all search modes except in Radio mode. To adjust the settings, refer to " Submenu Alerts" ("3.4.2 Menu Options").

3.3.3

The Depth Estimation Screens

Utility line depth

This screen indicates the depth of a buried utility.

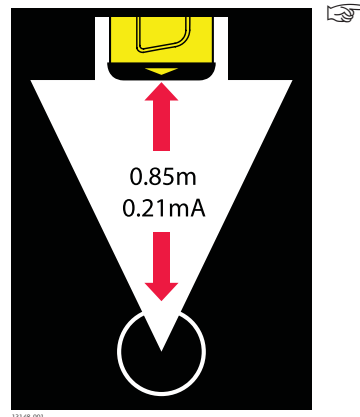

Note that the depth is calculated as distance to the centre of the utility!

Sonde depth

This screen indicates the depth of a sonde within a pipe.

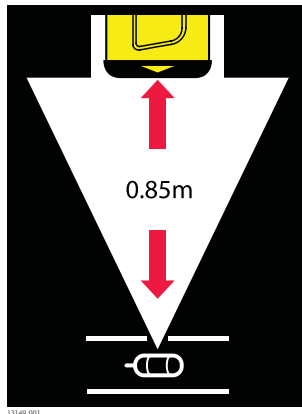

Note that the depth is calculated as distance to the sonde within the pipe!

Depth out of range

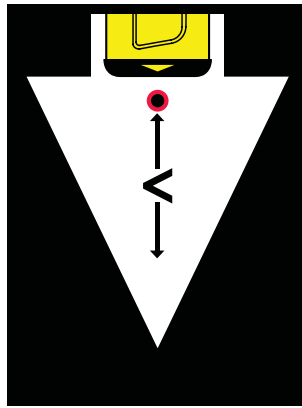

This screen indicates that the depth of the utility or sonde is less than the minimum depth range.

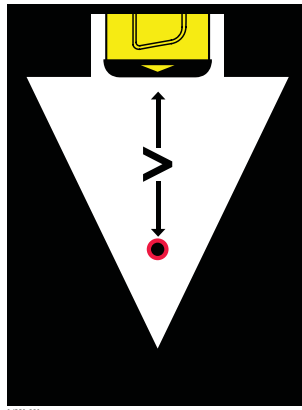

This screen indicates that the depth of the utility or sonde is greater than the maximum depth range.

Signal out of range

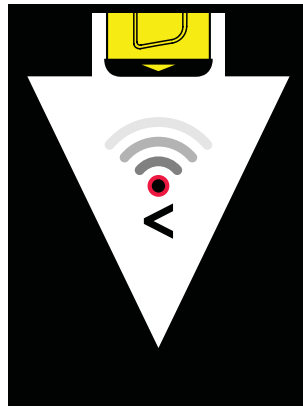

This screen indicates that the signal source is too low to provide a depth reading.



This screen indicates that the signal source is too high to provide a depth reading.

3.4

Locator Menu

3.4.1

Access and Navigation





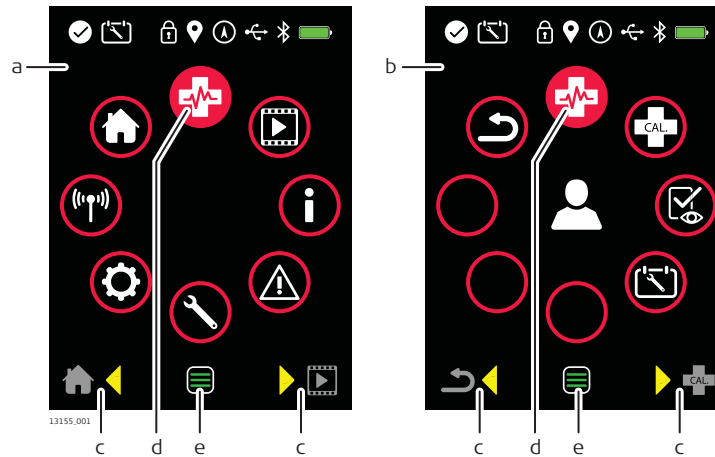





Locator main menu and submenus

The Locator menu is used to display information or to update settings. A main menu is used to display the main categories. A submenu displays the available options for the selected category.



- a Locator main menu
- b Submenu (Example)
- c On-screen guidance arrows that indicate the previous and next menu option.
- d Currently highlighted menu option.
- e On-screen menu icon. A green icon indicates an accessible option, a grey icon indicates a read-only option.

How to access and navigate through the menu

-  The Locator must be switched on throughout the process.
-  Press and hold the menu key to display the Locator main menu.
 -  When displaying the main menu, the option **Health Check** is highlighted by default.
-  Use the navigation keys to highlight a menu option.
-  Press and release the menu key to select the highlighted option.
The submenu for the selected option is displayed.
-  Use the navigation keys to highlight a menu option.
-  Press and release the menu key to select the highlighted option.
-  Use the navigation keys to adjust the option.
-  Press and release the menu key to confirm the changes and return to the submenu.
-  Select this option to go back one level.



Select this option to close the menu and display the Locate screen.
 You can also press and hold the menu key to display the Locate screen.

Commonly used menu icons

Icon	Description
	This icon indicates an active option or a good condition.
	This icon indicates an inactive option or a failed condition.
	This icon indicates a prohibited use or a fault.
	This icon indicates a user defined or activated option.

3.4.2

Menu Options

Main menu



Select this option to perform a Health Check.
Health Check is a function check on the locators hardware and software.
 Refer to "10.1 Locator Health Check".



Videos.
 Contains short animations on key product features or product usage.



Information.
 Contains options for product and owner information.



Alerts.
 Contains options for alerts and configuration.



Home.
 Select this option to return to the Locate screen.



Communication.
 Contains options for communication (connectivity) and configuration.



Settings.
 Contains options for product settings and configuration.



Maintenance.
 Contains options for maintenance and configuration.

Submenu Videos



Select from the main menu.



Select this option to play a short animation on how to use the locator in Power or Radio mode.



Select this option to play a short animation on how to use the locator with the signal transmitter in Connection Mode.



Select this option to play a short animation on how to use the locator with the signal transmitter in Induction mode.



Select this option to play a short animation on how to use the locator with a sonde.



Select this option to play a short animation on how to perform a product Health Check.



Select this option to play a short animation on how to perform a calibration verification.



Select this option to return to the main menu.

Submenu Information



Select **i** from the main menu.



Select this option to display company or owner information.



Select this option to display company or owner telephone number.



Select this option to display user name or fleet number.



Select this option to display product information, for example serial number.



Select this option to display the e-mail address.



Select this option to display the web address.



Select this option to return to the main menu.

Submenu Alerts



Select **⚠** from the main menu.



Select this option to adjust the Hazard Zone activation point.
Available settings:

- **✗** (OFF): Alert function is not active.
- 0.3 m (12 inches): Alert is displayed if a utility is detected within the defined range.
- 0.5 m (20 inches): Alert is displayed if a utility is detected within the defined range.



Select this option to adjust the Swing Alert settings.
Available settings:

- **✓** (ON)
- **✗** (OFF)



Select this option to display the fault code.

⚠ Indicates a product fault. The fault code is displayed. For a list of fault codes, refer to "10.3 Locator Fault Codes".

✔ Indicates that the product condition is good.



Select this option to return to the main menu.

Submenu Maintenance



Select  from the main menu.



Select this option to adjust the Health Check activation.

Available settings:

-  User defined
- **DD:** Daily
- **MM:** Monthly



Displays the number of months to the next calibration.



Select this option to display the recent maintenance history. Press and release the menu key to display the report.



Select this option to adjust the scheduled maintenance settings.

Available settings: ON (✔) or OFF (✘).



Select this option to return to the main menu.

Submenu Settings



Select  from the main menu.



Select this option to adjust the products volume level.



Select this option to adjust the Numeric Peak Indicator.

Available settings:

- ✔ (ON)
- ✘ (OFF)



Select this option to adjust the display time for the Peak Indicator.

Available settings:

- ✔ (ON)
- ✘ (OFF)



Select this option to adjust the Mode Lock setting.

Available settings:

- ✔ ON: Locator starts up in the search mode that was used last.
- ✘ OFF: Locator starts up in the default search mode.



Select this option to adjust the measurement units for depth estimation.

Available settings:

- Metric
- Decimal Feet
- ✘ Off (controlled by external software)



Select this option to adjust the Point-of-Interest setting.

Available settings:

- Select a marker in the desired colour to activate the POI function.
- Select **X** to turn off the POI function.



Select this option to adjust the display brightness.



Select this option to return to the main menu.





Select  from the main menu.



Model-specific option:

Select this option to adjust the products Bluetooth options.

Available settings:

-  DD SMART
- **BT1:** Backward compatibility with Bluetooth-enabled iSeries locators.
- **BT2:** Backward compatibility with Bluetooth-enabled iSeries locators.
-  User configurable option, can be customised using the locators management software.
- **X** Bluetooth is turned off.

Refer to "7.1 Locator Bluetooth Connectivity".





Select this option to return to the main menu.



Submenu Communication

3.5

Search Modes

Available search modes

Search Mode	Description
Auto mode	<p>Combined detection of Power and Radio modes.</p>  This mode facilitates a one-step sweep search process.
Power mode	<p>This mode is used to detect electrical cables.</p>  Power mode is dependent on an electrical current flowing through a cable. Keep in mind that not all electrical cables carry a detectable signal and thus pose a serious risk, for example supplies to unilluminated street lights, unoccupied buildings or balanced three-phase cables.
Radio mode	<p>This mode is used to detect metallic pipes or cables, including telecoms and electrical.</p>  Radio mode is dependent on reradiated radio waves originating from radio masts. Keep in mind that signal availability can vary or be restricted depending on factors including line of site, signal application or routine mast maintenance.

Search Mode	Description
Signal Transmitter mode	<p>Used in conjunction with a signal transmitter:</p> <ul style="list-style-type: none"> • To improve the detectability of utilities. • To trace a specific utility. • To make a depth or current measurement. <p> Keep in mind the following:</p> <ul style="list-style-type: none"> • Higher frequencies couple onto utilities more easily than lower frequencies. • Higher frequencies travel shorter distances; the higher the frequency the less the distance travelled. • Higher frequencies are likely to couple onto other utilities; the higher the frequency the greater the spread. • Higher frequencies are useful for avoidance activities. <p>Example: A 131 kHz frequency has a greater ability to couple onto other utilities, jump over insulated pipe joints, travel down small-diameter cables or pot-ended (terminated) cables.</p>
Sonde mode	<p>Used in conjunction with a sonde:</p> <ul style="list-style-type: none"> • To trace the route of a pipe or duct, including non-metallic variants. • To locate a blockage or collapse. • To make a depth measurement. <p> Keep in mind that various sondes are available for specific task-based applications:</p> <ul style="list-style-type: none"> • Sondes with higher frequencies are used for generic pipe or duct tracing. • Lower frequencies (512 Hz, 640 Hz) work best for metal pipes.

WARNING

The absence of a positive indication does not guarantee the non-existence of a utility.

Utilities without a detectable signal may be present.

The locators can only locate non-metallic utilities such as plastic pipes, typically used by the water and gas utilities, with the use of appropriate accessories.

Precautions:

- ▶ Always excavate with care.

How to select a search mode



Press the Function key on the locator keyboard to select a search mode.

The Search Mode indicator cycles through in the following order:

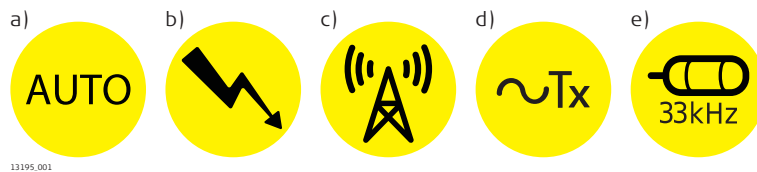

- a) Auto Mode
- b) Power Mode
- c) Radio Mode
- d) Signal Transmitter Mode
- e) Sonde Mode

Frequency selection

Using the locator with a signal transmitter



The Signal Transmitter mode features an auto-select option (indicated by ~TX). In Auto mode the locator locks onto the signal transmitters output and updates the Search Mode indicator with the selected frequency.



 Auto mode is influenced by the ability to detect the signal transmitters output. For long distance tracing or low signal outputs it is recommended to manually select the required frequency on the locator.

Using the locator with a sonde

The default search mode when using a sonde is Sonde Mode (33 kHz).

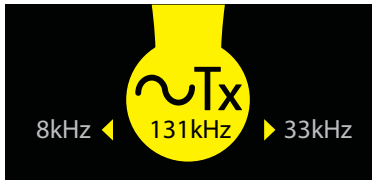
Manual selection of a signal transmitter or sonde frequency

Action	Result
1. Press the Function key to select either the Signal Transmitter or the Sonde mode. 	
2. Press and release the menu key. 	<i>The Search Mode indicator displays the currently selected frequency. The on-screen guidance arrows indicate the previous and next frequency value.</i>
3. Use the navigation keys to select the required frequency. 	

Action	Result
<p>4. Press and release the menu key to confirm the selection.</p> 	<p><i>The Search Mode indicator displays the selected frequency.</i></p>  <p>13325.001</p>
 <p>To save the selection throughout the locator's use, set the Mode Lock setting to ON. Refer to " Submenu Settings" within "3.4.2 Menu Options".</p>	

4 Operation of the Transmitter

4.1 Keyboard

Transmitter keyboard

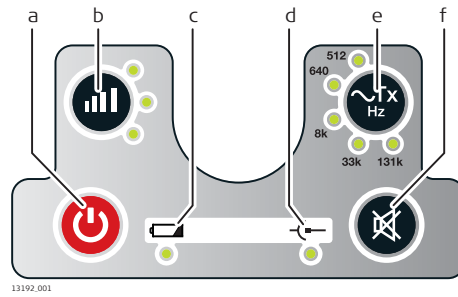

- a Power key
- b Power Output key and LED indicators
- c Low Battery LED indicator
- d Connection Mode LED indicator
- e Frequency key and LED indicators
- f Mute key

4.2 Turning On / Turning Off

Turning on and off the transmitter

Press the Power key to turn the transmitter on or off.

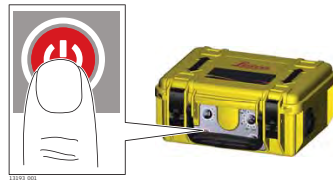

5

Applications

5.1

How to Pinpoint a Utility

Pinpointing process

To help you pinpoint a utility, the locator provides a visual and an audible response.

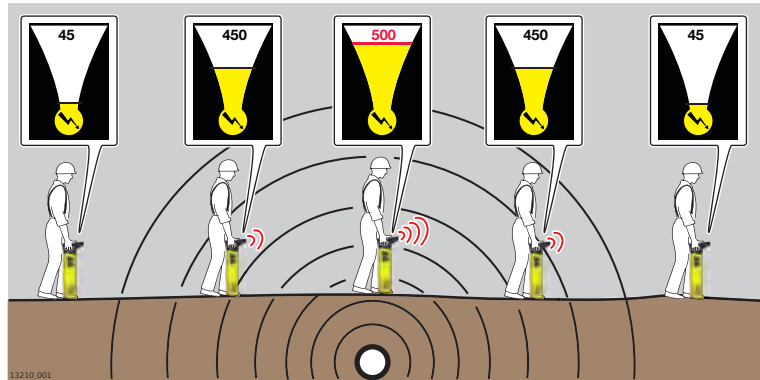

Visual response

When the locator is positioned directly over a utility and at 90° to it, the Locate screen displays a peak reading. Refer to "3.3.2 The Locate Screen".

Locate Scale



- Increases when approaching a utility or sonde and decreases when moving away.
- Provides a peak reading when directly over the utility or sonde.
- Decreases when moving away from the utility.

Peak Indicator



- Indicates the highest peak reading on the locate scale.
- Remains at the peak position for a short period of time before falling back.

Numeric Peak Indicator

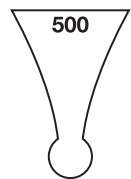

- Increases when approaching a utility or sonde and decreases when moving away.
- Provides the highest peak reading when directly over the utility or sonde.
- Decreases when moving away from the utility.
- Can be used to distinguish between utilities when a signal transmitter is used.

Audible response

To assist in the pinpointing process, the audio output automatically adjusts over the peak reading to provide a narrower response.



Mark the position of a utility with marker paint, pegs, flags or something similar. Never drive pegs into the ground over the utility!



The signal strength indicators do not indicate the size, depth or type of a utility.



To ascertain an estimated depth of the utility, use a signal transmitter or a sonde. Refer to "6 Estimating Depth and Current of a Utility".

5.2

How to Trace a Utility

Tracing process

1. Pinpoint a utility by finding the peak reading. The peak reading is found when the locator is positioned directly over a utility and at 90° to it.

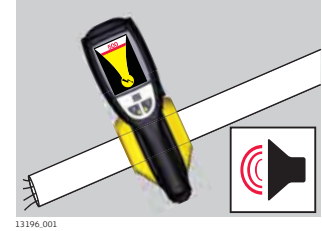

2. Rotate the Locator around its axis until the signal strength indicators are at a minimum.

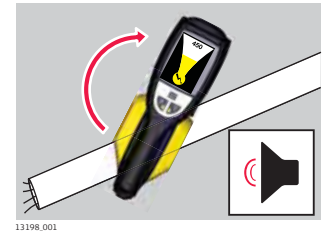

3. When the signal strength indicators are at a minimum, the blade of the locator is in line with the utility and indicates its direction.

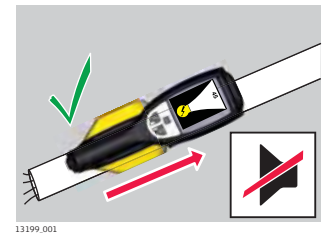

4. Trace the route of the utility by repeating the following process:
 - Pinpoint the utility.
 - Determine the direction of the utility.
 - Follow the direction of the utility.

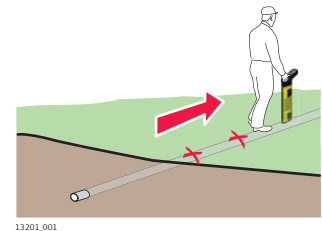

5.3

How to Conduct a Sweep Search

Sweep Search Process

Before the sweep search, define the work area to be excavated and inspect this area for signs of buried utilities, such as:

- Recent trenching
- Buried utility marker posts
- Overhead lines that run down poles and underground
- Access chamber covers

-
1. Set the locator to Power mode.



- ☞ Ensure that the locator is held upright and close to the ground. Take care not to swing the locator.

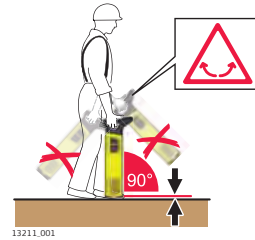

2. Cross the site from left to right until the defined area is covered.

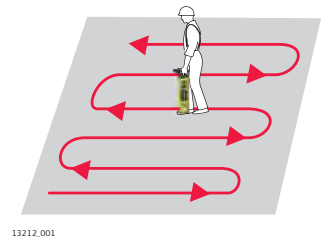

3. Turn through 90 ° and repeat the process.

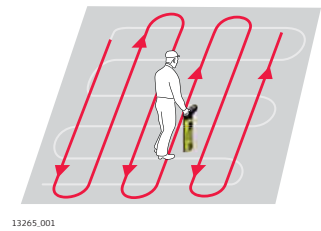

4. Pinpoint a utility by finding the peak reading. The peak reading is found when the locator is positioned directly over a utility and at 90° to it. Mark the position of a utility with marker paint, pegs, flags or something similar.

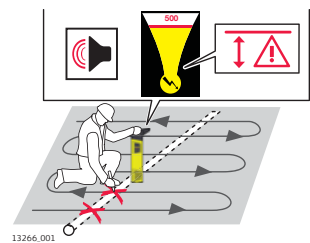

- ☞ Never drive pegs into the ground over the utility!
- ☞ Activate the Hazard Zone alert to indicate the presence of buried utilities which may be close to the surface.

5. Set the locator to Radio mode and repeat the sweep search process. Continue with this process until either a signal is detected or you are satisfied that the area has been adequately tested.





To conduct a one-step Sweep Search process or to provide a fast scan for large work areas, the locator can be used in Auto mode. To obtain an improved definition of a detected utility, use the locator in an individual mode.

5.4

Using the Transmitter in Induction Mode

5.4.1

General Information

Induction mode

Induction is a quick and simple way to apply a signal to a utility without the need to make any physical connection to it. The transmitter uses an internal aerial to transmit the signal to the utility.

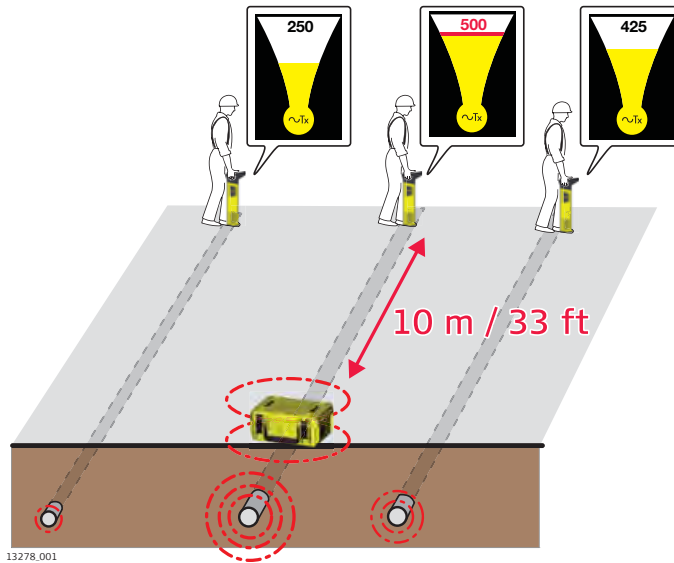

Work at least 10 m/33 ft away from the transmitter to avoid airborne signals. Reposition the Transmitter if necessary.



Coupling efficiency is best at 33 kHz.



The signal can also apply itself to other utilities within close proximity to the transmitter, depending on their depth and direction.



To increase the battery life and to reduce the possibility that the signal is applied to adjacent utilities, reduce the signal output.



The Numeric Peak Indicator can be used to indicate multiple utilities or to assist tracing. The utility with the maximum value is typically the one closest to the transmitter or the one directly connected to.

Standard process for Induction mode

1. Turn on the transmitter.



Ensure that any connection cables or accessories are disconnected and the battery level is adequate.



13267.001

2. Select the required power output and frequency.

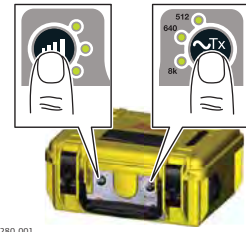

13280.001

3. Place the transmitter over the utility with the arrows running in line with the suspected direction of the utility. The internal aerial directly induces the tracing signal onto the utility.

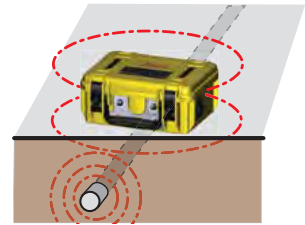

13292.001

4. Set the locator to Signal Transmitter mode and select the required frequency.



13206.001

5. Using the Sweep Search process, search the work area until either a signal is detected or you are satisfied that the area has been adequately tested. Refer to "5.3 How to Conduct a Sweep Search". Trace a utility as required. Refer to "5.2 How to Trace a Utility".

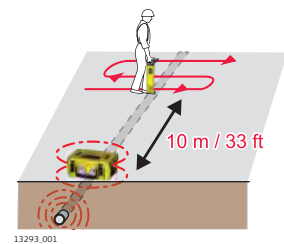

13293.001

- ☞ Maintain a distance of 10 m / 33 ft from the transmitter to avoid airborne signals and a decline in the search process. Reposition the transmitter if required.

5.4.2

Induction Mode: Nulling-Out Method

Nulling-Out method

Use the Nulling-Out method to confirm that the locator and transmitter are on the same utility or to identify hidden utilities in close proximity to each other.

- ☞ The transmitter and locator need to be set for use in induction mode. Refer to "Standard process for Induction mode".

1. Position the locator over the utility with the highest numeric signal strength.

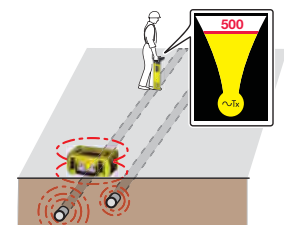

13305.001

- To confirm that the transmitter and the locator are on the same utility, place the signal transmitter upright and directly over the utility.

☞ Either the speaker or the connection socket should be on the ground.

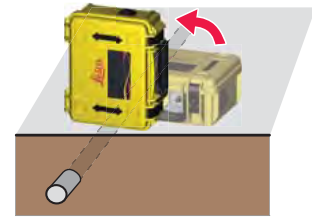

13308.001

- If the transmitter and the locator are on the same utility, the Numeric Peak Indicator on the locator significantly decreases.

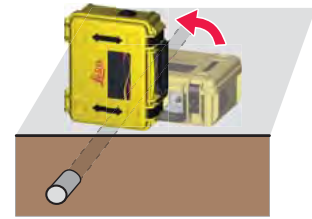

13308.001

☞ The Numeric Peak Indicator on the locator can be used to correct the position of the transmitter. Slightly move the transmitter left or right over the utility until the locate screen of the locator shows the lowest reading. It is possible to obtain the value "000".

- Using the Sweep Search process, search the work area to identify previously hidden utilities.

☞ Pinpoint and trace utilities until you are satisfied that the area has been adequately tested.

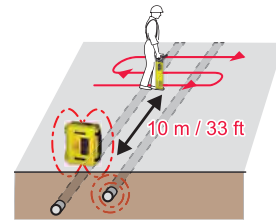

13310.001

5.4.3

Induction Mode: Parallel-Sweep Method

Parallel-Sweep method

Use the Parallel-Sweep method to cover a large area or to verify the presence of utilities before using the standard process for induction mode.

☞ Two people are required for this process: one for operating the locator and one for operating the transmitter.

☞ Set the transmitter and locator to 33 kHz.

- Person operating the transmitter:**
Hold the transmitter close to the ground with the arrows on the lid vertical and with the lid facing the person who operates the locator.

Person operating the locator:
Position the locator at a minimum distance of 10 m/33 ft away from the transmitter.

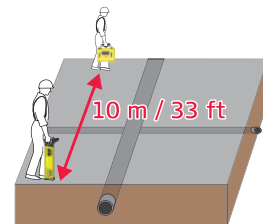

13311.001

2. **Both persons:**
Start walking parallel to each other.
- ☞ The tracing signal is induced directly onto the utility and indicated on the locator.

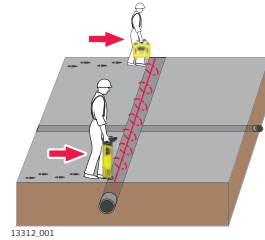

3. In the presence of a detectable utility, the locator emits a tone and the signal strength indicators rise and fall as you pass over the utility. Return to the position where the Locate screen shows a peak reading. Mark the position of a utility with marker paint, pegs, flags or something similar.

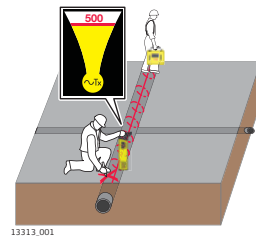

- ☞ Never drive pegs into the ground over the utility!
- ☞ To trace a specific utility, use the pinpointing and tracing methods. Refer to "5.1 How to Pinpoint a Utility" and "5.2 How to Trace a Utility".

4. Turn through 90 ° and repeat the process.

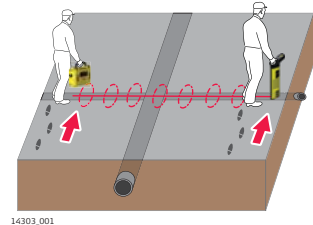

- ☞ Pinpoint and trace utilities until you are satisfied that the area has been adequately tested.

5.4.4 Induction Mode: Radial-Sweep Method

Radial-Sweep method

Use the Radial-Sweep method to discover utilities coming from a known point such as a telecommunications chamber.

- ☞ Two people are required for this process: one for operating the locator and one for operating the transmitter.
- ☞ Set the transmitter and locator to 33 kHz.

1. **Person operating the transmitter:**
Hold the transmitter close to the ground with the arrows on the lid vertical and with the lid facing the person who operates the locator.
- Person operating the locator:**
Position the locator at a minimum distance of 10 m/33 ft away from the transmitter.

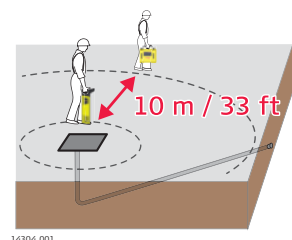

2. **Both persons:**
Start walking parallel to each other, circling the target area.

☞ The tracing signal is induced directly onto the utility and indicated on the locator.

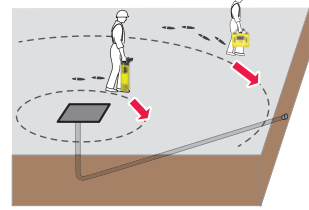

14305.001

3. In the presence of a detectable utility, the locator emits a tone and the signal strength indicators rise and fall as you pass over the utility. Return to the position where the Locate screen shows a peak reading. Mark the position of a utility with marker paint, pegs, flags or something similar.

☞ Never drive pegs into the ground over the utility!

☞ To trace a specific utility, use the pinpointing and tracing methods. Refer to "5.1 How to Pinpoint a Utility" and "5.2 How to Trace a Utility".

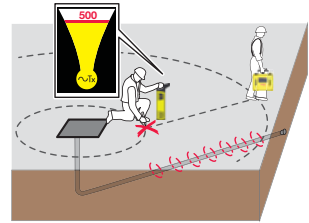

14306.001

☞ Pinpoint and trace utilities until you are satisfied that the area has been adequately tested.

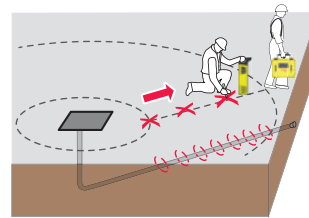

14340.001

5.5

Using the Transmitter in Connection Mode

5.5.1

General Information

Connection mode

Connection mode is the most efficient way to apply a signal to a utility. The cable set of the transmitter or any of the available accessories are connected to the utility which is to be traced or identified.

- ☞ Whenever possible, use the transmitter in connection mode, especially for taking a depth reading.
- ☞ The Numeric Peak Indicator can be used to indicate multiple utilities or to assist tracing. The utility with the maximum value is typically the one connected to.
- ☞ The black connection cable can be connected to other metallic structures which go into the ground, such as iron grids or metal covers of access chambers.
- ☞ In dry conditions it may be necessary to add water around the earth point to get a good connection.
- ☞ When using the connection cable set, examine the connection points and remove contamination if a continuous audible output is not achieved.

- ☞ An extension cable is available to extend either the red or black cables on the connection cable set.
- ☞ Reducing the signal output helps to extend the battery life and to reduce the amount of signal applied to adjacent utilities.

5.5.2

Direct Connection Mode

Using the transmitter in Direct Connection mode

1. Plug the transmitters cable set into the connection socket.



14341_001

2. Ensuring that no utilities are below, push the Earth Pin into the ground and connect the black cable to the Earth Pin.

- ☞ For more safety, we recommend pushing the Earth pin into the ground at an angle of 45 degrees.

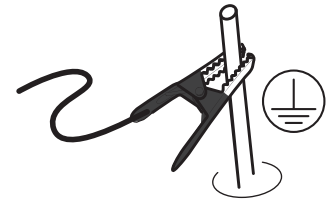

14343_001

- ☞ For best performance, position the Earth pin and black cable at 90 degrees to the suspected direction of the utility.

3. Connect the red cable to the utility.

- ☞ Never connect the red cable directly to an electrical cable!

- ☞ Connecting the red cable to the metal framework of earth-bonded electrical installations such as street lights, pumps or motorised gate housings, improves the detectability of low-loaded electrical cables. For best performance, connect to bare metal.

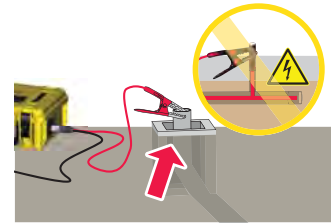

14345_001

- ☞ Using the combination of 33 kHz and 131 kHz frequencies can improve the detectability of small diameter cables or their short runs.

4. Turn on the transmitter.

- ☞ Ensure that the Connection Mode LED indicator is on and the battery level is adequate.

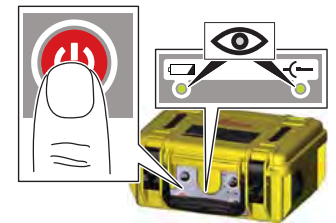

13279_001

5. Select the required frequency and power output.
To indicate that the tracing signal reaches a good level, the Power Output LED indicator and the audible tone change from pulsed to continuous.

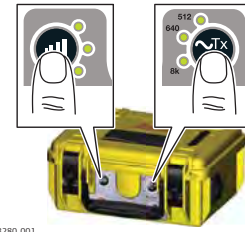

6. Set the locator to Signal Transmitter mode and select the required frequency.



7. At a distance of 5 m (16 ft) to the connection point, circle around the connection point.

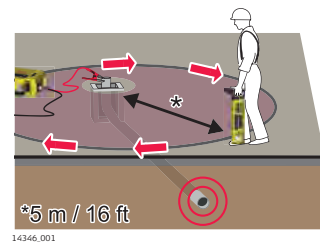

8. In the presence of a detectable utility, the locator emits a tone and the signal strength indicators rise and fall as you pass over the utility. Return to the position where the Locate screen shows a peak reading. Mark the position of a utility with marker paint, pegs, flags or something similar.

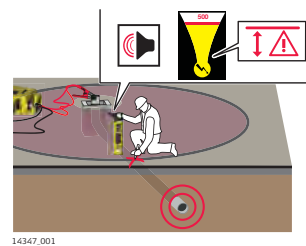

Never drive pegs into the ground over the utility!



To trace a specific utility, use the pinpointing and tracing methods. Refer to "5.1 How to Pinpoint a Utility" and "5.2 How to Trace a Utility".



Pinpoint and trace utilities until you are satisfied that the area has been adequately tested.

5.5.3

Connection Mode: 131 kHz Cable-Wrap Technique

Using the cable-wrap technique

Sometimes it can be difficult to directly connect the transmitter to a utility. In this case, use the cable-wrap technique to apply a signal to a cable.



For this process, the frequency of the transmitter should be set to 131 kHz.

1. Plug the transmitters cable set into the connection socket.



2. Ensuring that no utilities are below, push the Earth Pin into the ground and connect the black cable to the Earth Pin.

☞ For more safety, we recommend pushing the Earth pin into the ground at an angle of 45 degrees.

☞ For best performance, position the Earth pin and black cable at 90 degrees to the suspect direction of the utility.

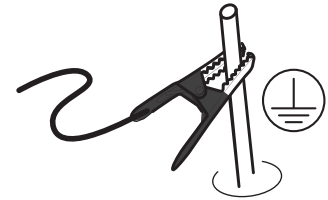

3. Wrap the red cable around the utility.

☞ Never connect the red cable directly to an electrical cable!

☞ To increase performance, increase the amount of wraps.

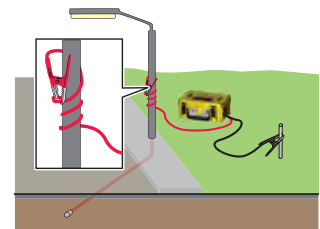

4. Turn on the transmitter.

☞ Ensure that the Connection Mode LED indicator is on and the battery level of the transmitter is adequate.

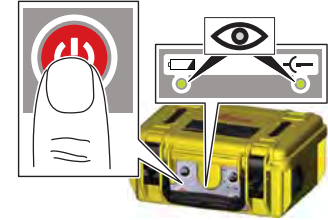

5. Select the required power output level and set the frequency output to 131 kHz. To indicate that the tracing signal reaches a good level, the Power Output LED indicator and the audible tone change from pulsed to continuous.

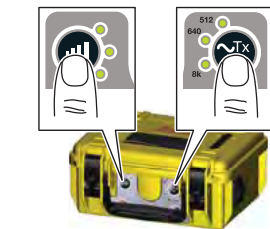

6. Set the locator to Signal Transmitter mode and select the required frequency.



7. At a distance of 5 m (16 ft) to the connection point, circle around the connection point.

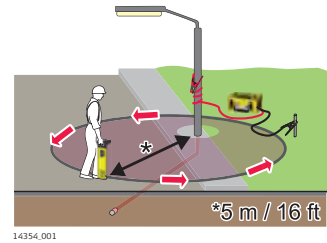

8. In the presence of a detectable utility, the locator emits a tone and the signal strength indicators rise and fall as you pass over the utility. Return to the position where the Locate screen shows a peak reading. Mark the position of a utility with marker paint, pegs, flags or something similar.

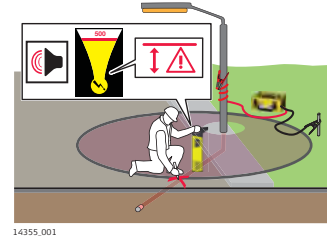

- ☞ Never drive pegs into the ground over the utility!
- ☞ To trace a specific utility, use the pinpointing and tracing methods. Refer to "5.1 How to Pinpoint a Utility" and "5.2 How to Trace a Utility".

☞ Pinpoint and trace utilities until you are satisfied that the area has been adequately tested.

5.6 How to Use the Trace Rod

5.6.1 General Information

Description

The Trace Rod is a utility tracer enabling small diameter non-conductive pipes, ducts, conduit or drains to be traced. It can be used in Line mode to find the route of the duct or Sonde mode to find a blockage.

Description of components

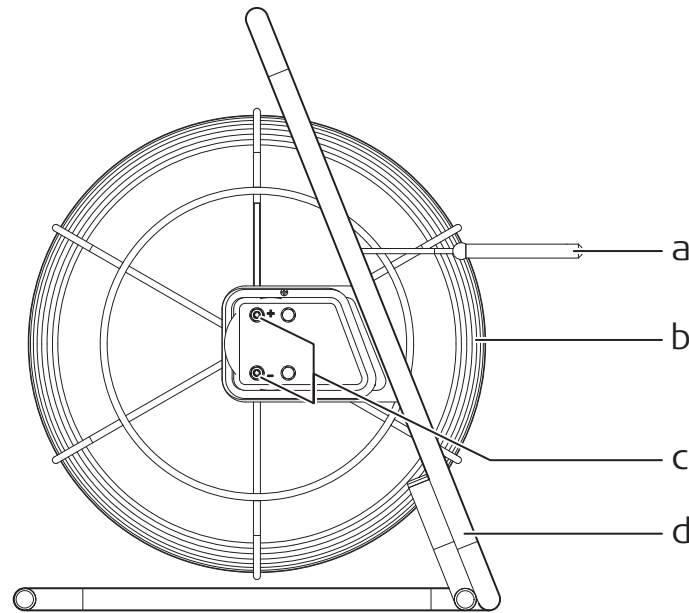

13204.001

- a) **Sonde**
Using Sonde mode, the sonde helps to pinpoint the end point of the trace rod.
- b) **Line**
Flexible, glass-fibre sheathed rod, which incorporates copper wires to conduct the signal.
Using Line mode, the rod helps to trace the route of a utility.
- c) **Connection terminals**
Used to connect to the signal transmitter.
- d) **Frame**
Houses the flexible rod. Can be used in both vertical (as in illustration) and horizontal orientation.

5.6.2

Locating a Utility Using the Trace Rod

Using the trace rod in Line mode

1. Insert the rod into the pipe until the desired length is in place.

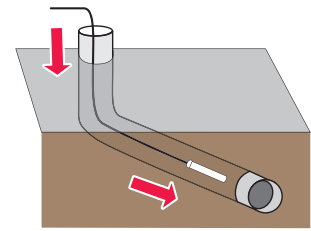

14356.001

2. Plug the transmitters cable set into the connection socket.



14341.001

3. Ensuring that no utilities are below, push the Earth Pin into the ground and connect the black cable to the Earth Pin.



For more safety, we recommend pushing the Earth pin into the ground at an angle of 45 degrees.



For best performance, position the Earth pin and black cable at 90 degrees to the suspect direction of the utility.

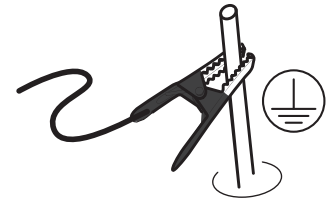

14343.001

4. Connect the red cable to the positive (+) terminal on the trace rod.

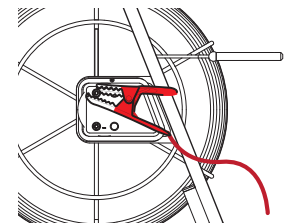

14537.001

5. Turn on the transmitter.
 ☞ Ensure that the Connection Mode LED indicator is on and the battery level of the transmitter is adequate.

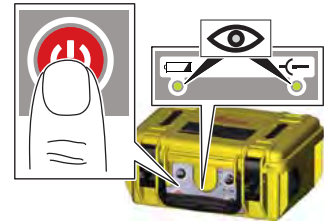

13279.001

6. Select the required frequency and power output.
 To indicate that the tracing signal reaches a good level, the Power Output LED indicator and the audible tone change from pulsed to continuous.

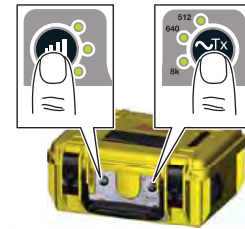

13280.001

7. Set the locator to Signal Transmitter mode and select the required frequency.



13206.001

8. Sweep the area until a signal is detected. Pinpoint and trace the utility.
 ☞ Use the Numeric Peak Indicator to identify the exact position of the rod. The position is typically indicated by the maximum value.

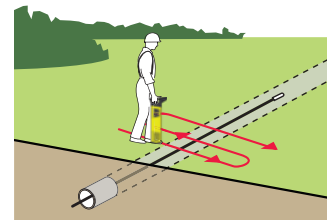

14538.001

Using the trace rod in Sonde mode

- ☞ For ease of use practice the process above ground.
 ☞ For ease and convenience mark the ground every 3 to 4 metres.

1. Insert the rod into the pipe, duct or conduit until the desired length is in place.

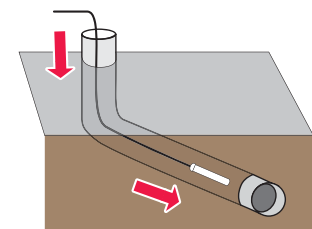

14356.001

2. Plug the transmitters cable set into the connection socket.



14341.001

3. Connect the red cable to the positive (+) terminal on the trace rod. Connect the black cable to the negative (-) terminal.

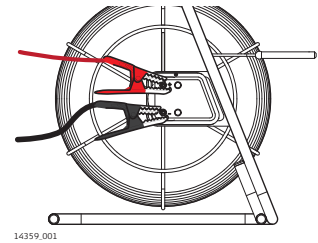

4. Turn on the transmitter.
Ensure that the Connection Mode LED indicator is on and the battery level of the transmitter is adequate.

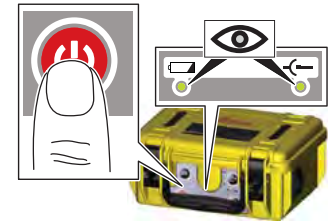

5. Select the required frequency and power output.
To indicate that the tracing signal reaches a good level, the Power Output LED indicator and the audible tone change from pulsed to continuous.

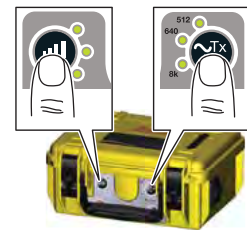

6. Set the locator to Sonde mode and select the required frequency.



7. Walk in line with the suspected direction of travel observing the display. The signal strength indicator rises and falls as you pass over the ghost signal at the back of the sonde, the peak signal directly over the sonde and the ghost signal at the front. The Numeric Peak Indicator displays its highest value when detecting the peak signal.

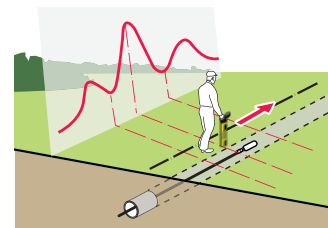

8. Retrace your steps and position the locator directly over the peak signal. Move the locator left and right until the highest numeric reading is obtained. This reading indicates the precise location of the sonde. Pinpoint and trace the utility.

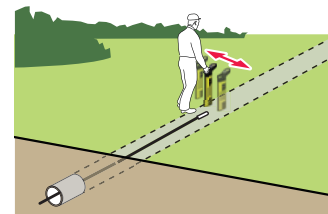

5.7

How to Use the Transmitter Clamps

5.7.1

General Information

Description

A Transmitter Clamp provides a safe technique of applying a signal to utilities such as telecom cables, electric cables, etc. It is connected to the Transmitter and then clipped around the utility. Supply is not interrupted by the applied signal.

Description of components

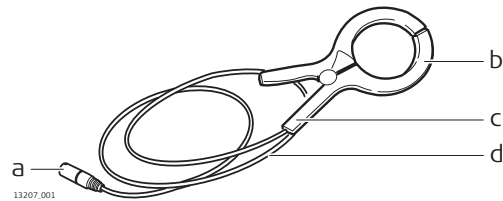

- a) Transmitter plug connector
- b) Jaws
- c) Handle
- d) Cable

5.7.2

Using a Transmitter Clamp to connect to Cable Utilities

Connecting to a cable utility

1. Connect the plug of the transmitter clamp to the transmitter.



2. Open the jaws of the transmitter clamp and place it around the utility to be traced.



Ensure that the jaws are fully engaged.

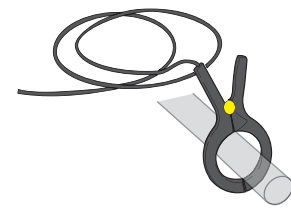

3. Turn on the transmitter.
Ensure that the battery level of the transmitter is adequate.

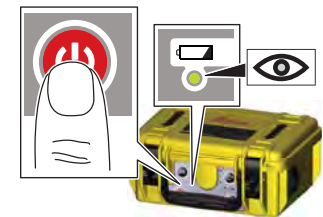

- Select the required frequency and power output.

☞ For compatible frequencies check the type plate of the transmitter clamp.

To indicate that the tracing signal reaches a good level, the Power Output LED indicator and the audible tone change from pulsed to continuous.

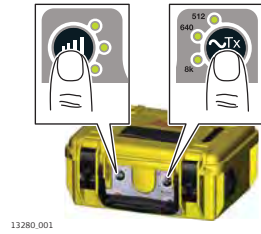

13280.001

- Set the locator to Signal Transmitter mode and select the required frequency.



13206.001

- Trace the route of the utility. Refer to "5.2 How to Trace a Utility".

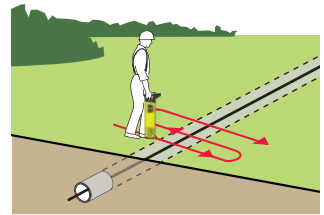

14439.001

5.8

How to Use the Property Plug Connector

5.8.1

General Information

Description

The Property Plug Connector provides a safe technique of applying a traceable signal to live electricity cables. The applied signal does not interrupt mains supply and the risk of serious injury is greatly reduced.

Description of components

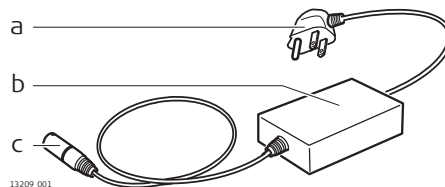

13209.001

- Mains plug connector
- In-line isolator
- Transmitter plug connector

5.8.2

Locating a Utility Using the Property Plug Connector

Using the property plug connector

- Connect the property plug connector to the transmitter.



14342.001

2. Connect the property plug connector to a live mains outlet.

 Ensure that the mains connection is switched on and live.

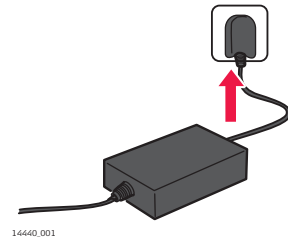

3. Turn on the transmitter.

 Ensure that the battery level of the transmitter is adequate.

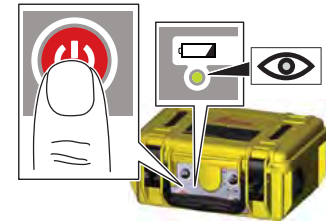

4. Select the required frequency and power output.

 Ensure that the frequency output of the transmitter is comparable to that of the property plug connector. Check the type plate of the property plug connector for the frequency rating.

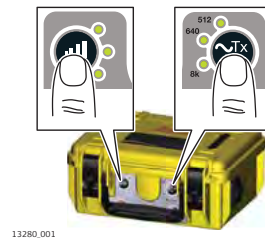

To indicate that the tracing signal reaches a good level, the Power Output LED indicator and the audible tone change from pulsed to continuous.

5. Set the locator to Signal Transmitter mode and select the required frequency.



6. Trace the length of the utility. Refer to "5.2 How to Trace a Utility".

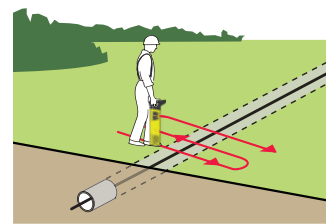

5.9 How to Use the Sondes

5.9.1 General Information

Description

The sondes are signal transmitters used to trace pipes, ducts, conduit or drains. A sonde can be attached to a range of equipment including drain rods, boring tools and inspection cameras. It is powered by its own battery supply,

so unlike other accessories this does not require a connection to the transmitter.

The signal pattern transmitted from a sonde is different to that which is radiated from a utility and requires tracing in its own unique method. The sonde transmits a peak signal over its main body, with a ghost signal at its front and back.

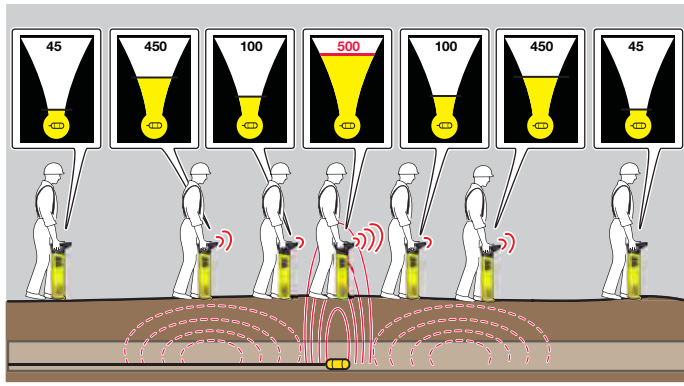

The Locator features a Numeric Peak Indicator which is used to identify the peak reading. Refer to "3.3.2 The Locate Screen".

How to trace a utility using a sonde

- For ease of use practice the process above ground.
- For ease and convenience mark the ground every 3 to 4 metres.

1. Set the locator and sonde to the same frequency and verify their performance.



13208_001

2. Once the function of the sonde has been verified, connect it to drain rods or other means of guiding it. Insert the sonde into the pipe, duct, conduit or drain.

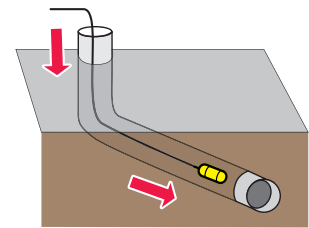

14441_001

3. Walk in line with the suspected direction of travel observing the display. The signal strength indicator rises and falls as you pass over the ghost signal at the back of the sonde, the peak signal over the sonde and the ghost signal at the front. The Numeric Peak Indicator displays its highest value when detecting the peak signal.

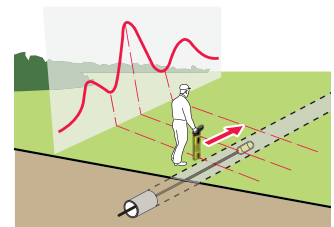

14442_001

4. Retrace your steps and position the locator directly over the peak signal. Move the locator left and right until the highest numeric reading is obtained. This reading indicates the location of the sonde.

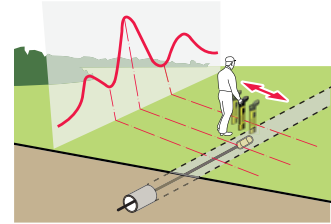

14443.001

6

Estimating Depth and Current of a Utility

6.1

Utility Line Depth

Taking a depth reading

For utility line depth, the locator needs to be used in conjunction with a signal transmitter. Refer to "5.4 Using the Transmitter in Induction Mode" and 5.5 Using the Transmitter in Connection Mode.

1. Set the locator to Transmitter mode and select the required frequency.

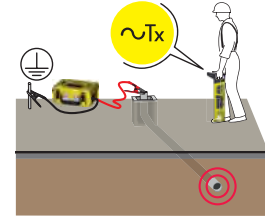

14461_001

2. Position the locator directly over and at 90° to the direction of the utility.

Ensure that the locator foot is directly on the ground.

Hold the locator upright and take care not to move it.

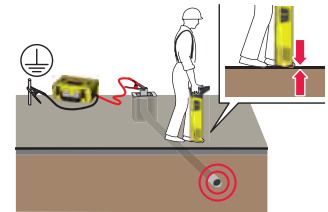

14462_001

3. Press and release the Depth Estimation key.

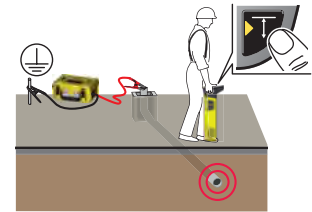

14463_001

4. The Line Depth screen displays the measured depth.
Model-specific option: The measured current (mA) is displayed below the measured depth.

Lift the locator off the ground by approximately 15 cm/6 in and take a second depth reading. This depth reading should confirm the added height.

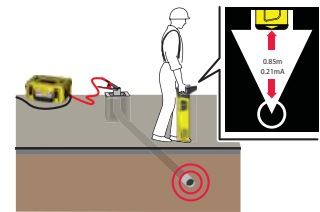

14464_001

5. The depth is calculated as distance to the centre of the utility! Allowances should be taken into account.

Note the difference between a and b!

- a) Actual depth of the utility.
- b) Displayed depth reading: Depth to the centre of the utility.

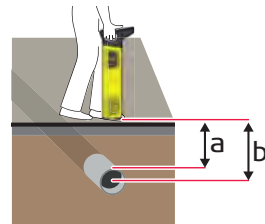



14465_001

6.2

Sonde Depth

Taking a depth reading

-  For sonde depth, the locator needs to be used in conjunction with a sonde. Refer to "5.9 How to Use the Sondes".
1. Set the locator to Sonde mode and select the required frequency.



13208.001
 2. Position the locator directly over and in line with the sonde.

 Ensure that the locator foot is directly on the ground.

 Hold the locator upright and take care not to move it.

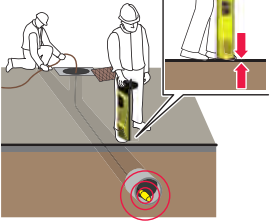

14666.001
 3. Press and release the Depth Estimation key.

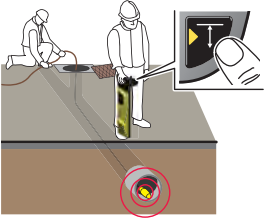

14667.001
 4. The Sonde Depth screen displays the measured depth.

 Lift the locator off the ground by approximately 15 cm/6 in and take a second depth reading. This depth reading should confirm the added height.

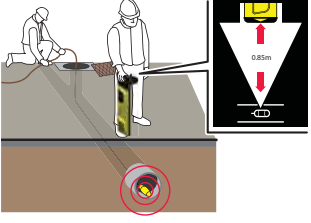

14668.001
 5. The depth is calculated as distance to the sonde within the pipe or duct! Take into account allowances for the diameter of the pipe or duct.

Note the difference between a and b!

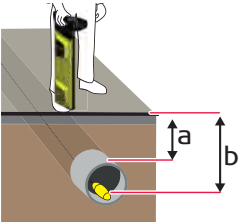
 - a) Actual depth of the utility.
 - b) Displayed depth reading: Depth to the sonde.

14669.001

6.3

Depth Code Information

Depth Code Screens

-  If it is not possible to take a depth reading, a depth code screen is displayed. Refer to "3.3.3 The Depth Estimation Screens": "Depth out of range" and "Signal out of range".

6.4

Utility Current Measurement

Current measurement to identify utilities

- ☞ Model-specific option.
- ☞ The Current measurement is measured in mA (milliamperere) and is displayed with the utility line depth. Refer to "6.1 Utility Line Depth".

Identifying a utility

The signal transmitter is used to apply a signal (current) to the utility to be traced. The signal can couple onto additional utilities making it difficult to distinguish by conventional locating techniques.

Current measurement helps to identify the utility to which the transmitter is attached by providing the highest current reading (mA). Unlike the Numeric Peak reading, the current reading is not effected by changing depth levels.

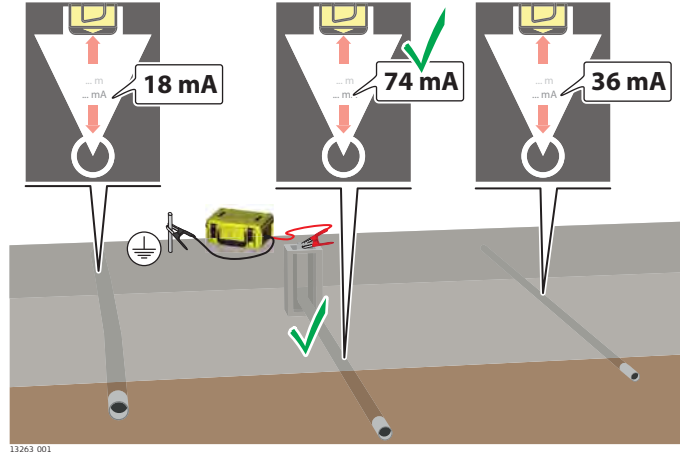

Identifying the utility layout and condition

The signal (current) applied by the transmitter decreases at a uniform rate as it travels along the utility. This can help to identify the utility layout and condition.

A sudden reduction in current may indicate a fault in the utility, a damage to the insulation, or a connection off the utility.

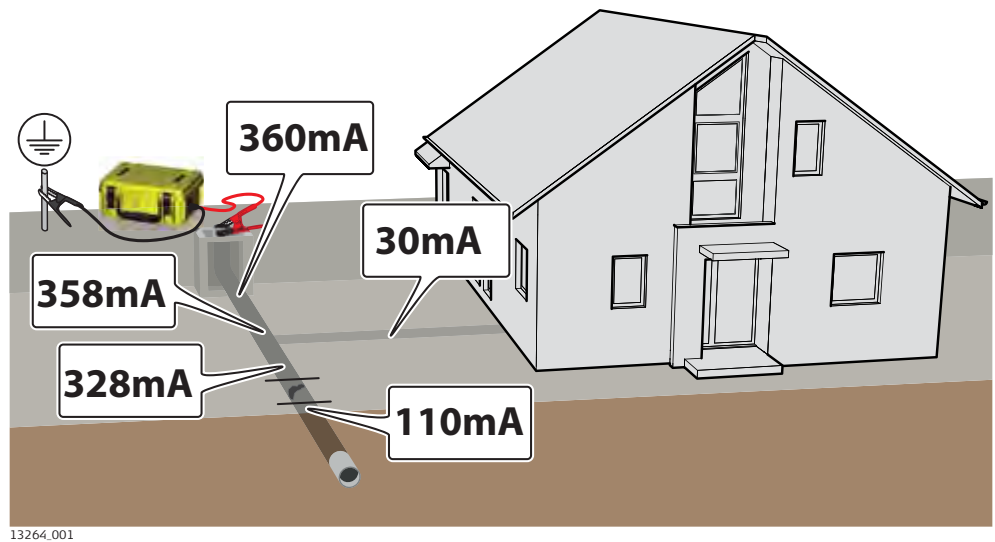

7

Connectivity

7.1

Locator Bluetooth Connectivity

Connecting the locator using Bluetooth

Model-specific option:







The locator is provided with Bluetooth connectivity.

Bluetooth status

The Bluetooth status is indicated on the status bar of the Locate screen. Refer to "Status bar icons" (within "3.3.2 The Locate Screen").

Colour of Bluetooth Icon	Status
White	Connection available
Green	Connection available and active
Red	Fault

Important information for pairing:

-  The locator must be turned on and have the Bluetooth enabled throughout the pairing process.
-  The locator identification is model type and serial number, for example DD230-000001.
-  For guidance on establishing a connection, follow the instructions on the external device or software. Refer to the manufacturer's instructions.
-  When paired and following a depth reading, the locator will display a Bluetooth symbol within the depth screen. To transfer the information to the data logger press the depth button whilst the Bluetooth symbol is displayed.
-  Whilst the locator is calculating depth the data output stops.
-  If there is no wireless communication then the Bluetooth symbol will not be displayed and the unit will function as a locator.
-  The output format is ASCII.

Output options

In the submenu **Communication**, select the required Bluetooth option. Refer to "Submenu Communication" (within "3.4.2 Menu Options").

Output strings

- **DD SMART:**
DPxxxxUMxMDxUTxMAxxxxxNPxxxPIxxDVxxxSNxxxxxxBTxCMxx DTxxxxxxx
DP0.75UMMMD3UTLMA10.20NP450PIODV230SN123456BT9CM12DT01/01/17
- **BT1** option:
DVxxxSNxxxxxSVxxxxTMxxxxDTdd/mm/yyCMxxSTxBTxMDxSSxxUMxDPxxxx
DV550SN12345SV3.01TM08:30DT01/12/10CM12ST0BT7MD3SS16UMMDP125
- **BT2** option:
DPxxxxUMxMDxSSxxDVxxxSNxxxxxCMxxBTxSTxSVxxxxDTxxxxxxxTMxxxx
DP125UMMMD3SS16DV550SN12345CM12BT7ST0SV3.01DT01/12/10TM08:30

Data Output	Range	Example Value	Description
DV	000 to 999	230	Model identifier
SN	000000 to 999999	123456	Serial number
SV	0.00 to 9.99	3.01	Software version
TM	00:00 to 23:59	08:30	Time hh:mm Default = 00:00; no RTC fitted
DT	00/00/00 to 31/12/99	01/12/10	Date dd/mm/yy
CM	00 to 12	12	Number of months until next calibration (00 to 12)
ST	0 or 1	0	Health test: 0 = Passed 1 = Fail
BT	0 to 9	7	Battery level: 0 = Empty 9 = Fully charged
MD	0 to 9	3	Mode: 0 = Power 1 = Radio 2 = Passive Auto 3 = Transmitter Auto 4 = 33 kHz & 131 kHz 5 = 131 kHz 6 = 33 kHz 7 = 8 kHz 8 = 640 Hz 9 = 512 Hz
SS	00 to 75	16	Signal strength: 00 to 75
UM	M or I	M	Units of measurement: Metric or Decimal Feet
DP	0.10 to 9.99 Model dependent	1.25	Depth value displayed depends on value for UM.
UT	L or S	L	Utility type: Line or Sonde
MA	0 to 99.99	1.10	Current measurement displayed in mA
NP	0 to 999	450	Numeric Peak value displayed on the locator
PI	1 to 9	1	Point of Interest: number defines colour of selected marker. x = off

7.2

Locator USB Connectivity

Connecting the locator using USB

The locator is provided with a micro USB port and can be connected to a PC for one of the following reasons:

- To update software.
- To provide calibration and maintenance support.
- To configure the product.
- To upload data to the PC (if the locator is provided with memory function).

 It is recommended that a battery level of greater than 50% is maintained whilst in communication with external devices.

USB status

The USB status is indicated on the status bar of the Locate screen. Refer to "Status bar icons" (within "3.3.2 The Locate Screen").

Colour of USB Icon	Status
White	Connection available
Green	Connection available and active
Red	Fault

Access to the USB port

 To maintain environmental protection open and use the USB port only in dry conditions. Always reinstate the cover after use.

1. Unscrew the fastening screws of the cover and open it.

 For guidance on establishing a connection, follow the instructions on the external device or software. Refer to the manufacturer's instructions.



14470.001

2. After disconnection, reinsert the cover and tighten the fastening screws.



14471.001

7.3

Transmitter USB Connectivity

Connecting the transmitter using USB

The signal transmitter is provided with a USB port and can be connected to a PC for one of the following reasons:

- To update software.
- To provide calibration and maintenance support.

 It is recommended that a battery level of greater than 50% is maintained whilst in communication with external devices.

Access to the USB port

-  The cover of the battery compartment also serves as cover for the USB port. To maintain environmental protection open the cover only in dry conditions. Always close the cover of the battery compartment after use.
-

1. Unscrew the fastener of the cover.



14472_001

2. Lift the cover of the battery compartment to access the USB port.

-  For guidance on establishing a connection, follow the instructions on the external device or software. Refer to the manufacturer's instructions.



14474_001

3. After disconnection, close the cover of the battery compartment and tighten the fastener.



14473_001

8 Locator Memory and GPS

8.1 Internal Memory

Record and store information with the locator



The internal memory is a model-specific option.

The internal memory allows you to record and store information while using the locator. After completing the initial start-up routine, information is recorded every second. These records (logs) are stored in the internal memory and can be retrieved and transferred through Bluetooth or USB connection for analysis.



The records are sequentially stored. Once the internal memory is full, the oldest records are overwritten.



To transfer records from the worksite, use the transfer app and Bluetooth connectivity.



Refer to the Leica Geosystems website for the latest information on mobile Apps and analysis software.

8.2 Internal GPS

Record the geographical position of the locator



The internal GPS module is a model-specific option.

The internal GPS module allows you to record the geographical position while using the locator. The geographical position (Latitude and Longitude) is stored in the internal memory and provides information on where the locator was used.

GPS status

The GPS status is indicated on the status bar of the Locate screen. Refer to "Status bar icons" (within "3.3.2 The Locate Screen").

Colour of GPS Icon	Status
White	Connection available
Green	Connection available and GPS position found
Red	Fault



As part of the start-up routine, a GPS search mode is activated allowing the internal GPS module time to search for the GPS position. The search mode stays active even if the locator is turned off. The search mode stops when a GPS position is found or when the search period of 12 minutes has elapsed.



The GPS search mode does not affect the performance of the locator. The locator can be used as normal while the search mode is active.

8.3 Point of Interest

Record a point of interest



This function requires a locator model with internal GPS module and internal memory.

Locators with an internal GPS module allow you to record a Point of Interest (POI) and store it in the internal memory. Use the Point-of-Interest function to highlight worksite features of particular interest, such as the position of a utility or the location of an access chamber.



The Point-of-Interest function can be used in all search modes.

1. Select  from the main menu.

2. Select  to adjust the Point-of-Interest setting.

3.
 - Select a marker in the desired colour to activate the POI function.
The activated POI status is indicated on the status bar of the Locate screen. Refer to "Status bar icons" (within "3.3.2 The Locate Screen").
 - Select  to turn off the POI function.

4. To record a Point of Interest, press and release the Depth Estimation key.



When a GPS position is available, the POI information is recorded and stored in the internal memory.

Available POI markers

Depending on the colour, the following numbers are recorded to the internal memory:

Blue	Brown	Green	Grey	Orange	Purple	Red	White	Yellow
1	2	3	4	5	6	7	8	9

9

Batteries



Use the locators and transmitters with an authorised rechargeable Li-Ion battery pack.

9.1

Operating Principles

First-time use/ charging batteries

- The battery must be charged before using it for the first time because it is delivered with an energy content as low as possible.
- The permissible temperature range for charging is from 0 °C to +40 °C/ +32 °F to +104 °F. For optimal charging, we recommend charging the batteries at a low ambient temperature of +10 °C to +20 °C/+50 °F to +68 °F if possible.
- It is normal for the battery to become warm during charging. Using the chargers recommended by Leica Geosystems, it is not possible to charge the battery once the temperature is too high.
- For new batteries or batteries that have been stored for a long time (> three months), it is effectual to make only one charge/discharge cycle.
- For Li-Ion batteries, a single discharging and charging cycle is sufficient. We recommend carrying out the process when the battery capacity indicated on the charger or on a Leica Geosystems product deviates significantly from the actual battery capacity available.

Operation/ discharging

- The batteries can be operated from -20 °C to +55 °C/-4 °F to +131 °F.
- Low operating temperatures reduce the capacity that can be drawn; high operating temperatures reduce the service life of the battery.

9.2

Charging the Li-Ion Battery Pack

WARNING

Short circuit of battery terminals

If battery terminals are short circuited e.g. by coming in contact with jewellery, keys, metallised paper or other metals, the battery can overheat and cause injury or fire, for example by storing or transporting in pockets.

Precautions:

- ▶ Make sure that the battery terminals do not come into contact with metallic objects.

Charging the battery pack of the locator



If the batteries of the locator are low and need to be recharged, the status bar icon for the battery condition changes to red.

1. Rotate and disengage the clips of the battery compartment.



14481_001

2. Lift the cover of the battery compartment and remove the Li-Ion battery pack.



3. Connect the charger plug into the charge jack on the battery pack.



4. Plug the connector into a suitable power source.



The small LED next to the charge jack flashes to indicate that the battery pack is charging. When the battery pack is fully charged the LED is on solid.

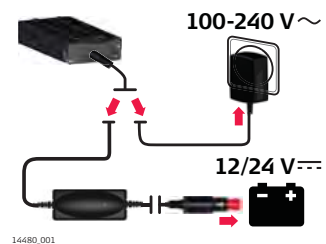

5. When the battery pack is fully charged, disconnect the charger and reinsert the battery pack into the battery compartment.



6. Close the battery compartment and secure the clips.



Charging the battery pack of the signal transmitter



If the battery pack of the signal transmitter is low and needs to be recharged, the Low Battery LED indicator illuminates red.



The cover of the battery compartment also serves as cover for the USB port. To maintain environmental protection open the cover only in dry conditions. Always close the cover of the battery compartment after use.

1. Unscrew the fastener of the battery cover.



14472.001

2. Lift the cover of the battery compartment and remove the Li-Ion battery pack.



14475.001

3. Connect the charger plug into the charge jack on the battery pack.



14479.001

4. Plug the connector into a suitable power source.



The small LED next to the charge jack flashes to indicate that the battery pack is charging. When the battery pack is fully charged the LED is on solid.

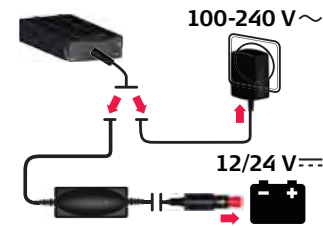

14480.001

5. When the battery pack is fully charged, disconnect the charger and reinsert the battery pack into the battery compartment.



14476.001

6. Close the cover of the battery compartment and tighten the fastener.



14473.001

10

Functional Checks

10.1

Locator Health Check

Checking the function

Leica Geosystems accepts no responsibility for maintenance and calibration conducted by unauthorised persons. It is vital to check the status of the unit, its basic functionality and batteries before Calibration Verification is used.

1. **Inspect the general condition of the locator.**

- The casing should be free of significant damage and maintain the products environmental rating against water and dust ingress.
- Switches and control devices must be free of defect.
- Labels must be legible and intact, any display or membrane label must be free of damage and tears.
- The cover of the battery compartment must lock into place.
- All the battery contacts and springs of the compartment must be free of corrosion and the compartment in good condition.
- The batteries must be charged in excess of 50%.
- The cover of the USB port must be in place and provide the required environmental protection against water and dust ingress.

2. **Once the general condition of the locator is established, perform the Audio/Visual test.**

Turn on the locator. The display must illuminate with a splash screen followed by the Locate screen. The locator should emit a tone.



Checking the performance

The purpose of the following procedure is to verify the performance of the locator.

 Conduct the test away from areas of electromagnetic interference or over buried utilities with a large signal radiating off them.

1. Turn on the locator.

2. Press and hold the Menu key to display the Locator main menu.

 When displaying the main menu, the option **Health Check** is highlighted by default. 

3. Press and release the Menu key to perform a Health Check.

4. Observe the displayed output.

 The locator is within the set tolerances.

 The locator is outside the set tolerances and may need servicing.

 The electrical noise level is too high to start the test. Repeat the test in a different location.

 If the Health Check fails, the locator automatically repeats it. Repeated failure indicates a faulty unit. Return the locator for service.

Locator depth test

 To carry out this test, the depth of the test utility must be known.

1. Connect and apply a traceable signal to the test utility. Refer to "5.5.2 Direct Connection Mode".

2. Turn on the locator and perform a depth reading. Refer to "6.1 Utility Line Depth".



If the depth reading deviates from known depth of the test utility or if an error code is displayed, return the locator for service.

10.2

Calibration Verification

Purpose of calibration verification

Calibration Verification provides an over the internet verification of key circuit components and calibration settings. The current status is verified against settings established during original manufacture test and calibration.

Upon a successful verification, a Calibration Certificate is provided and the products calibration maintenance dates are updated, units outside of tolerance should be returned to an approved service centre.

Checking the function

Leica Geosystems accepts no responsibility for maintenance and calibration conducted by unauthorised persons. It is vital to check the status of the unit, its basic functionality and batteries before Calibration Verification is used.

1. **Inspect the general condition of the locator.**

- The casing should be free of significant damage and maintain the products environmental rating against water and dust ingress.
 - Switches and control devices must be free of defect.
 - Labels must be legible and intact, any display or membrane label must be free of damage and tears.
 - The cover of the battery compartment must lock into place.
 - All the battery contacts and springs of the compartment must be free of corrosion and the compartment in good condition.
 - The batteries must be charged in excess of 50%.
 - The cover of the USB port must be in place and provide the required environmental protection against water and dust ingress.
-

2. **Once the general condition of the locator is established, perform the Audio/Visual test.**

Turn on the locator. The display must illuminate with a splash screen followed by the Locate screen. The locator should emit a tone.

1. Connect to DX Office Shield via USB. Refer to 7.2 Locator USB Connectivity and 7.3 Transmitter USB Connectivity.



2. Purchase and activate Calibration Verification from the CalMaster tab. A user login will be required. Full instructions are provided in DX Office Shield.

3. After testing remove USB Cables and secure the USB cover in place.



Checking the performance

The purpose of the following procedure is to verify the performance of the locator.

- ☞ Conduct the test away from areas of electromagnetic interference or over buried utilities with a large signal radiating off them.

1. Turn on the locator.
2. Press and hold the Menu key to display the Locator main menu. The option **Health Check** is highlighted by default. 🏠
3. Press and release the Menu key to activate the **Health Check**.
4. Observe the displayed output.
 - ✓ The locator is within the set tolerances.
 - ✗ The locator is outside the set tolerances and may need servicing.
 - ⊘ The electrical noise level is too high to start the test. Repeat the test in a different location.

- ☞ If the **Health Check** fails, the locator automatically repeats it. Repeated failure indicates a faulty unit. Return the locator for service.

10.3

Locator Fault Codes

Fault codes and troubleshooting

If the locator detects a fault, a notification is displayed on the startup screen or within the status bar.

To display the locators fault code, access the Alerts menu and select this option: .

Refer to "Submenu Alerts" within "3.4.2 Menu Options".

Fault Code	Fault Area	Explanation and Recommended Action
F00	Product test	<ul style="list-style-type: none">• Activate the product test away from potential sources of electrical interference. For product testing, refer to "10.1 Locator Health Check".• If fault persists, return to service partner.
F20	Communication	Fault with external communications such as Bluetooth, GPS or USB connection. <ul style="list-style-type: none">• Refer to "7 Connectivity".• If fault persists, return to service partner.
F40	Hardware Fault	Fault with electronic hardware, e.g. memory, motion sensor or time clock. If fault persists, return to service partner.
F60	Aerial Fault	Return to service partner for diagnosis and repair.

10.4

Functional Check of the Transmitter

Checking the function

Before you carry out any tests, it is vital to check the status of the unit, its batteries and its basic functionality. To achieve this, carry out the following procedure:



For this procedure, the cable set of the transmitter and a fully charged battery pack are required.

- 1. Inspect the general condition of the transmitter.**
 - The casing should be free of significant damage.
 - The cable set should be free of damage to the cable insulation and clip shrouds. The clips should be free of corrosion.
 - Body labels must be legible and intact.
 - The cover of the battery compartment must lock into place.
 - All the battery contacts and springs of the compartment must be free of corrosion and the compartment in good condition.
 - The battery contacts must be free of corrosion.
 - The cover of the USB port must be in place and provide the required environmental protection.
- 2. Once the general condition of the transmitter is established, perform the Audio/Visual test.**

Turn on the transmitter. All LED indicators should light up and the speaker should emit a tone.

Checking the performance

3. Perform a Battery check.

Observe the Low Battery LED indicator and replace or recharge the batteries if necessary.

The purpose of the following procedure is to verify the performance of the transmitter.

 Conduct the test away from areas of electromagnetic interference or over buried utilities with a large signal radiating off them.

-
1. Plug the transmitters cable set into the connection socket.
 2. Connect the black and red cable clips together, ensuring good metal to metal contact.
 3. Press and hold the Frequency key and turn on the transmitter. Keep holding the Frequency key until the test starts.
 4. Observe the displayed output during the performance check:
Induction Mode Test: The Frequency LED indicators light up one after the other, showing the frequency on test.
Connection Mode Test: The Connection Mode LED indicator lights up. The Frequency LED indicators light up, showing the frequencies on test. The Connection Mode LED indicator turns off.
 5. After the performance check, the transmitter displays the result:
Test successful: A high-low pulsed tone is emitted three times. If the test was done with low batteries, the Low Battery LED indicator illuminates.
Test failed: A low-pitched tone is emitted. If the test was done with low batteries, the Low Battery LED indicator illuminates.
 - If the Induction Mode failed: The respective Frequency LED indicator lights up.
 - If the Connection Mode failed: The Connection Mode LED indicator and the respective Frequency LED indicator light up.

 If the performance check fails, ensure that the cable set of the transmitter is fully engaged and the clips are connected.

 If the performance check fails, the transmitter automatically repeats it. Repeated failure indicates a faulty unit. Return the transmitter for service.

 The Signal Transmitters firmware can be updated to the latest standard using DX Office Shield. It is important that DX Office Shield is installed on a PC with Internet access.

10.5

Checking the performance

Functional Check of the Trace Rod

The purpose of the following procedure is to verify the performance of the trace rod.

 For this procedure, the following system components are required:

- A transmitter for generating the signal in the Sonde and Line mode tests.
- The cable set for the transmitter.

-
1. Plug the transmitters cable set into the connection socket.
 2. Connect the red cable to the positive (+) terminal on the trace rod and the black cable to the negative (-) terminal.
-

3. Turn on the transmitter.
 4. Use the Power Output key on the transmitter to adjust the power output to minimum.
The transmitter should emit a constant tone.
 5. Disconnect the black cable from the negative (-) terminal.
The transmitter should emit a pulsed tone.
- ☞ If for any of these tests no output or a significantly different output is displayed, return the trace rod for service.

10.6

Functional Check of the Sonde

Checking the function

Before you carry out any tests, it is vital to check the status of the unit, its batteries and its basic functionality. To achieve this, carry out the following procedure:

1. **Inspect the general condition of the sonde.**
 - The casing should be free of significant damage.
 - The sealing ring and the screw thread should be intact.
2. **Once the general condition of the sonde is established, perform the LED test.**
Turn on the sonde. The LED indicator should light up.
3. **Perform a Battery check.**
If the LED indicator lights up faintly or if the sonde does not transmit a signal, the batteries are probably low. Replace the batteries if necessary.

Checking the performance

The purpose of the following procedure is to verify the performance of the sonde.

- ☞ For this procedure, the following system components are required:
- A locator to detect the signal of the sonde.
 - A work area free of utilities (as illustrated).

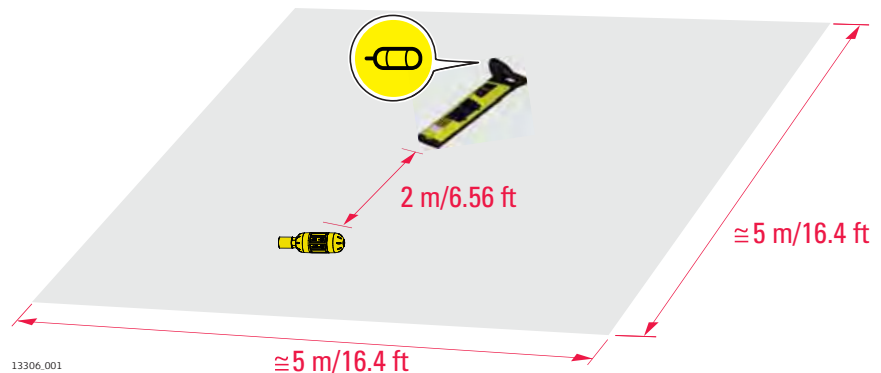

1. Set up the sonde for use at 33 kHz.
2. Turn on the locator. Set the locator to 33 kHz Sonde mode.
3. Aim the locator foot at the sonde.
☞ At a distance of 2 m / 6.56 ft, the signal strength indicators should display a peak reading.
4. Set up the sonde for use at 8 kHz.
5. Turn on the locator. Set the locator to 8 kHz Sonde mode.

6. Aim the locator foot at the sonde.



At a distance of 2 m/6.56 ft, the signal strength indicators should display a peak reading.



If for any of these tests no output or a significantly different output is displayed, return the sonde for service.

11 Care and Transport

11.1 Transport

Transport in the field When transporting the equipment in the field, always make sure that you carry the product in its original packaging or equivalent, and protect the equipment against shock and vibration.

Transport in a road vehicle Never carry the product loose in a road vehicle, as it can be affected by shock and vibration. Always carry the product in its container and secure it.
For products for which no container is available use the original packaging or its equivalent.

Shipping When transporting the product by rail, air or sea, always use the complete original Leica Geosystems packaging, container and cardboard box, or its equivalent, to protect against shock and vibration.

Shipping, transport of batteries When transporting or shipping batteries, the person responsible for the product must ensure that the applicable national and international rules and regulations are observed. Before transportation or shipping, contact your local passenger or freight transport company.

11.2 Storage

Product Respect the temperature limits when storing the equipment, particularly in summer if the equipment is inside a vehicle. Refer to "12 Technical Data" for information about temperature limits.

Storing Long-term battery storage is not recommended. If storage is necessary:

- Refer to "Technical Data" for information about storage temperature range.
- Remove batteries from the product and the charger before storing.
- After storage recharge batteries before using.
- Protect batteries from damp and wetness. Wet or damp batteries must be dried before storing or use.
- A storage temperature range of 0°C to +30°C/+32°F to 86°F in a dry environment is recommended to minimise self-discharging of the battery.
- At the recommended storage temperature range, batteries containing a 40% to 50% charge can be stored for up to one year. After this storage period the batteries must be recharged.
- Always try to use a 'first-in first-out' approach to minimise storage time.

11.3 Cleaning and Drying

Damp products Dry the product, the transport container, the foam inserts and the accessories at a temperature not greater than 40°C/104°F and clean them. Do not repack until everything is dry. Always close the transport container when using in the field.

Cables and plugs Keep plugs clean and dry. Blow away any dirt lodged in the plugs of the connecting cables.

12

Technical Data

12.1

Conformity to National Regulations

Conformity to national regulations

- For products without radio transmitter or receiver:
- FCC Part 15 (applicable in US)



- Hereby, Leica Geosystems AG declares that the product/s is/are in compliance with the essential requirements and other relevant provisions of the applicable European Directives.
The full text of the EU declaration of conformity is available at the following Internet address:

Conformity to national regulations

- FCC Part 15 (applicable in US)
- Hereby, Leica Geosystems AG declares that the radio equipment type DD120/DD130/DD220/DD230 is in compliance with Directive 2014/53/EU and other applicable European Directives.



- Class 1 equipment according to European Directive 2014/53/EU (RED) can be placed on the market and be put into service without restrictions in any EEA member state.
- The conformity for countries with other national regulations not covered by the FCC part 15 or European Directive 2014/53/EU has to be approved prior to use and operation.

12.2

Transmitter Technical Data

DA series signal transmitters

Mode	Output
Induction	Up to 1 Watt max.
Connection mode	Model dependent, up to 1 Watt or 3 Watt, when connected to a buried utility with an impedance of 300 Ohms
Operating transmission frequencies	131.072 (131) kHz 32.768 (33) kHz 8.192 (8) kHz 512 Hz (DA230 series models) 640 Hz (DA230 series models)
Display panel	LED Indicators: Battery low indicator Connection mode Frequency indicator Power Output indicator
Keypad	4 membrane push buttons

Mode	Output
Audio	85 dBA @ 30 cm Induction mode: Pulsed output with a differing rate for each frequency Connection mode: Low - No output: pulsed output, differing rate for each frequency Good Connection output: constant tone, pitch dependent on power output
Battery type	7.4 V Li-Ion pack
Typical operating time 3 Watt, 1 Watt	15 hours at power level 2 connection mode
Dimensions	250 x 206 x 113 mm/9.84 x 8.11 x 4.45 inches
Weight (incl. standard accessories and batteries)	2.38 kg with Li-Ion
Temperature	Operating -20°C to +50°C, -4°F to +122°F Storage -40°C to +70°C, -40°F to +158°F
Protection against water, dust and sand	Conforms to IP67 lid open or closed
Humidity	95% RH non condensing The effects of condensation are to be effectively counteracted by periodically drying out the product.
Approvals	CE, FCC

Dimensions

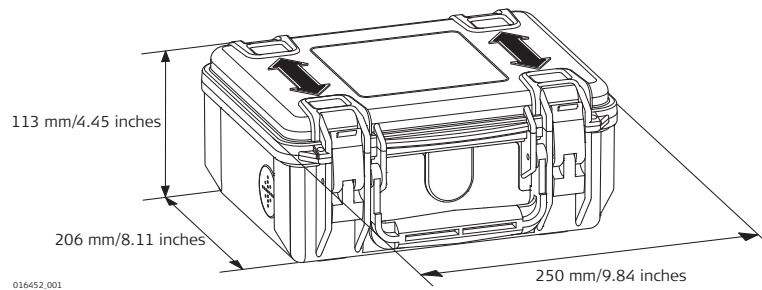

12.3

DD220/DD230 locators

Locator Technical Data

Operating frequencies

Mode	Frequency	Sensitivity @ 1 meter
Power	50 Hz / 60 Hz mains electrical and harmonics	3 mA
Radio	15 kHz to 60 kHz	25 µA
Auto	Power, Radio, 33 kHz	Mode dependent

Mode	Frequency	Sensitivity @ 1 meter
Transmitter	131.072 (131) kHz	5uA
	32.768 (33) kHz	5uA in
	8.192 (8) kHz	100uA
	512 Hz (DD230 series models)	500uA
	640 Hz (DD230 series models)	500uA

Depth estimation

Locator	DD220 series	DD230 series
Depth range	Line 0.1m to 5m	Line 0.1m to 7m
	Sonde 0.1m to 7m	Sonde 0.1 to 10m
Depth accuracy Undistorted signal	5%	5%

General technical data

Mode	Output
Display panel	Colour LCD
Keypad	3 membrane push buttons
Audio	85 dBA @ 30 cm Power, Radio, Auto Differing Tone for each mode Transmitter Modes Same tone
Battery type	7.4 V Li-Ion pack
Typical operating time	15 hours constant use at 20°C/68°F
Dimensions	93 x 290 x 765 mm/3.66 x 11.42 x 30.12 inches
Weight (incl. batteries)	2.7 kg with Li-ion
Temperature	Operating -20°C to +50°C, -4°F to +122°F Storage -40°C to +70°C, -40°F to +158°F
Protection against water, dust and sand	Conforms to IP66
Humidity	95% RH non condensing The effects of condensation are to be effectively counteracted by periodically drying out the product.

Dimensions

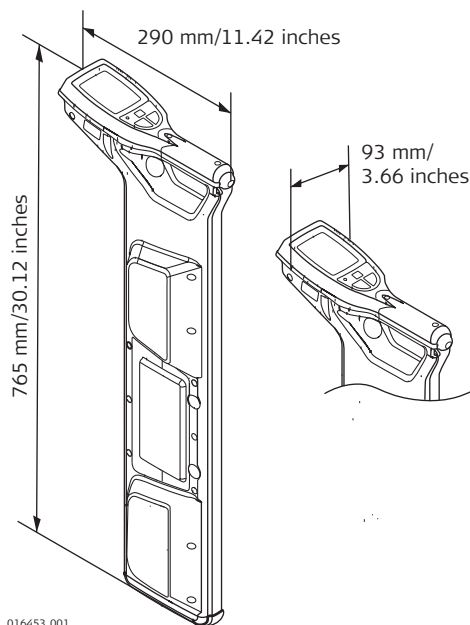

Smart locators

Component	Value
Bluetooth	Class 2 BLE dual mode module <ul style="list-style-type: none"> • Bluetooth Classic 2.1 • Bluetooth 4.0 (LE)
Memory	8 GB internal memory
GPS	Chipset (1) : u-blox®GPS <ul style="list-style-type: none"> • Receiver Type: GPS L1C/A, SBAS L1C/A, QZSS L1C/A, GLONASS L1OF, BeiDou B1 • Accuracy (2): Horizontal Position 2.5 m Autonomous, 2.0 m SBAS, CEP • Start time: Cold 45 s typical, Aided 7 s typical, Hot 1 s typical

(1) All data/information according to manufacturer u-blox®GPS; Leica Geosystems does not assume any liability whatsoever for such information.

(2) Accuracy is dependent upon various factors including atmospheric conditions, multipath, obstructions, signal geometry and number of tracked satellites.

Charger

Description	A100 Lithium Ion Charger	A140 Lithium Ion Charger
Type	Li-Ion battery charger	Li-Ion battery charger
Input voltage	100 V AC-240 V AC, 50 Hz-60 Hz	12 V DC
Output voltage	12 V DC	12 V DC
Output current	3.0 A	5.0 A
Polarity	Shaft: negative, Tip: positive	Shaft: negative, Tip: positive

Battery pack

Description	D Series Lithium-Ion Battery pack
Type	Li-Ion battery pack
Input voltage	12 V DC
Input current	2.5 A
Charge time	5 hours (maximum) at 20°C

12.4

Conductive Rod Technical Data

Conductive rod

Description	Value
Typical detection range	Both modes, line and sonde: Typical 3.0 m/10 ft
Tracing distance	50 m/165 ft; 80 m/263 ft (maximum). Reel length dependant.
Operating transmission frequencies	Dependent on transmitter
Dimensions	440 x 210 x 490 mm/ 17.3 x 8.3 x 19.3 inches
Weight	50 m: 4 kg/8.8 lbs 80 m: 4.7 kg/10.4 lbs

Dimensions

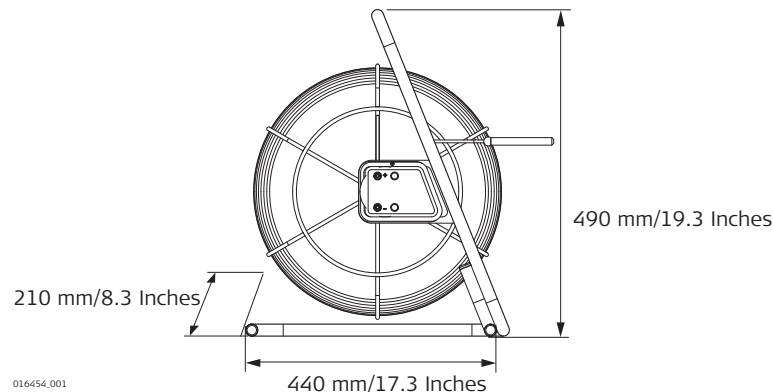

12.5

Property Plug Connector Technical Data

Property plug connector

Mode	Output
Operating transmission frequencies	32.768 (33) kHz
Temperature	Operating -20°C to +50°C, -4°F to +122°F Storage -40°C to +70°C, -40°F to +158°F
Protection against water, dust and sand	IP54 (IEC 60529) Dust-protected
Humidity	95% RH non condensing The effects of condensation are to be effectively counteracted by periodically drying out the product.
Dimensions	100 x 80 mm/3.9 x 3.1 inches

Mode	Output
Weight	0.15 kg/0.3 lbs

Dimensions

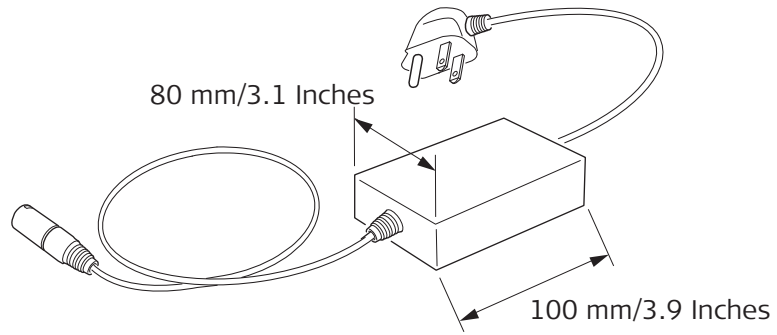

Appendix A

Time Zone Offsets

Time zone offsets

